

Ukufunda ngoMgaqo-siseko weRiphabliki yoMzantsi Afrika (1996)

Umgaqo-siseko weli loMzantsi Afrika (1996) uqulthe eyona mithetho yongameleyo yeli lizwe. Le mithetho ingaphezulu komongameli welizwe, ngaphezulu kweenkundla zamatyala nangaphezulu kukarhulumente.

Le mithetho ichaza indlela abemi beli lizwe abafanele ukuphathana ngayo, nokuba ayintoni amalungelo noxanduva lwabo omnye komnye. Umgaqo-siseko welizwe ukho ukuze usikhusele ngalo mzuzu kwaye ukhusele nabantwana bethu kwixesha elizayo.

Masiyazi imvelaphi yethu.

Masingaphindi iimpazamo zexesha elidlulileyo.

Umgaqo-siseko wethu uyasinceda ukuze sakhe ingomso elingcono lomntu wonke.

Thina, bantu boMzantsi Afrika, Siyaziqonda iimeko zolwaphulo-bulungisa zamaxesha ethu adlulileyo; Sibanika imbeko abo beva ubunzima bebulalekela ubulungisa nenkululeko elizweni lethu; Siyabahlonela abo bathi basebenzela ukwakha nokuphuhlisa ilizwe lethu; kwaye Sikholelwa ekubeni uMzantsi Afrika ngowethu sisonke thina sihlala kuwo, simanyene nangani siziintlobo ngeentlobo. Thina ke ngoko, ngabameli bethu abanyulwe ngokukhululekileyo, siyawuvuma lo mGaqo-siseko ukuba ungowona mithetho wongameleyo weRiphabliki ukuze— Ungcibe udibanise izantlukwano zangaphambili uze wakhe uluntu olusekwe kwizithethe ezixabisekileyo zedemokhrasi, ubulungisa kwezintlobo namalungelo abantu asisiseko; Wenze isiseko soluntu oluphila ngendlela yedemokhrasi nolwenza izinto elubala apho urhulumente asekelwe kwintando yabantu nalapho wonke ummi ekhuselewe ngokulinganayo ngumthetho; Uphucule ixabiso lokuphila kwabo bonke abemi, uze uvumele ukusebenza kwesakhono somntu ngamnye; kanjalo Wakhe uMzantsi Afrika omanyeneyo nonedemokhrasi onakho ukuthabatha indawo yawo efanelekileyo njengelizwe elinobunganga kusapho lwezizwe ngezizwe.

Wabange amalungelo a kho njengommi weli loMzantsi Afrika kwaye nawe uluthathele kuwe uxanduva lokukhusela amalungelo abanye.

Wazi amalungelo akho noxanduva lwakho.

Wanga uThixo angabakhusela abantu bakokwethu. Nkosi Sikelel' iAfrika. Morena boloka setjhaba sa heso. God seën Suid-Afrika. God bless South Africa. Muzimu fhatutshedza Afurika. Hosi katekisa Afrika.



ISBN 978-1-4315-0006-2



**MATHEMATICS IN XHOSA
GRADE 3 – BOOK 1
TERMS 1 & 2
ISBN 978-1-4315-0006-2
THIS BOOK MAY NOT BE SOLD.
14th Edition**



IZIBALO NGESIXHOSA – Ibanga lesi- 3 Incwadi yoku-1

ISBN 978-1-4315-0006-2

Ihlaziyiwe yaze yalungelelaniswa neCAPS



Ibanga lesi- **3**

Igama:

Iklasi:



basic education
Department:
Basic Education
REPUBLIC OF SOUTH AFRICA

IZIBALO NGESIXHOSA

Incwadi yoku-1
Ikota 1 & 2

Iziququlatho

Inani	Isihloko	Iphepha
1	Bala, hlela, ubonise!	2
2	Ukubala ngobuchule	4
3a	Amanani akwibhodi yamakhulu	6
3b	Amanani akwibhodi yamakhulu (asaqhutywa)	8
4	Ixabiso lendawo	10
5	Ukudibanisa nokuthabatha	12
6	Amanani aphindaphindwe kabini neziqingatha	14
7	Amaqhezu	16
8	Ukuhlela imali	18
9	Iipatheni	20
10	Iibhola, iibhokisi kunye neesilinda	22
11	Zoba uze uthiye amagama iimilo ezinemilinganiselo emibini (2D) uze uzithelekise	24
12	Ixesha liyahamba	26
13	Ukulinganisa ubude	28
14	Umtshamo	30
15	Ukusebenza ngobunzima (imasi)	32
16	Ukusebenza ngeenkukacha	34
17	Thelekisa uze ulandelelanise amanani	36
18	Ixabiso lendawo ukuya kuma - 99	38
19	Ukubeka amashumi ndawonye xa sidibanisa ukuya kuma - 99	40
20a	Bala usebenzise umgca - manani	42
20b	Bala usebenzise umgca - manani (kusaqhutywa)	44
21a	Thabatha kumgca - manani	46
21b	Thabatha kumgca - manani (kusaqhutywa)	48
22	Lixesha lepati	50
23	Ukubala uyokufika kuma - 200	52
24	Ziqhelanise nezi - 5	54
25a	Bala ngezi - 2	56
25b	Bala ngezi - 2 (kusaqhutywa)	58
26	Imali yakudala neyangoku	60
27	Bala ngezi - 3	62
28	Ziintoni izinto ezinezi - 4?	64
29	Iipatheni zamanani	66
30a	Ukwahlula	68
30b	Ukwahlula (kusaqhutywa)	70

Inani	Isihloko	Iphepha
31	Amaqhezu	72
32	Malunga nexesha	74
33	Bala ufike kuma - 200	76
34	Ukusebenza ngamaqela amanani	78
35a	Ukubeka amashumi ndawonye nokuwacazulula	80
35b	Ukubeka amashumi ndawonye nokuwacazulula (kusaqhutywa)	82
36	Utyelelo kugqirha wamazinyo	84
37a	Dibanisa uze uqukanise	86
37b	Dibanisa uze uqukanise (kusaqhutywa)	88
38	Sombulula!	90
39	Bala	92
40	Ukulinganisa ngeesentimitha	94
41	Bala ufike kuma - 300	96
42	Ukudibanisa nokuthabatha ngama - 100	98
43	Bala ufike kuma - 400	100
44	Ukulinganisa ubunzima	102
45	Bala ufike kuma - 500	104
46	Okunye ukudibanisa nokuthabatha	106
47	Phucula izakhono zakho	108
48	Umafana twatse	110
49	Ukuya kuma - 500	112
50	Ukuphindaphinda nokwahlula (10)	114
51	Bala ngezibini (2)	116
52	Gangatha ngeethayile	118
53	Sebenzisa izihlanu	120
54	Ukusebenza ngexesha	122
55	Bala ngezi - 3 nangezi - 4	124
56	Bala ngama - 50	126
57	Amaqhezu: iziqingatha neekota	128
58	Amaqhezu: iziqingatha, izithathu nezithandathu	130
59	Amaqhezu: izihlanu	132
60	Izinto ezinemilinganiselo emi - 3 (3D)	134
61	Ukuphinda kabini nokwahlula kubini	136
62	Okunye ngokuphinda kabini nokwahlula kubini	138
63	Qukanisa uze udibanise	140
64	Ukonwaba ngezibalo	142
	Umsiko 1	
	Umsiko 2	



UNksk. Angie Motshekga,
uMphathiswa wemfundo
esisiseko



UGqir. Reginah Mhaule,
uSekela Mphathiswa
wemfundo esiseko

Ezi ncwadi zilungiselelwe abantwana baseMzantsi Afrika phantsi kwephiko loMphathiswa weMfundo esiseko uNksk. Angie Motshekga kunye noSekela Mphathiswa weMfundo esiseko uGqir. Reginah Mhaule.

Ezi ncwadi zokusebenzela, iRainbow Workbooks, lelinye lamalinge ongenelelo eSebe leMfundo esiseko ajo ide ekuphuculeni umgangatho wabafundi beloMzantsi Afrika abakumabanga amathandathu okuqala. Njengomnye wemiba ephambili yoMkhomba-ndlela kaRhulumente, eli phulo libe nempumelelo ngenxa yenkxaso-mali evela kuVimba weSizwe. Oku kuye kwenza ukuba iSebe likwazi ukuvelisa ezi ncwadi, zifumaneke ngazo zonke iilwimi ezisemthethweni ngexabiso eliphantsi.

Sinethemba lokuba ootitshala baya kuzifumana ezi ncwadi zokusebenzela ziluncedo kakhulu kwimfundo yemihla ngemihla, nasekuqinisekiseni ukuba abafundi bayifikelela yonke ikharithyulam. Ukuqinisekisa ukuba utitshala uyakhokelwa kuyo yonke imisetyenzana, sisebenzise izalathisi ezibonisa oko kufanele ukwenziwa ngumfundi.

Sinethemba lokwenene lokuba abantwana baya kukonwabela ukusebenza kwezi ncwadi ekukhuleni nasekufundeni kwabo, kwanokuba nawe titshala uya kwabelana nabo kolu yolo.

Sinqwenela ukuba nibe nempumelelo ekusebenziseni ezi ncwadi.

Ibanga
lesi-3

Rainbow
WORKBOOKS

Imathematika

NGESIXHOSA

Le ncwadi yeka:-

ISIXHOSA

*Incwadi
yoku-*



Umhla:

Bala, hlela, ubonise!

Ikota yoku-1



Zingaphi iinkwenkwezi?

Thelekisa iimpendulo.



Qikelela ukuba zingaphi iinkwenkwezi. _____

Zibale ke ngoku. _____

Fumana ukuba ngubani ophumeleleyo!

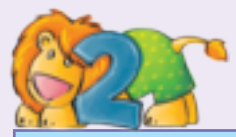

Ngubani oqikelele ngokusondeleyo?

Fakani amagama neempendulo zenu phakathi kule theyibhile.

Igama				
Uqikelelo				
Inani elibaliweyo				
Umahluko phakathi koqikelelo lwakho kunye nenani elibaliweyo				



Iindlela zokubala. Sincedise sibhale phantsi.



Ndibale ngoononye

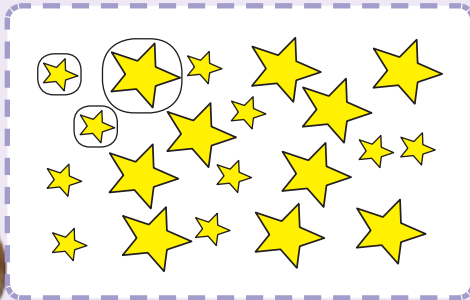

1, 2, 3, _____

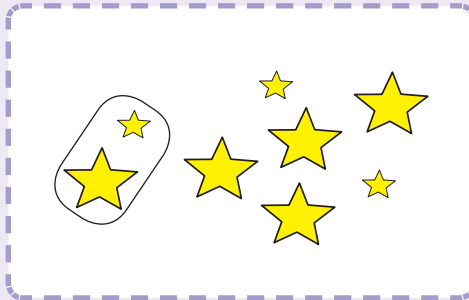

2, _____



Ndibale ngezibini.



Ndibale ngezihlanu.

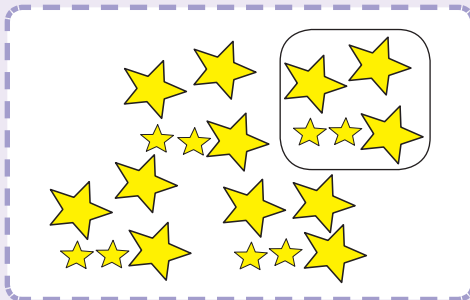

5, _____





Ndibale ngamashumi.



Bhala izivakalisi zamanani.

Bala inani leenkwenkwezi ezinkulu nezincinci ezikumfanekiso okwiphapha 2.

Zibhale ngeendlela ezimbini.

Inkulu Incinci Ngolu hlobo

okanye

ngolu hlobo



nanjengesivakalisi samanani.

_____ + _____ = _____

okanye



_____ + _____ = _____

Ayinemsebenzi indlela alandelelana ngayo amanani xa udibanisa nokuba ngawaphi na amanani amabini.



Teacher: _____
Sign: _____
Date: _____



Ukubala ngobuchule

Bala amathanga.

Fumana indlela elula yokwabala.

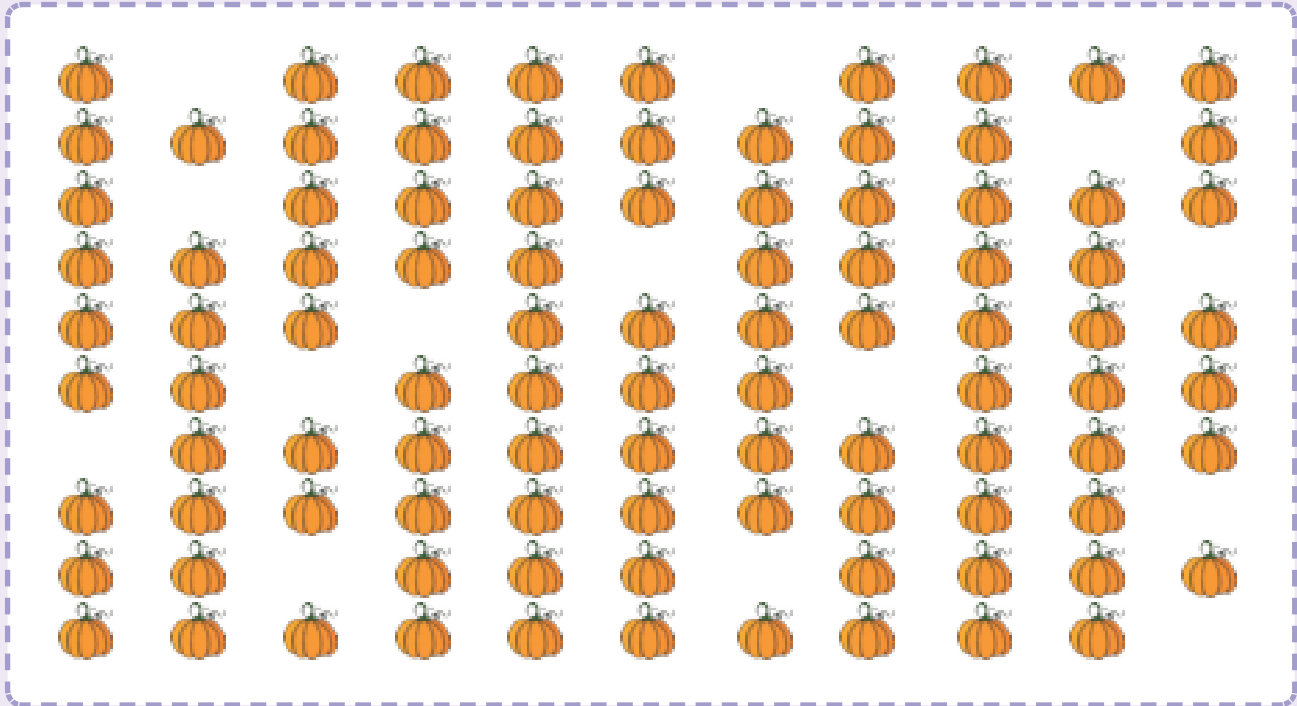

Impendulo: _____



Pakisha amathanga

Amathanga alishumi angena engxoweni enye.



Zingaphi iingxowa ezinokuzaliswa ngala mathanga? _____

Mangaphi amathanga ashiyekileyo? _____

Mangaphi amathanga asafunekayo ukuze kuzale enye ingxowa? _____



Ukusuka ku + ukuya ku × (Ukudibanisa nokuphinda-phinda)

Gqibezela izivakalisi - manani.

Umzekelo:

$$10 + 10 + 10 + 10 = 40 \Rightarrow \text{amaqela ama-4 ama-10} = 40 \Rightarrow 4 \times 10 = 40$$



a. $10 + 10 + 10 = \underline{\hspace{2cm}}$

amaqela ama- $\underline{\hspace{1cm}}$ ama-10 = $\underline{\hspace{1cm}}$ \Rightarrow $\underline{\hspace{1cm}} \times \underline{\hspace{1cm}} = \underline{\hspace{1cm}}$



b. $10 + 10 + 10 + 10 + 10 + 10 + 10 + 10 = \underline{\hspace{2cm}}$

amaqela ama- $\underline{\hspace{1cm}}$ ama-10 = $\underline{\hspace{1cm}}$ \Rightarrow $\underline{\hspace{1cm}} \times \underline{\hspace{1cm}} = \underline{\hspace{1cm}}$



Izandla neminwe



Zingaphi izandla? $\underline{\hspace{2cm}}$

Mingaphi iminwe? $\underline{\hspace{2cm}}$

Bhala impendulo yakho ngeendlela ezi-2.

amaqela ama- $\underline{\hspace{1cm}}$ ama-10 = $\underline{\hspace{1cm}}$ okanye $\underline{\hspace{1cm}} \times 10 = \underline{\hspace{1cm}}$



Teacher: _____
 Sign: _____
 Date: _____

3a

Umhla:

Amanani akwibhodi yamakhulu



Amanani athethayo

Bala uxele amanani onke ukusukela ku-1 ukuya kwi-100.

Yalatha njengokuba usiya phambili.

1	2	3	4	5	6		8	9	10
11									
						27			
			34						40
41									
				55					
		63							
71									
					86				
			94						100



- Bhala amanani ashiyelelweyo kwibloko nganye ezuba.
- Bhala amanye amanani.
- Amanani amthubi aloluphi uhlobo lwamanani?



Bhala la manani ngamagama.

90	amashumi alithoba	41	
77		56	
14		65	

Ikota yoku-1



Ukubala nokufaka imibala

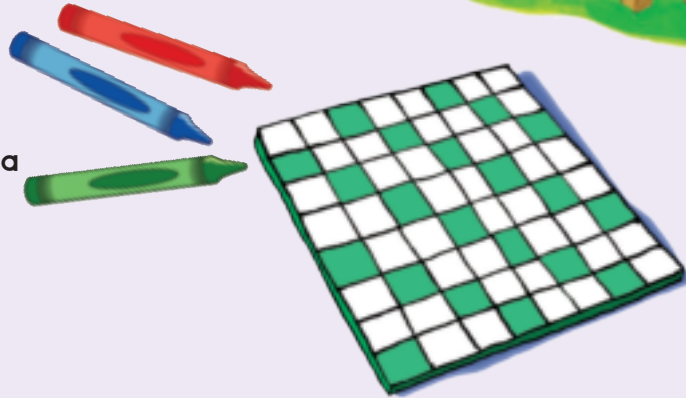

Lungela ukubala imibala!

<table border="1"> <tr><td>1</td><td>2</td><td>3</td><td>4</td><td>5</td><td>6</td><td>7</td><td>8</td><td>9</td><td>10</td></tr> <tr><td>11</td><td>12</td><td>13</td><td>14</td><td>15</td><td>16</td><td>17</td><td>18</td><td>19</td><td>20</td></tr> <tr><td>21</td><td>22</td><td>23</td><td>24</td><td>25</td><td>26</td><td>27</td><td>28</td><td>29</td><td>30</td></tr> <tr><td>31</td><td>32</td><td>33</td><td>34</td><td>35</td><td>36</td><td>37</td><td>38</td><td>39</td><td>40</td></tr> <tr><td>41</td><td>42</td><td>43</td><td>44</td><td>45</td><td>46</td><td>47</td><td>48</td><td>49</td><td>50</td></tr> <tr><td>51</td><td>52</td><td>53</td><td>54</td><td>55</td><td>56</td><td>57</td><td>58</td><td>59</td><td>60</td></tr> <tr><td>61</td><td>62</td><td>63</td><td>64</td><td>65</td><td>66</td><td>67</td><td>68</td><td>69</td><td>70</td></tr> <tr><td>71</td><td>72</td><td>73</td><td>74</td><td>75</td><td>76</td><td>77</td><td>78</td><td>79</td><td>80</td></tr> <tr><td>81</td><td>82</td><td>83</td><td>84</td><td>85</td><td>86</td><td>87</td><td>88</td><td>89</td><td>90</td></tr> <tr><td>91</td><td>92</td><td>93</td><td>94</td><td>95</td><td>96</td><td>97</td><td>98</td><td>99</td><td>100</td></tr> </table>	1	2	3	4	5	6	7	8	9	10	11	12	13	14	15	16	17	18	19	20	21	22	23	24	25	26	27	28	29	30	31	32	33	34	35	36	37	38	39	40	41	42	43	44	45	46	47	48	49	50	51	52	53	54	55	56	57	58	59	60	61	62	63	64	65	66	67	68	69	70	71	72	73	74	75	76	77	78	79	80	81	82	83	84	85	86	87	88	89	90	91	92	93	94	95	96	97	98	99	100	<table border="1"> <tr><td>1</td><td>2</td><td>3</td><td>4</td><td>5</td><td>6</td><td>7</td><td>8</td><td>9</td><td>10</td></tr> <tr><td>11</td><td>12</td><td>13</td><td>14</td><td>15</td><td>16</td><td>17</td><td>18</td><td>19</td><td>20</td></tr> <tr><td>21</td><td>22</td><td>23</td><td>24</td><td>25</td><td>26</td><td>27</td><td>28</td><td>29</td><td>30</td></tr> <tr><td>31</td><td>32</td><td>33</td><td>34</td><td>35</td><td>36</td><td>37</td><td>38</td><td>39</td><td>40</td></tr> <tr><td>41</td><td>42</td><td>43</td><td>44</td><td>45</td><td>46</td><td>47</td><td>48</td><td>49</td><td>50</td></tr> <tr><td>51</td><td>52</td><td>53</td><td>54</td><td>55</td><td>56</td><td>57</td><td>58</td><td>59</td><td>60</td></tr> <tr><td>61</td><td>62</td><td>63</td><td>64</td><td>65</td><td>66</td><td>67</td><td>68</td><td>69</td><td>70</td></tr> <tr><td>71</td><td>72</td><td>73</td><td>74</td><td>75</td><td>76</td><td>77</td><td>78</td><td>79</td><td>80</td></tr> <tr><td>81</td><td>82</td><td>83</td><td>84</td><td>85</td><td>86</td><td>87</td><td>88</td><td>89</td><td>90</td></tr> <tr><td>91</td><td>92</td><td>93</td><td>94</td><td>95</td><td>96</td><td>97</td><td>98</td><td>99</td><td>100</td></tr> </table>	1	2	3	4	5	6	7	8	9	10	11	12	13	14	15	16	17	18	19	20	21	22	23	24	25	26	27	28	29	30	31	32	33	34	35	36	37	38	39	40	41	42	43	44	45	46	47	48	49	50	51	52	53	54	55	56	57	58	59	60	61	62	63	64	65	66	67	68	69	70	71	72	73	74	75	76	77	78	79	80	81	82	83	84	85	86	87	88	89	90	91	92	93	94	95	96	97	98	99	100	<table border="1"> <tr><td>1</td><td>2</td><td>3</td><td>4</td><td>5</td><td>6</td><td>7</td><td>8</td><td>9</td><td>10</td></tr> <tr><td>11</td><td>12</td><td>13</td><td>14</td><td>15</td><td>16</td><td>17</td><td>18</td><td>19</td><td>20</td></tr> <tr><td>21</td><td>22</td><td>23</td><td>24</td><td>25</td><td>26</td><td>27</td><td>28</td><td>29</td><td>30</td></tr> <tr><td>31</td><td>32</td><td>33</td><td>34</td><td>35</td><td>36</td><td>37</td><td>38</td><td>39</td><td>40</td></tr> <tr><td>41</td><td>42</td><td>43</td><td>44</td><td>45</td><td>46</td><td>47</td><td>48</td><td>49</td><td>50</td></tr> <tr><td>51</td><td>52</td><td>53</td><td>54</td><td>55</td><td>56</td><td>57</td><td>58</td><td>59</td><td>60</td></tr> <tr><td>61</td><td>62</td><td>63</td><td>64</td><td>65</td><td>66</td><td>67</td><td>68</td><td>69</td><td>70</td></tr> <tr><td>71</td><td>72</td><td>73</td><td>74</td><td>75</td><td>76</td><td>77</td><td>78</td><td>79</td><td>80</td></tr> <tr><td>81</td><td>82</td><td>83</td><td>84</td><td>85</td><td>86</td><td>87</td><td>88</td><td>89</td><td>90</td></tr> <tr><td>91</td><td>92</td><td>93</td><td>94</td><td>95</td><td>96</td><td>97</td><td>98</td><td>99</td><td>100</td></tr> </table>	1	2	3	4	5	6	7	8	9	10	11	12	13	14	15	16	17	18	19	20	21	22	23	24	25	26	27	28	29	30	31	32	33	34	35	36	37	38	39	40	41	42	43	44	45	46	47	48	49	50	51	52	53	54	55	56	57	58	59	60	61	62	63	64	65	66	67	68	69	70	71	72	73	74	75	76	77	78	79	80	81	82	83	84	85	86	87	88	89	90	91	92	93	94	95	96	97	98	99	100
1	2	3	4	5	6	7	8	9	10																																																																																																																																																																																																																																																																																																					
11	12	13	14	15	16	17	18	19	20																																																																																																																																																																																																																																																																																																					
21	22	23	24	25	26	27	28	29	30																																																																																																																																																																																																																																																																																																					
31	32	33	34	35	36	37	38	39	40																																																																																																																																																																																																																																																																																																					
41	42	43	44	45	46	47	48	49	50																																																																																																																																																																																																																																																																																																					
51	52	53	54	55	56	57	58	59	60																																																																																																																																																																																																																																																																																																					
61	62	63	64	65	66	67	68	69	70																																																																																																																																																																																																																																																																																																					
71	72	73	74	75	76	77	78	79	80																																																																																																																																																																																																																																																																																																					
81	82	83	84	85	86	87	88	89	90																																																																																																																																																																																																																																																																																																					
91	92	93	94	95	96	97	98	99	100																																																																																																																																																																																																																																																																																																					
1	2	3	4	5	6	7	8	9	10																																																																																																																																																																																																																																																																																																					
11	12	13	14	15	16	17	18	19	20																																																																																																																																																																																																																																																																																																					
21	22	23	24	25	26	27	28	29	30																																																																																																																																																																																																																																																																																																					
31	32	33	34	35	36	37	38	39	40																																																																																																																																																																																																																																																																																																					
41	42	43	44	45	46	47	48	49	50																																																																																																																																																																																																																																																																																																					
51	52	53	54	55	56	57	58	59	60																																																																																																																																																																																																																																																																																																					
61	62	63	64	65	66	67	68	69	70																																																																																																																																																																																																																																																																																																					
71	72	73	74	75	76	77	78	79	80																																																																																																																																																																																																																																																																																																					
81	82	83	84	85	86	87	88	89	90																																																																																																																																																																																																																																																																																																					
91	92	93	94	95	96	97	98	99	100																																																																																																																																																																																																																																																																																																					
1	2	3	4	5	6	7	8	9	10																																																																																																																																																																																																																																																																																																					
11	12	13	14	15	16	17	18	19	20																																																																																																																																																																																																																																																																																																					
21	22	23	24	25	26	27	28	29	30																																																																																																																																																																																																																																																																																																					
31	32	33	34	35	36	37	38	39	40																																																																																																																																																																																																																																																																																																					
41	42	43	44	45	46	47	48	49	50																																																																																																																																																																																																																																																																																																					
51	52	53	54	55	56	57	58	59	60																																																																																																																																																																																																																																																																																																					
61	62	63	64	65	66	67	68	69	70																																																																																																																																																																																																																																																																																																					
71	72	73	74	75	76	77	78	79	80																																																																																																																																																																																																																																																																																																					
81	82	83	84	85	86	87	88	89	90																																																																																																																																																																																																																																																																																																					
91	92	93	94	95	96	97	98	99	100																																																																																																																																																																																																																																																																																																					
Bala uze ugqume ama-10.	Ku-0 ukuya kwi-100. Bala uze ugqume izi-5 ukusukela ku-0 ukuya kwi-100.	Bala ugqume izi-2.																																																																																																																																																																																																																																																																																																												
Bala ngama-10 ukusuka ku-10 ukuya kwi-100.	Bala ngezi-5 ukusuka ku-5 ukuya kwi-100.	Bala ngezi-2 ukusuka ku-2 ukuya kwi-100.																																																																																																																																																																																																																																																																																																												
Bhala ama-10 ukusuka ku-10 ukuya kwi-100.	Bhala izi-5 ukusuka kwisi-5 ukuya kuma-80.	Bhala izi-2 ukusuka kwisi-2 ukuya kwi-100.																																																																																																																																																																																																																																																																																																												



Teacher: _____
Sign: _____
Date: _____

11 12 13 14 15 16 17 18 19 20

Amanani akwibhodi yamakhulu (asaqhutywa)

Ikota yoku-1



Funa iipatheni

1	2	3	4	5	6	7	8	9	10
11	12	13	14	15	16	17	18	19	20
21	22	23	24	25	26	27	28	29	30
31	32	33	34	35	36	37	38	39	40
41	42	43	44	45	46	47	48	49	50
51	52	53	54	55	56	57	58	59	60
61	62	63	64	65	66	67	68	69	70
71	72	73	74	75	76	77	78	79	80
81	82	83	84	85	86	87	88	89	90
91	92	93	94	95	96	97	98	99	100

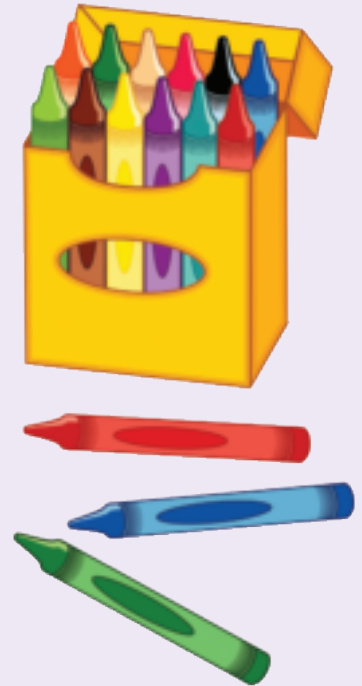

Phawula onke ama-10.

Phawula zonke izi-5.

Phawula zonke izi-2.

Bhala amanani abhalwe ngeepatheni zezi-2 nezi-5.



Bala iipatheni

Fakela amanani ashiyelelweyo.

0; 10; 20; _____; _____; 50; _____; _____; 80; _____; 100; _____;
 _____; 130; _____; _____; 160; _____; _____; _____; 200

0; 5; 10; _____; _____; 25; _____; _____; 40; _____; 50; 55; _____;
 _____; 70; _____; _____; 85; _____; _____; 100

0; 2; 4; 6; _____; _____; 12; _____; _____; 18; _____; 22; 24; _____;
 _____; 30; _____; _____; 36; 38; _____; _____; _____; 46; _____;

0; _____; 8; _____; 16; 20; _____; 28; _____; 36; _____; _____;
 _____; 52; _____; _____; 64; _____; 72; _____; 80

0; _____; 10; _____; 20; _____; 30; _____; 40; _____; _____; 55;
 60; _____; 70; 75; _____; 85; _____; _____; 100

0; 3; _____; 9; _____; 15; 18; _____; 24; _____; _____; 33; _____; 39;
 _____; 45; _____; _____; 54; 57; _____; 63; _____; _____; 72; 75

Teacher: _____
 Sign: _____
 Date: _____

Umhla:

4

Ixabiso lendawo

Ikota yoku-1



Bonisa amanani akho

Sika amakhadi amanani kumsiko woku-1.
Sebenzisa amakhadi wakhe amanani.

19

43

69

54

35

1	0
	9



19		<table border="1"> <tr> <td>1</td> <td>0</td> </tr> <tr> <td></td> <td>9</td> </tr> </table>	1	0		9	$10 + 9 = 19$
1	0						
	9						

43		<table border="1"> <tr> <td>1</td> <td>0</td> </tr> <tr> <td>1</td> <td>0</td> </tr> <tr> <td>1</td> <td>0</td> </tr> <tr> <td>1</td> <td>0</td> </tr> <tr> <td></td> <td>3</td> </tr> </table>	1	0	1	0	1	0	1	0		3	$40 + 3 = 43$
1	0												
1	0												
1	0												
1	0												
	3												

Zenzele ngokwakho kula manani usebenzise umsiko woku-1.

54	
----	--

35	
----	--

69	
----	--



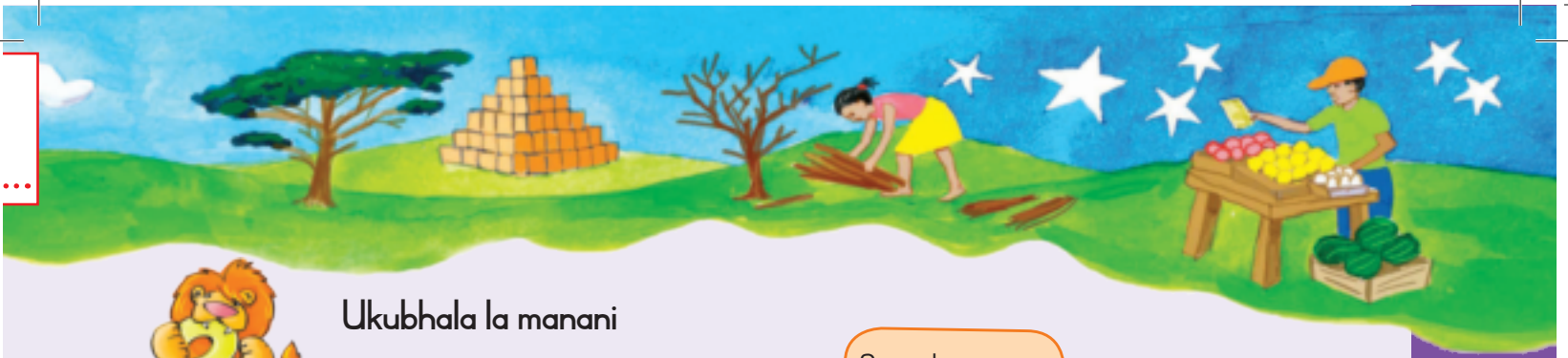

Ukubhala la manani

Sikwenzele eyokuqala.

Singathi oononye abali-9

19	$10 + 9$	ishumi eli-1 + imivo eli-9	ishumi elinethoba
43			
69			
54			
35			
21			
73			
44			
32			
89			
17			
95			
56			
68			
67			



Bhala amanani okuqala amahlanu kwithejibhile engentla ngokulandelelana, uqale kwelona lincinci uye kwelona likhulu.

_____ ; _____ ; _____ ; _____ ; _____

Teacher: _____
 Sign: _____
 Date: _____

Ukudibanisa nokuthabatha



ULebo mde

ULebo unepakethe zama-apile ezili-19 ekuseni.

Ushiyekelwa ziipakethe ezili-13 ngexesha lesidlo sasemini.



a. Uthengise iipakethe ezingaphi uLebo? _____

b. Bhala impendulo yakho ibe sisivakalisi samanani.

_____ - _____ = _____

Bhala ezinye izivakalisi zamanani ezihlanu ubonise kwale mpendulo inye.

$15 - 9 = 6$ _____



Ukuziqhelisa amanani

Bhala iimpindulo.

$$1 + 2 = 3$$

Sebenzisa ...

+ - =

$10 + 5 = \square$	$11 + 6 = \square$	$14 - 9 = \square$	$14 - 8 = \square$
$11 + 5 = \square$	$17 + 2 = \square$	$19 - 7 = \square$	$14 - 5 = \square$
$12 + 6 = \square$	$3 + 13 = \square$	$16 - 5 = \square$	$16 - 13 = \square$
$17 + 2 = \square$	$4 + 15 = \square$	$15 - 10 = \square$	$19 - 7 = \square$



Amanani azalanayo

5

9

14

Nantsi imizekelo yolu sapho lwamanani.

$9 + 5 = \underline{14}$	$5 + 9 = \underline{14}$
$\underline{14} - 9 = 5$	$\underline{14} - 5 = 9$



Ungakwazi ukufumana onke amanani osapho lwe-14?

$1 + 13 = 14$	$13 + 1 = 14$	$14 - 1 = 13$	$14 - 13 = 1$
$2 + 12 =$			
$3 + 11 =$			
$4 + 10 =$			
$5 + 9 =$			
$6 + 8 =$			
$7 + 7 =$			



Ndiza kwenza ngokufanayo nge-12.

12

$1 + 11 = 12$			
$2 + 10 = 12$			
$3 + 9 = 12$			
$4 + 8 = 12$			
$5 + 7 = 12$			
$6 + 6 = 12$			



Teacher: _____
 Sign: _____
 Date: _____

11 12 13 14 15 16 17 18 19 20

6

Umhla:

Amanani aphindaphindwe kabini neziqingatha

Ikota yoku-1

Usakhumbula?

u-2 sisiqingatha sika-4

u-4 ngu-2 ophindwe kabini

ama-20 sisiqingatha sama-40

ama-40 ngama -20 ophindwe kabini

Oku singakubonisa ngomzobo ...

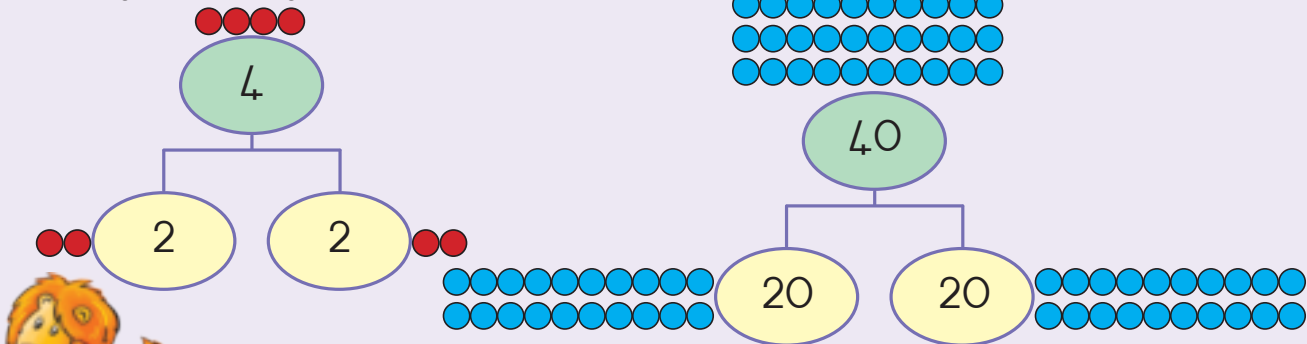

Funa amanani aphinda-phindwe kabini okanye iziqingatha

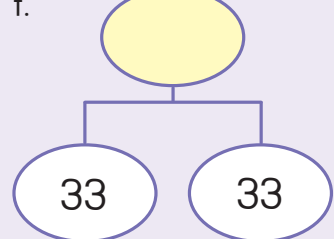
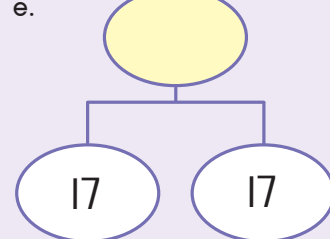
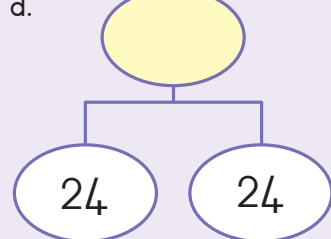
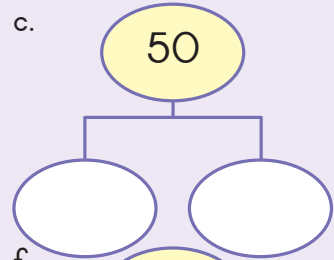
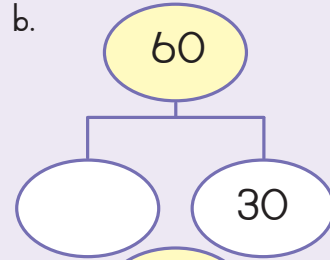
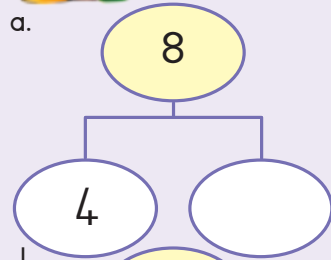

Umngeni

Nika isiqingatha sesi-3.

Bonisa ngokwenani okanye igama lenani. Umzobo ungakunceda.



Phinda inani kabini usebenzise umgca manani.
Sikwenzele umzekelo wokuqala.

a. Phinda isi-4 kabini

$$\boxed{4} + \boxed{4} = \boxed{8}$$

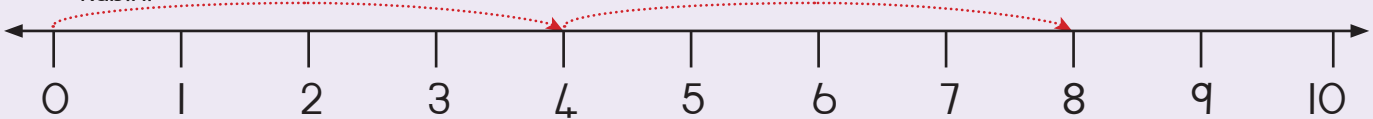

b. Phinda isi-5 kabini

$$\boxed{} + \boxed{} = \boxed{}$$



c. Phinda ama-20 kabini

$$\boxed{} + \boxed{} = \boxed{}$$

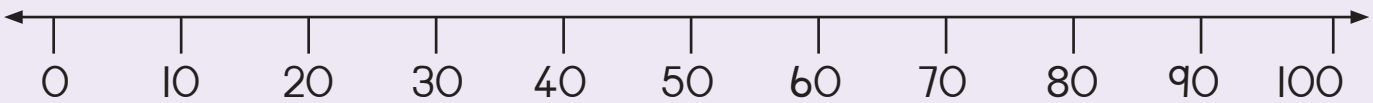

d. Phinda ama-40 kabini

$$\boxed{} + \boxed{} = \boxed{}$$

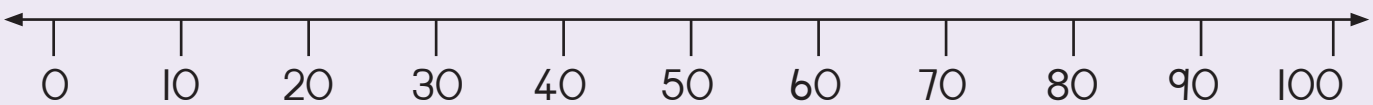

Gqibezela oku

a. Phinda u-1 kabini	2
b. Phinda isi-6 kabini	
c. Phinda i-10 kabini	
d. Phinda ama-30 kabini	
e. Phinda ama-50 kabini	



Gqibezela oku

a. Yahlula kubini isi-6	3
b. Yahlula kubini isi-8	
c. Yahlula kubini i-14	
d. Yahlula kubini ama-60	
e. Yahlula kubini ama-70	



Teacher: _____
Sign: _____
Date: _____

Amaqhezu

Fakela umbala obomvu kwikota yeebhaluni uze ufakele ozuba kwezishiyekileyo.
Faka umbala obomvu kwisiqingatha sebhokisi nganye.



Jonga iimilo. Phawula (✓) iimilo ezibonisa iziqingatha.

Fakela umbala kwisiqingatha semilo nganye eyahlulwe kabini.

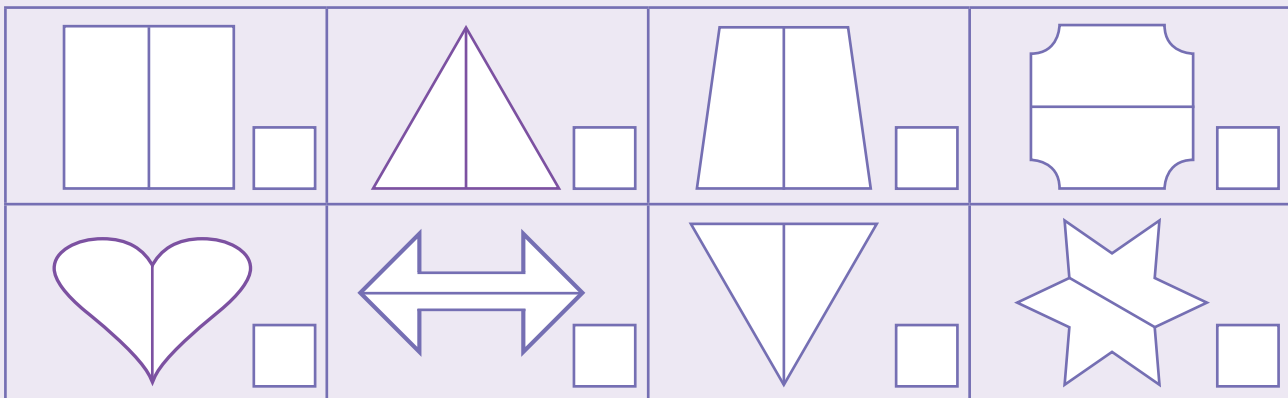
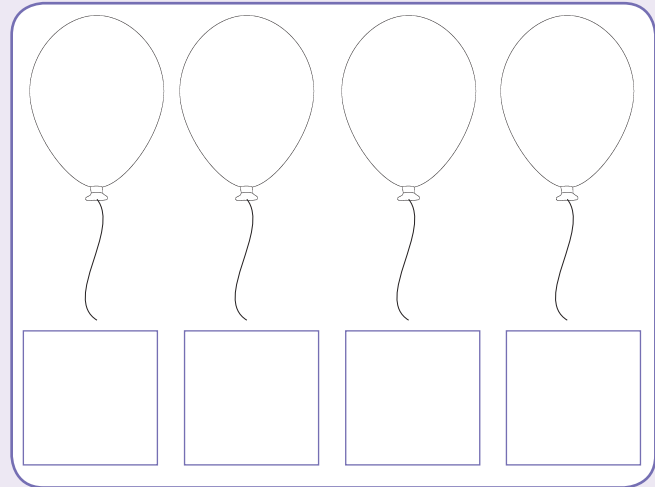

Jonga iimilo. Phawula (✓) iimilo ezibonisa iikota.

Fakela umbala kwikota yemilo nganye eyahlulwe yaziikota ezilinganayo.

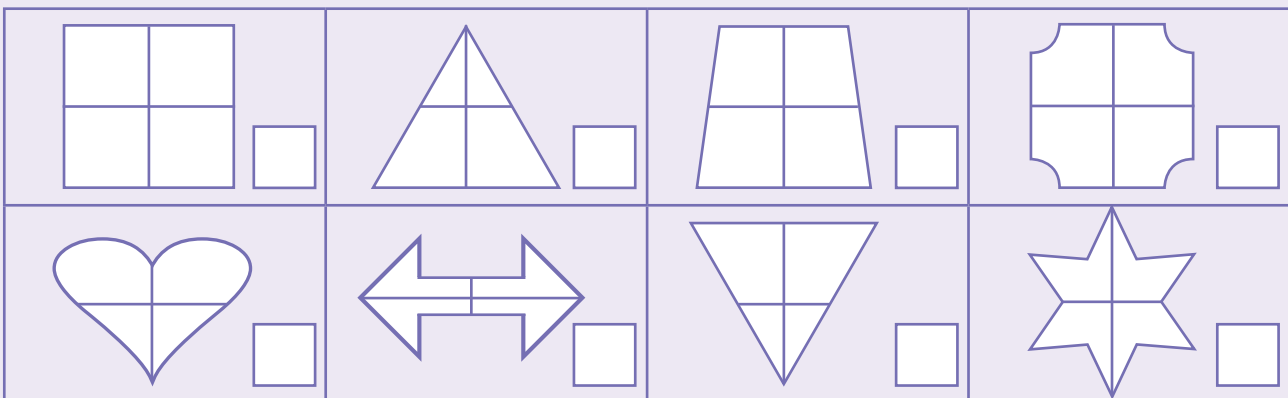



Fakela umbala kwisiqingatha seemilo. Yintoni isiqingatha senani leemilo?

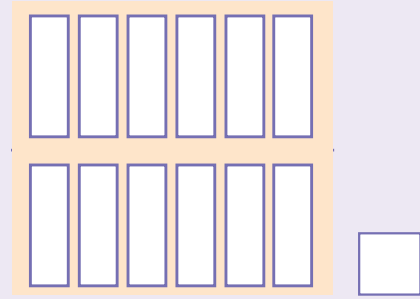
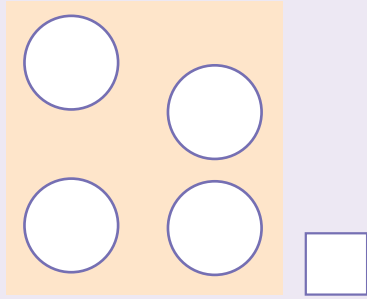
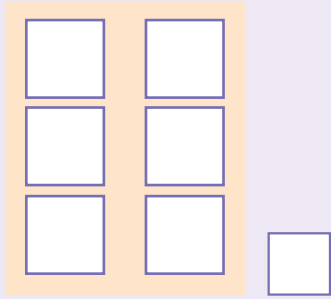

Fakela umbala kwikota yeemilo. Yintoni ikota yenani leemilo?

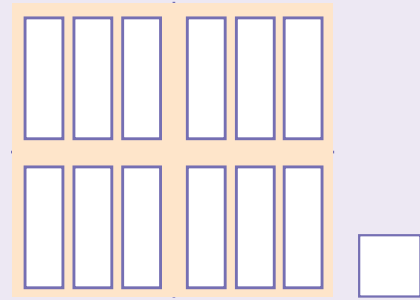
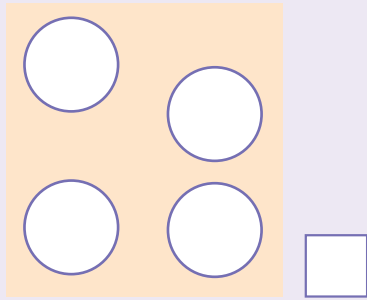
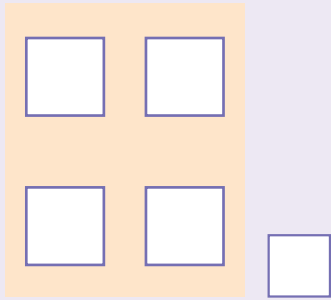

Bhala ngokophawu lweqhezu.

iziqingatha

iikota



Zoba ezinye iimilo wenze isiqingatha ngasinye silingane.

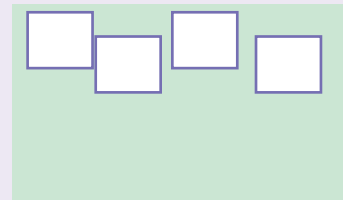
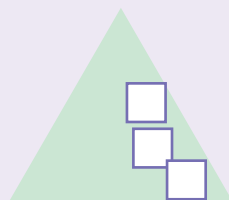
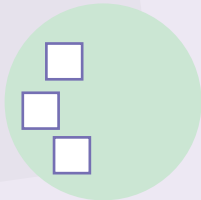

Zoba ezinye iimilo wenze ikota nganye ilingane.

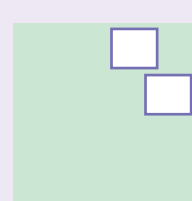
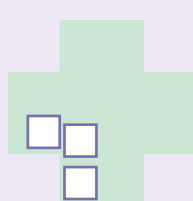
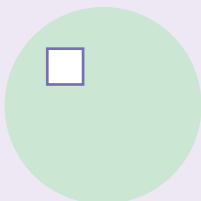

Teacher: _____
Sign: _____
Date: _____

Ukuhlela imali



Umgalelo

UMaLubisi ubala aze ahlele imali ayifumene kwiqela.



Qikelela imali edityanisiweyo. R _____

Bala imali. R _____

Thelekisa uqikelelo kunye neetotali.



Ukugcina imali

UGugu ugcina imali yokuthenga izihlangu ezixabisa ama-R89. Unesiqingatha sale mali okwangoku. Kusafuneka abe namalini? Bhala isivakalisi samanani ubonise impendulo yakho.





Ebhankini

UMaria uhlela imali engamaphepha ibe ziziqhuma ezili-5.
Unenye imali engamaphepha eshiyekileyo.
Bhala imali iyonke kumqolo ngamnye.



Iyonke	
	R _____
	R _____
	R _____



Umngeni

Utyelelo kumzi wezilwanyana

Abanye abantu kunye nabantwana baya kumzi wezilwanyana. Bathenga amatikiti axabisa ama-R90.

Bangaphi abantwana? _____

Bangaphi abantu abadala? _____

Ingaba ikhona enye impedulo?

Abantu abadala _____ Abantwana _____

Teacher: _____
Sign: _____
Date: _____

9

Umhla:

Iipatheni

Ikota yoku-1



Sebenzisa le bhodi yamanani angama-200 ukuze uphendule le mibuzo.

1	2	3	4	5	6	7	8	9	10
11	12	13	14	15	16	17	18	19	20
21	22	23	24	25	26	27	28	29	30
31	32	33	34	35	36	37	38	39	40
41	42	43	44	45	46	47	48	49	50
51	52	53	54	55	56	57	58	59	60
61	62	63	64	65	66	67	68	69	70
71	72	73	74	75	76	77	78	79	80
81	82	83	84	85	86	87	88	89	90
91	92	93	94	95	96	97	98	99	100
101	102	103	104	105	106	107	108	109	110
111	112	113	114	115	116	117	118	119	120
121	122	123	124	125	126	127	128	129	130
131	132	133	134	135	136	137	138	139	140
141	142	143	144	145	146	147	148	149	150
151	152	153	154	155	156	157	158	159	160
161	162	163	164	165	166	167	168	169	170
171	172	173	174	175	176	177	178	179	180
181	182	183	184	185	186	187	188	189	190
191	192	193	194	195	196	197	198	199	200



Sebenzisa ibhodi yamanani angama-200 ukuze ugqibezele amanani amane alandela kwezi patheni zamanani. Emva koko faka umbala kwipatheni ekwibhodi yamanani.

105, 110, 115, _____	87, 90, 93, _____
36, 40, 44, _____	184, 186, 188, _____
70, 65, 60, _____	138, 135, 132, _____
180, 176, 172, _____	14, 12, 10, _____



Bhala amanani alandelayo kwipatheni nganye.
Wakugqiba faka umbala kwipatheni leyo. Uqaphela ntoni ngamanani anombala ofanayo?

Ukubala ngezihlanu.

		5			10

Ukubala ngezibini.

2	4				

Ukubala ngezithathu.

	3		6		

Ukubala ngamashumi.

						10



Yandisa ipatheni.

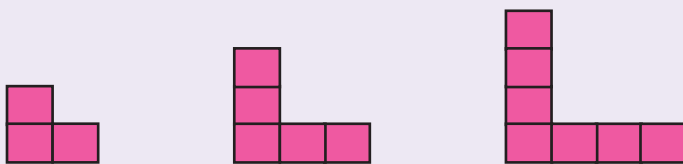

Teacher: _____

Sign: _____

Date: _____

10

Umhla:

Iibhola, iibhokisi kunye neesilinda

Ikota yoku-1



Biyela ngesangqa iibhokisi zibe zuba, iibhola zibe bomvu ze iisilinda zibe luhlaza.



Fakela umbala kwimpendulo echanekileyo.



Ibhokisi



Isilinda



Ibhola

iyatyibilika

iyaqengqeleka

iyatyibilika

iyaqengqeleka

iyatyibilika

iyaqengqeleka

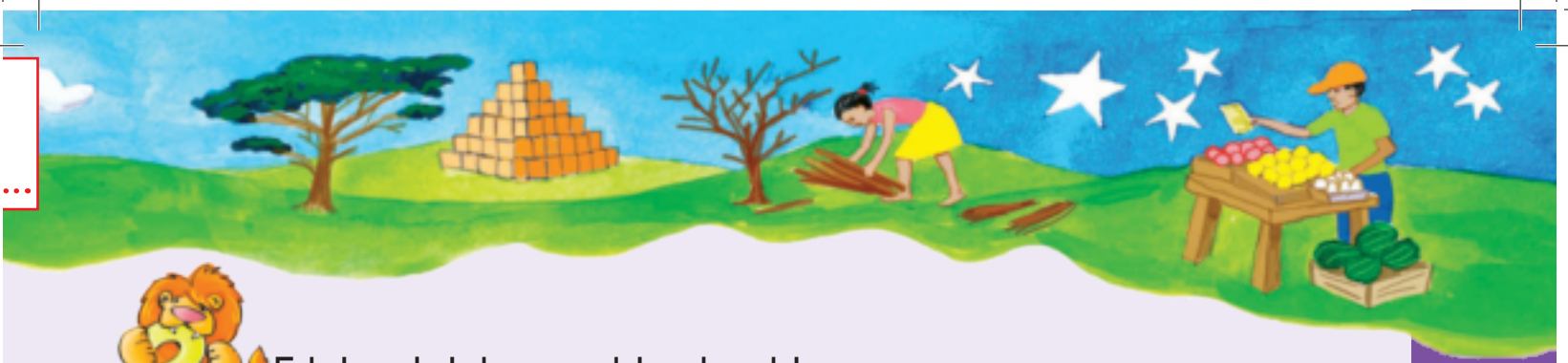

Fakela umbala kwimpendulo echanekileyo.



isiphelo esingqukuva

isiphelo esithe tye



isiphelo esingqukuva

isiphelo esithe tye



isiphelo esingqukuva

isiphelo esithe tye



isiphelo esingqukuva

isiphelo esithe tye



isiphelo esingqukuva

isiphelo esithe tye



isiphelo esingqukuva

isiphelo esithe tye



isiphelo esingqukuva

isiphelo esithe tye



isiphelo esingqukuva

isiphelo esithe tye



Chaza ukuba iphi na le toti. Ingaphambili, isecaleni okanye ingaphezulu kwebhokisi?



ingasemva	ingaphambili
isecaleni	ingaphezulu



ingasemva	ingaphambili
isecaleni	ingaphezulu



ingasemva	ingaphambili
isecaleni	ingaphezulu



ingasemva	ingaphambili
isecaleni	ingaphezulu

Teacher: _____

Sign: _____

Date: _____

Umhla:

Ikota yoku-1

Zoba uze uthiye amagama iimilo ezinemilinganiselo emibini (2D) uze uzithelekise.



Zoba iimilo

Unxantathu

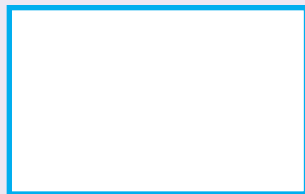

Isangqa



Isikwere



uxande



Bala iimilo

Bala ukuba ufumana iimilo ezingaphi ezifana nezi kulo mfanekiso.

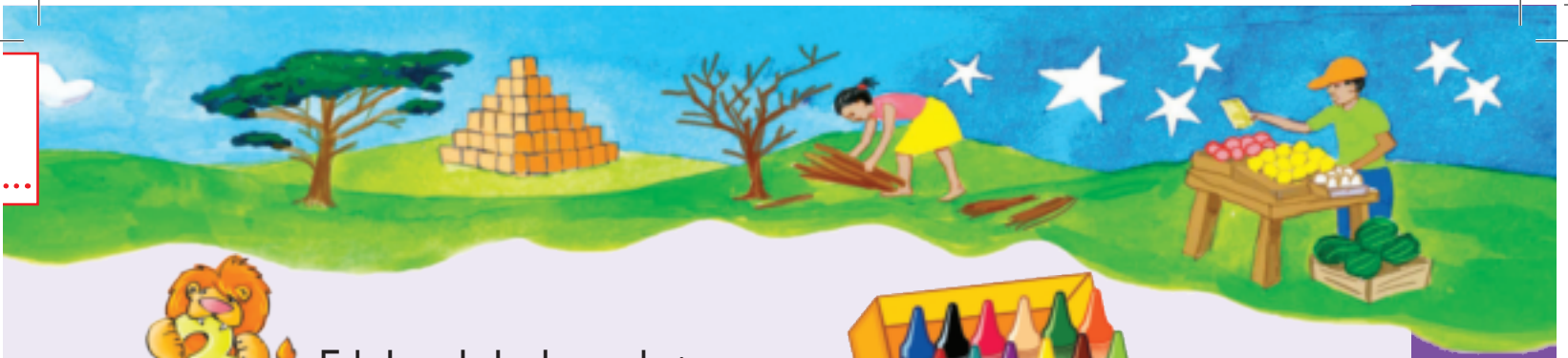

Fakela umbala obomvu kwizangqa



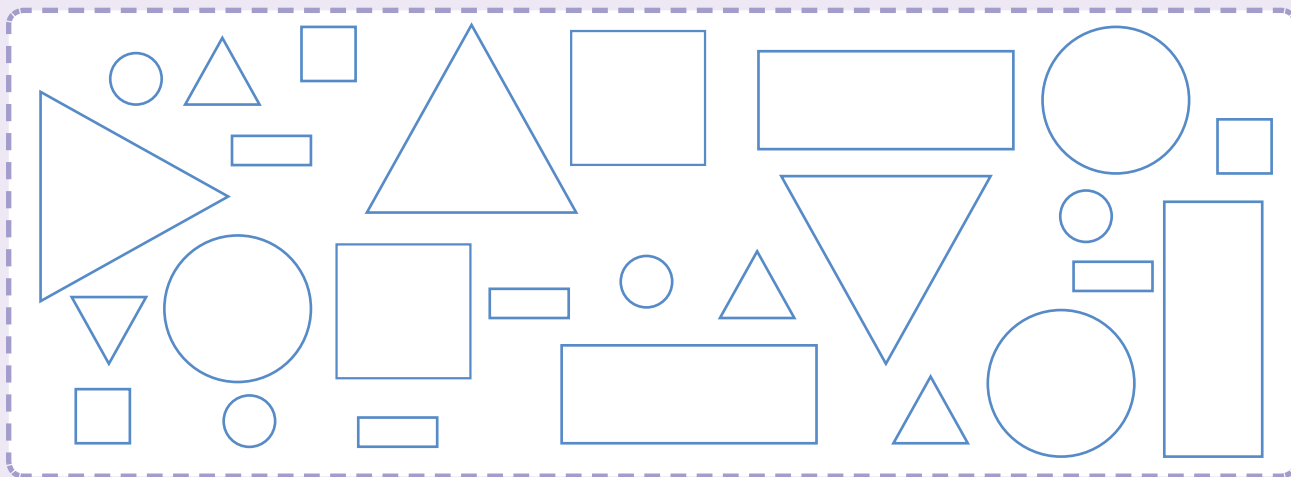



ezikhulu, oluhlaza kwezincinci; ozuba koonxantathu abakhulu, o-orenji kwabancinci; omthubi kwizikwere ezikhulu, omsobo kwezincinci; omdaka kwiingxande ezinkulu nopinki kwezincinci.

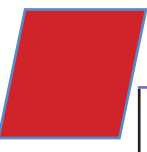

Mangaphi amacala?

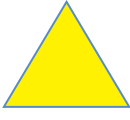
Mangaphi amacala akwimilo nganye?

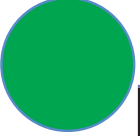
Bhala inani eblokweni. Sikwenzele umzekelo omnye. Ingaba amacala athe tye okanye angqukuva? Fakela umbala kwimpendulo echanekileyo.

	3						
ithe tye	ingqukuva	ithe tye	ingqukuva	ithe tye	ingqukuva	ithe tye	ingqukuva
							
ithe tye	ingqukuva	ithe tye	ingqukuva	ithe tye	ingqukuva	ithe tye	ingqukuva

Teacher: _____
 Sign: _____
 Date: _____

Ixesha liyahamba



Funda ixesha

Zibonisa awaphi amaxesha ezi wotshi?



_____ nkqo entloko _____ nkqo entloko _____ nkqo entloko _____ nkqo entloko



Tsiba-tsiba ujikeleze iwotshi

Ncedisa uMpukwana abale imizuzu ngezi-5.
Qala kwi-12. Jikeleza.



Ubale imizuzu emingaphi? _____

Mingaphi imizuzu kwiyure enye? _____



Bhala ixesha

Zoba amasiba ubonise amaxesha.



umkhono emva
kweyesi-6



icala emva
kweyesi-8



umkhono phambi
kweye-11



licala emva
kweyesi-5



UTumi uya esikolweni.



Umka ekhaya.



Uyafika esikolweni.

Uthatha ixesha elingakanani uTumi? _____



Usuku lokubhaka

UMaria ubhaka isonka.



Isonka singena eovenini.



Isonka siyaphuma eovenini.



Isonka sibhaka iiyure ezi _____.



Umngeni

Ndiyakwazi ukubona ipatheni.



Kwixesha eliphindwe kabini

a. Tshintsha iiyure zibe yimizuzu.

Iiyure	1	2	4	8
Imizuzu	60			

b. UJabu uthatha imizuzu engama-45 ukuya esikolweni.

UTumi uliphinda kabini eli xesha. Zingaphi iiyure ezithathwa nguTumi ukuya esikolweni?

Teacher: _____
 Sign: _____
 Date: _____

Ukulinganisa ubude



Amacala alo nxantathau ewonke anobude obuziipenisile ezi-3.

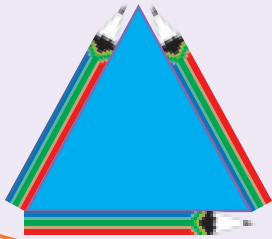

Amacala ezi zikwere ewonke anobude obuziipenisile ezi-4.

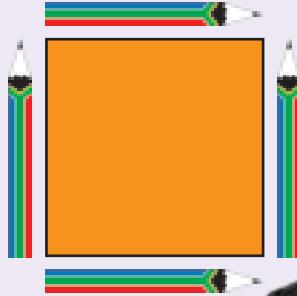

Azi ukuba olu xande lude kwaye lubanzi kangakanani na?



Lude kangangeepenisile ezingaphi olu xande?

Lubanzi kangangeepenisile ezingaphi uxande?

ubude

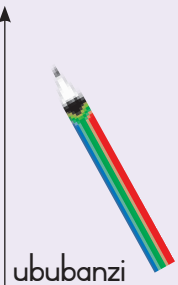

Uzisebenzise njani iipenisile ekubaleni kwakho?



Ubude obuyimfihlo

a. Kufuneka ube nemigca **ebomvu** emingaphi ukuze ukwazi ukugquma umgca omnyama?



b. Kufuneka ube nemigca **ebomvu** emingaphi ukuze ukwazi ukulujikeleza lonke olu xande?

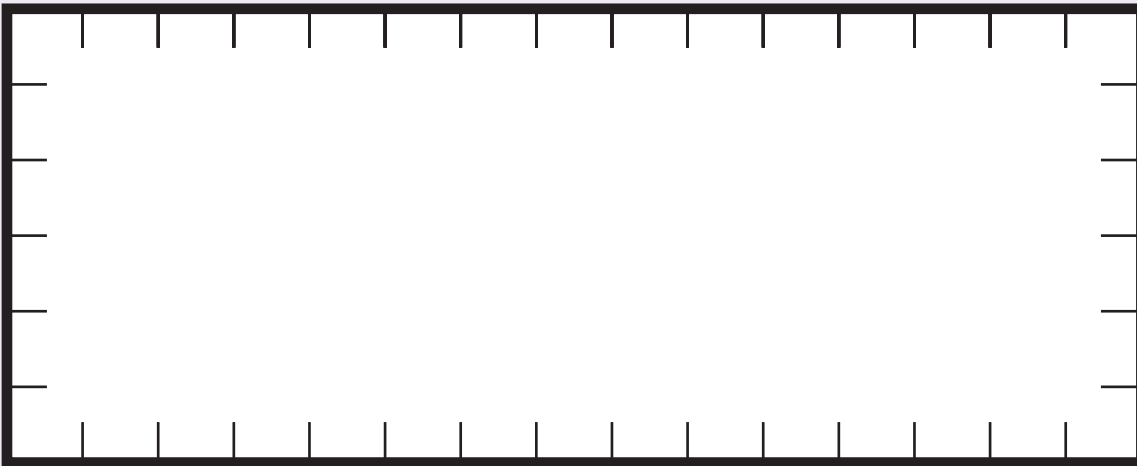

c. Yeyiphi ende, yindlela engentla okanye yindlela engezantsi okanye ziyafana?

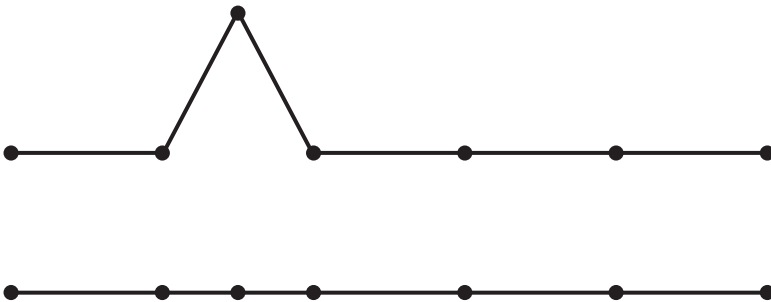

Impendulo _____

Kutheni? _____



Teacher: _____
 Sign: _____
 Date: _____



Umthamo

Ijagi ithatha iikomityi ezili-10 zamanzi. Sendigalele iikomityi ezimbini ejagini.

Ziikomityi ezingaphi zamanzi ezisafunekayo ukuzalisa isikhongozelo?



Zingaphi iikomityi zamanzi ezikwisikhongozelo?

Zingaphi iikomityi ezisafunekayo ukuzalisa isikhongozelo?

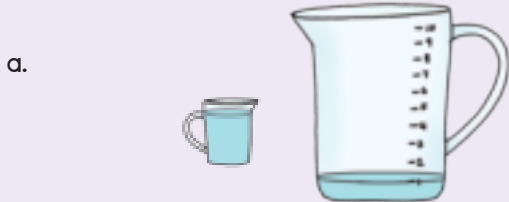

Kwisikhongozelo:

Kufuneka:



Kwisikhongozelo:

Kufuneka:



Kwisikhongozelo:

Kufuneka:



Kwisikhongozelo:

Kufuneka:



Kwisikhongozelo:

Kufuneka:



Kwisikhongozelo:

Kufuneka:

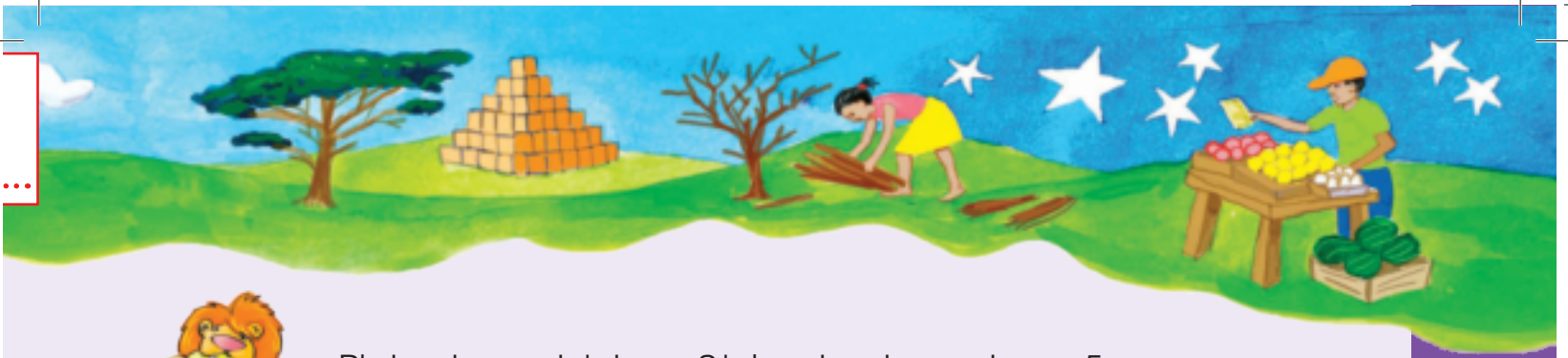

Bhala imilinganiselo kule jagi. Sikubonisile umlinganiselo wesi -5.
Fakela eminye imilinganiselo ejagini.

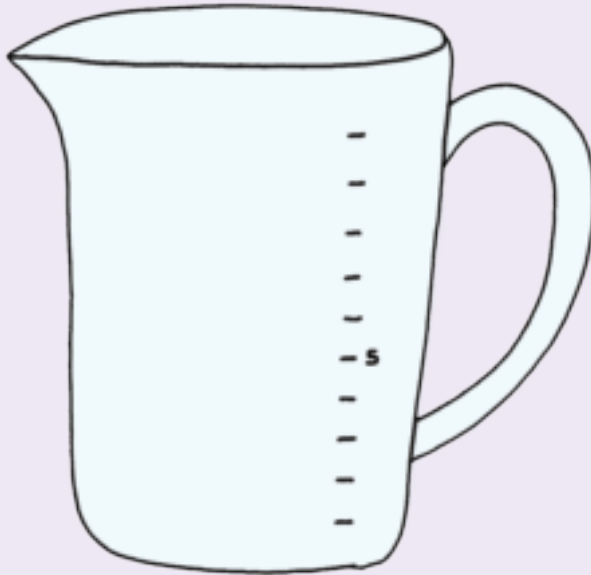

Ukuba ikomityi enye ilingana umlinganiselo omnye wejagi, zingaphi iikomityi ezifunekayo ukuze zifikelele kulo mlinganiselo:

- a. 4 _____
- b. 6 _____
- c. 8 _____
- d. 10 _____



Phawula izikhongozelo ocinga ukuba zingathatha ulwelo olulingana ilitha e-1.

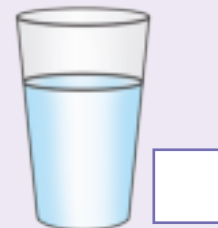

Teacher: _____
Sign: _____
Date: _____

Ukusebenza ngobunzima (imasi)



Masilinganise ubunzima bethu!

Ukuze sifumane ubunzima bethu, ukuba sisinda okanye sikhaphu-khaphu kangakanani sisebenzisa isikali.

Ubunzima sibulinganisa **ngeekhilogramu**. Sisebenzisa esi sifinyezo: kg. Ngubani oyena unzima kakhulu?

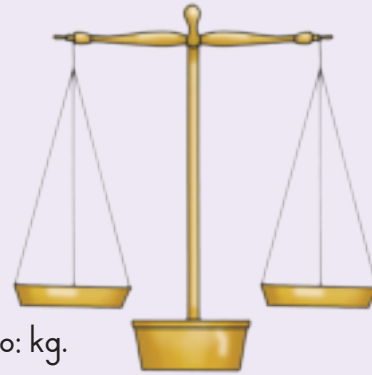

41 kg



38 kg



41 kg



42 kg



39 kg



Sisebenzisa isikali ukuze sikwazi ukulinganisa ubunzima.



Ama-apile akwesi sikali anobunzima obulinganayo.

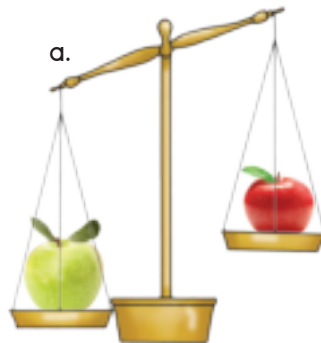

Phendula umbuzo, ubhale a okanye b.

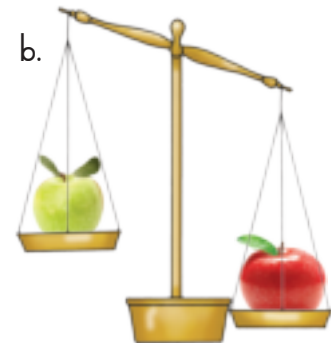

Kukwesiphi isikali apho iapile eliluhlaza linzima kuneapile elibomvu?

Kukwesiphi isikali apho iapile eliluhlaza likhaphukhaphu kuneapile elibomvu?



Linganisa izikali.

Sikwenzele eyokuqala.

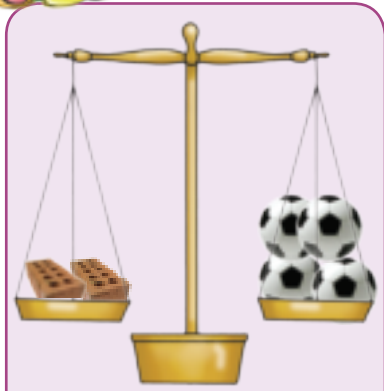

Iziten ezibini zinobunzima obulingana nobeebhola ezine.

Zoba ubonise ukuba ungafuna izitena okanye iibhola ezingaphi ukuze wenze esi sikali silingane macala.

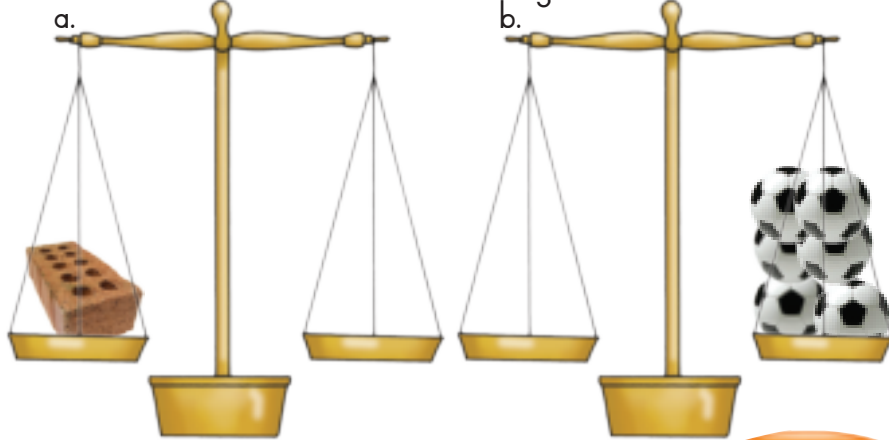

Ukuba ipasile enye inobunzima obuzii-3 kg, ziya kuba nobunzima doungakanani ezi ____?

- Iipasile ezi-2 _____ kg
- Iipasile ezi-3 _____ kg
- Ndingakwazi na ukulinganisa iipasile ezi-4 ngaxeshanye kwesi sikali sasekhithshini? _____
Ngoba kutheni? _____



Phawula iibhokisi zeempendulo ezinezinto ezinobunzima obuyi-1 kg.

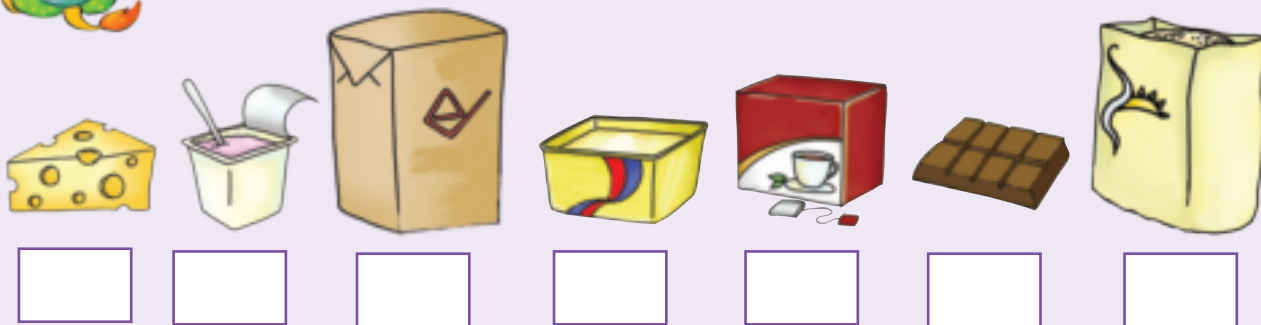

Teacher: _____
Sign: _____
Date: _____



Ukusebenza ngeenkukacha

Izihlangu eklasini.

Funda ibali.

Thabo: Yhoo, Titshalakazi! uJack sisigebenga! Unxiba u-6 esihlangwini!



Nksk. Khoza: Kunjalo Thabo, yisayizi enkulu leyo ukuba inganxitywa ngumntwana oneminyaka eli-9 ubudala!
Unxiba eyiphi isayizi wena, Thabo? Banxiba eziphi isayizi abanye apha eklasini?
Masenze ubalo!

Abafundi bakhwaza iisayizi zezihlangu zabo ngabanye-ngabanye.

UNksk. Khoza ubhala iisayizi zezihlangu ebhodini.

Nksk. Khoza: Balani, nandule ukubhala inani lesayizi nganye ekwitheyibhile.

2	2	3	1	2	3	1	4	3	2	3
2	3	2	6	2	2	3	3	3	4	3
4	2	2	3	3	5	3	2	2	2	1
1	1	2	4	2	3	2	3	4	2	4
4	3	2	2	3	1	2	2	1	4	3

Gcwalisa le theyibhile.

Iisayizi zezihlangu eklasini.					
Usayizi 1	Usayizi 2	Usayizi 3	Usayizi 4	Usayizi 5	Usayizi 6



Yenza umfanekiso wegrafu.



= umfundi omnye

Usayizi 1	Usayizi 2	Usayizi 3	Usayizi 4	Usayizi 5	Usayizi 6



Phendula ngoku le mibuzo.

- Uninzi lwabafundi lunxiba usayizi _____ wezihlangu.
- Elona limbalwa inani linxiba usayizi _____.
- Ba _____ abantwana abathathe inxaxheba kubalo.



Wena?

Fumanisa ukuba ninxiba eziphi iisayizi zezihlangu wena nabahlobo bakho!

- Sebenzisana neqela labantwana aba-6 ukuya kwabasi-8.
- Qokelela iinkcukacha.
- Bhala inani leesayizi zezihlangu phakathi kwitheyibhile.
- Thelekisa iimpendulo kunye namanye amaqela.



Teacher: _____
 Sign: _____
 Date: _____

Thelekisa uze ulandelelanise amanani

Ikota yoku-1

75	76	77	78	79	80	81	82	83	84	85	86	87	88	89	90	91	92	93	94	95	96	97	98	99
----	----	----	----	----	----	----	----	----	----	----	----	----	----	----	----	----	----	----	----	----	----	----	----	----

Leliphi inani eliphambi kwama-84? Leliphi inani eliza emva kwama-84?

Leliphi inani eliphakathi kwama-88 nama-90?



Fakela amanani angekhoyo.

51																									
															67										
																									100

Sebenzisa ibhodi yamanani uphendule imibuzo.

- Leliphi inani eliphambi kwama -68? _____
- Leliphi inani eliza emva kwama -68? _____
- Bhala amanani amahlanu anganeno kunama -71 _____, _____, _____, _____, _____
- Bhala amanani amahlanu amakhulu kunama -71 _____, _____, _____, _____, _____
- Ngawaphi amanani aphakathi kwama -79 nama -84? _____
- Bhala amanani uqale kwelona lincinci uye kwelona likhulu. 73, 52, 50, 59, 61

- Bhala amanani uqale kwelona likhulu uye kwelona lincinci. 74, 96, 99, 91, 38

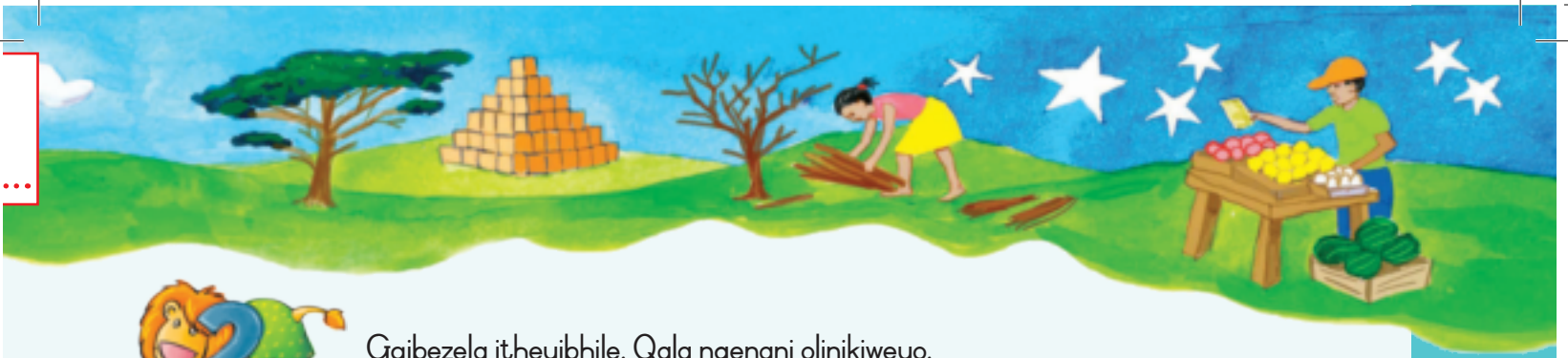

Gqibezela itheyibhile. Qala ngenani olinikiweyo.

	linye ngaphezulu	linye nganeno	lishumi ngaphezulu	lishumi nganeno
25				
39				
74				
56				
40				



Biyela ngesangqa elona nani likhulu.

78 87 17 36 63 33

Biyela ngesangqa elona nani lincinci.

99 19 9 14 41 40



Ukuba olu phawu < luthetha ukuba ncinci, ze olu > luthethe ukuba nkulu, gqibezela:

32 < 64 23 > 18

57 98 89 57



Khangela amanani amahlanu kwiphephandaba aphakathi kwama-50 nama-99 uze uwancamathisele apha.

Teacher: _____

Sign: _____

Date: _____

Ixabiso lendawo ukuya kuma-99



Ukubonisa amanani usebenzisa izinto

Siyakwazi ukubonisa amanani ngeebloko zamaxabiso eendawo.

Ibloko encinci imele u-1. Yiyunithi okanye ngumvo .
Intonga yeebloko ezincinci ezilishumi imele i-10. Lishumi.

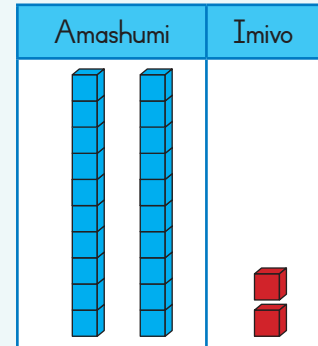

Unokubonisa inani usebenzisa amashumi nemivo.

Nantsi indlela yokubonisa ama-47.

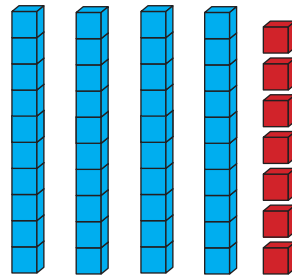

Amashumi	Imivo
4	7

Amashumi amane
anesixhenxe
47



Ukubhala amanani ngokwemivo nangamagama

- Phantsi komfanekiso, bhala ukuba mangaphi amashumi nemivo.
Emva koko bhala inani ngeesimboli namagama.

Amashumi	Imivo	Amashumi	Imivo	Amashumi	Imivo
3	1				
31 amashumi amathathu ananye		_____		_____	

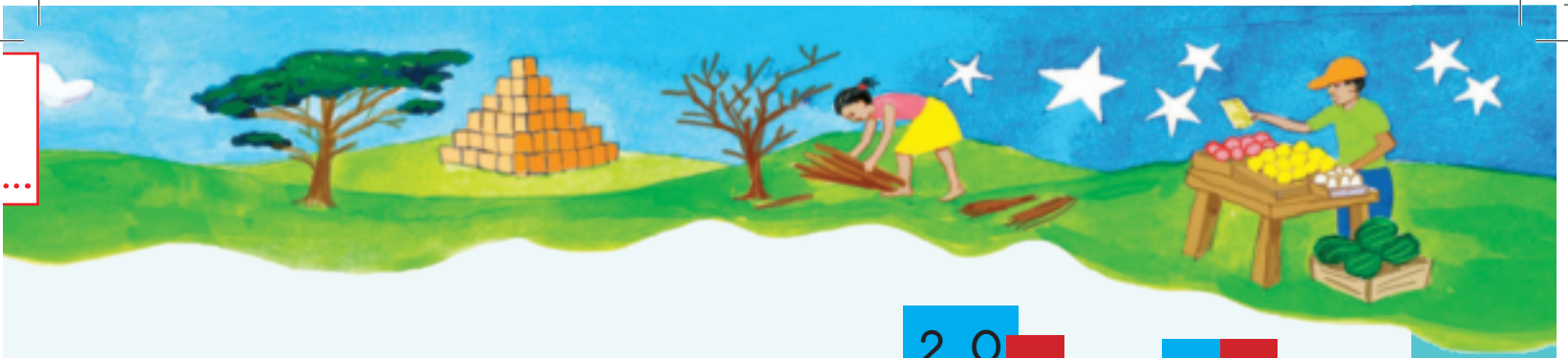

20
6

26

b. Singasebenzisa amakhadi ethu amanani sibonise oku.

Inani	Mangaphi amashumi?	Mingaphi imivo?	Bhala inani ngamazwi
26	2	6	amashumi amabini anesithandathu
46			
99			



Ngubani eli nani?

	<p>30 5</p> <p>35</p>	<table border="1"> <thead> <tr> <th>Amashumi</th> <th>Imivo</th> </tr> </thead> <tbody> <tr> <td>3</td> <td>5</td> </tr> </tbody> </table> <p>amashumi amathathu anesihlanu 35</p>	Amashumi	Imivo	3	5
Amashumi	Imivo					
3	5					
	<div style="border: 1px solid black; width: 40px; height: 20px; margin-bottom: 10px;"></div> <div style="border: 1px solid black; width: 20px; height: 20px; margin-left: 20px;"></div> <div style="border: 1px solid black; width: 40px; height: 20px; margin-top: 10px;"></div> <div style="border: 1px solid black; width: 20px; height: 20px; margin-left: 20px;"></div>	<table border="1"> <thead> <tr> <th>Amashumi</th> <th>Imivo</th> </tr> </thead> <tbody> <tr> <td> </td> <td> </td> </tr> </tbody> </table> <p>_____</p> <p>_____</p>	Amashumi	Imivo		
Amashumi	Imivo					
	<div style="border: 1px solid black; width: 40px; height: 20px; margin-bottom: 10px;"></div> <div style="border: 1px solid black; width: 20px; height: 20px; margin-left: 20px;"></div> <div style="border: 1px solid black; width: 40px; height: 20px; margin-top: 10px;"></div> <div style="border: 1px solid black; width: 20px; height: 20px; margin-left: 20px;"></div>	<table border="1"> <thead> <tr> <th>Amashumi</th> <th>Imivo</th> </tr> </thead> <tbody> <tr> <td> </td> <td> </td> </tr> </tbody> </table> <p>_____</p> <p>_____</p>	Amashumi	Imivo		
Amashumi	Imivo					



Teacher: _____

Sign: _____

Date: _____

Ukubeka amashumi ndawonye xa sidibanisa ukuya kuma-99



Funda

Nantsi indlela yokubonisa ama-22.

Amashumi	Imivo
1 ishumi	12 imivo
1 0	1 0 2

Sineshumi elinye

Sinemivo elishumi elinesibini

Siza kubeka ishumi lemivo eqeleni

Ngoku sinenye indlela yokubonisa ama-22.

Amashumi	Imivo
2 amashumi	2 imivo
2 0	2

Masidibanise $27 + 4$

Siza kuqala ngeebloko ezibhulowu ze songeze ezibomvu.

U-27 ngamashumi amabini nemivo esi-7. Emva koko songeza u-4 ngaphezulu kwimivo.

Amashumi	Imivo
2 amashumi	7 imivo
2 0	7 4

+ 4 imivo

Sinamashumi ama-2 nemivo eli-11.

Sinokubonisa imivo eli-10 njengeshumi elinye.

Amashumi	Imivo
2 0	1 0 1

Ngoku sinamashumi ama-3 nomvo o-1

Amashumi	Imivo
3 0	1

+ =



Bhala izivakalisi senani esiboniswa ngumfanekiso

Amashumi	Imivo	Amashumi	Imivo	Amashumi	Imivo
<input type="text"/>	<input type="text"/> <input type="text"/>	<input type="text"/> <input type="text"/> <input type="text"/>	<input type="text"/> <input type="text"/> <input type="text"/>	<input type="text"/>	<input type="text"/>
$10 + 5 + 6$		___ + ___ + ___		___ + ___ = ___	

Gqibezela umfanekiso. Bhala izivakalisi zamanani eziboniswa ngumfanekiso.

Amashumi	Imivo	Amashumi	Imivo	Amashumi	Imivo
<input type="text"/>		<input type="text"/>		<input type="text"/>	
Amashumi	Imivo	Amashumi	Imivo	Amashumi	Imivo
<input type="text"/>		<input type="text"/>		<input type="text"/>	



Teacher: _____
 Sign: _____
 Date: _____

Bala usebenzise umgca-manani

Hlala edesikeni!

Kwisikolo sethu umfundi ngamnye unedesika yakhe. Kukho abafundi abangama-46 kwiBanga 3A nama-24 kwiBanga 3B. Zingaphi iidesika ezifunekayo kwiiklasi zombini?



Sebenza nogxa wakho

Jonga ukuba aba bafundi bathathu bawusebenzise njani umgca manani ukubala beze nempendulo eyiyo. Ciqibezela isam usebenzise umzekelo ukuncede.

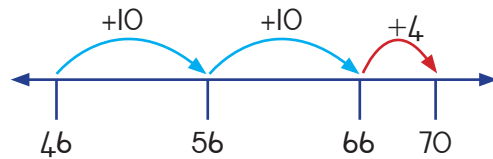

Ndenza ngolu hlobo: Kuqala ndongeza i-10. Oku kundifikisa kuma-56. Emva koko nditsiba elinye i-10 ukuya kufika kuma-66. Okokugqibela, nditsiba isi-4 ngaphezulu ndiyokufika kuma-70.

$$\begin{aligned} &= 46 + 10 + 10 + 4 \\ &= 56 + 10 + 4 \\ &= 66 + 4 \\ &= 70 \end{aligned}$$

Kufuneka ndidibanise ama-24 kuma-46.



a. $32 + 25 =$





b. $52 + 26 =$

c. $46 + 25 =$

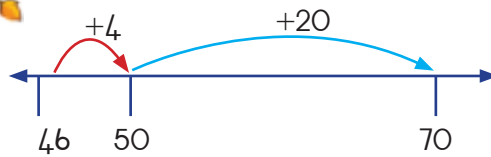

Kufuneka ndidibanise ama-24 kuma-46.



Ndenza oku kuqala: ndiqala nditsibe ka-4. Oku kuya kundibeka kuma-50.
Ndingatsiba ama-20 ngaphezulu ze oko kundibeka kuma-70.

Bonisa ngamakhadi amanani.

$$= 40 + 10 + 20$$

$$= 50 + 20$$

$$= 70$$

a. $36 + 41 =$

Teacher: _____

Sign: _____

Date: _____

Bala usebenzise umgca-manani (kusaqhutywa)

b. $57 + 19 = \square$

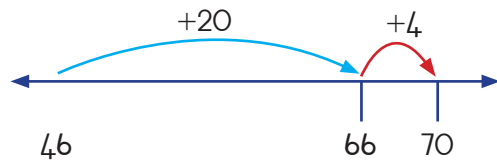

Kufuneka ndidibanise ama-24 kuma 46.



Ndenza oku: Ndisuka kuma-46 nditsibe ama-20. Oko kundibeka kuma-66. Ngoku kufuneka nditsibe imitsi emi-4 ngaphezulu ze ndifike kuma-70.



$$\begin{aligned}
 &= 46 + 20 + 4 \\
 &= 66 + 4 \\
 &= 70
 \end{aligned}$$

a. $63 + 24 = \square$

b. $65 + 29 = \square$

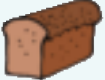

Zingaphi iilofu?

Umbhaki uhambisa iilofu  ezibhrawuni ezingama-54  kunye nezimhlophe ezingama-68.

a. Zingaphi iilofu zesonka zizonke?

b. Fumana isiphumo kumgca-manani. Bonisa amanani kunye nobukhulu bemitsi.

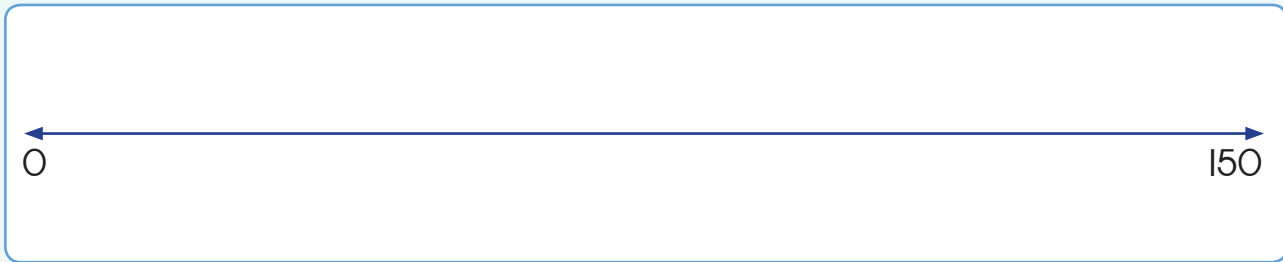

Dibanisa oku kulandelayo ungawusebenzisi umgca-manani.
Sebenzisa nayiphi na indlela oyithandayo.

$$38 + 24 =$$

$$58 + 17 =$$

$$75 + 16 =$$

$$83 + 29 =$$



Teacher: _____

Sign: _____

Date: _____

Thabatha kumgca-manani

Umfundi omnye! Irula enye!

Iklassi ifuna iirula ezingama-53. Kukho ezingama-35.

Kufuneka ezingaphi ukuze ziphelele? $53 - 35 =$

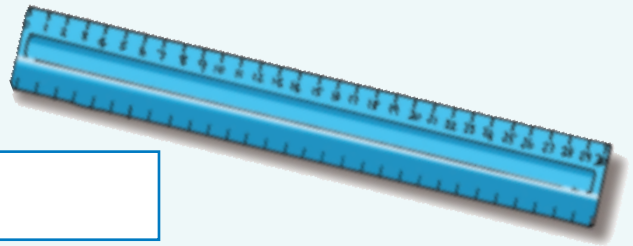

Sebenza nogxa wakho

Funda ukuba ngaba abafundi abathathu bawusebenzisa njani umgca-manani apha. Gqibezela isibalo usebenzise umgca-manani.

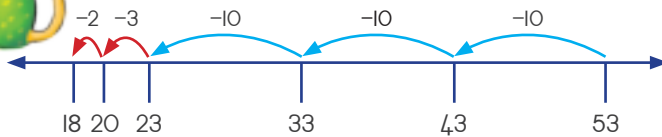

Ndithabathe ama-35 kuma-53. Ukuthabatha kuthetha ukususa into kwenye.



Ngoku, ndiza kuqala kuma-53 ndithabathe. Ndiza kuthabatha i-10, 10, 10 – oko kundibeka kuma-23. Ngoku ukuze ndithabathe isihlanu, kuqala ndithabatha ezi-3, ndifike kuma-20. Ndithabatha ezi-2 ngaphezulu ndize ndifike kwi-18.

Ngoko ke kufuneka iirula ezili-18.

$$= 53 - 10 - 10 - 10 - 3 - 2$$

$$= 43 - 10 - 10 - 3 - 2$$

$$= 33 - 10 - 3 - 2$$

$$= 23 - 3 - 2$$

$$= 20 - 2$$

$$= 18$$



a. $68 - 24 = \square$

b. $74 - 38 = \square$

c. $92 - 87 = \square$

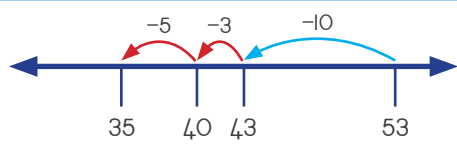

Ukuthabatha kuthetha ukufumana umahluko phakathi kwama-53 nama-35.

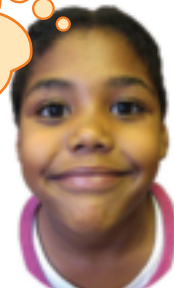

Ndiza kuqala kuma-53 ndibale ndiye kufika kuma-35 ukufumana umahluko. Xa ndibala ndibuya umva nge-10, ndifumana ama-43. Ndinokubala ndiye emva ngokongeza ezi-3 ukuya kuma-40. Emva koko ndibale ukuhla ngokongeza isi-5 ukuya kufika kuma-35. I-10 lidibanise nesi-3 nesihlanu li-18. Ngoko ke kufuneka sifumane iirula ezongezwayo ezili-18.

a. $38 - 14 = \square$



Teacher: _____

Sign: _____

Date: _____

21b

Umhla:

Ikota yoku-1

Thabatha kumgca-manani (kusaqhutywa)

b. $65 - 43 =$

Number line for problem b.

c. $72 - 39 =$

Number line for problem c.

d. $85 - 48 =$

Number line for problem d.

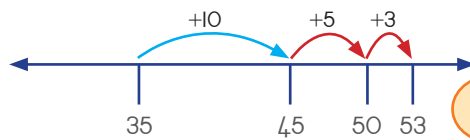

Ndingaqala ngama-35 ndize ndibone ukuba yimitsi emingaphi ukuya kufika kuma-53.



Ndinokuqala ngama-35 ndize ndibone ukuba mingaphi imitsi endiyithathayo ukubala ndiye kufika kuma-53. Ishumi olidibanise nezintlanu kunye nezintathu li-18. Kufuneka kongezwe iirula ezili-18.

a. $84 - 32 =$

Number line for problem a.



b. $96 - 53 = \square$

c. $78 - 19 = \square$

d. $63 - 47 = \square$



Uhambo ngetekisi

Ukuya edolophini ngetekisi ngama-65km.

Okwangoku itekisi ihambe ama-38km.

Kusafuneka ihambe kangakanani?

Sebenzisa umgca-manani ukusombulula le ngxaki.



km



Teacher: _____

Sign: _____

Date: _____

Lixesha lepati





Isicwangciso sokuqala!

UBusi ucela bonke abahlobo bakhe ukuba bafote okona kutya bakuthandayo kwepati. Uqokelele oku. Mncedise akuhlele.

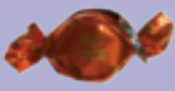

Bala, uze ubhale ukuba bangaphi na abahlobo abakhethe udidi ngalunye lokutya.

				
Inani				

Ukubala uyokufika kuma-200



Bala ama-apile.

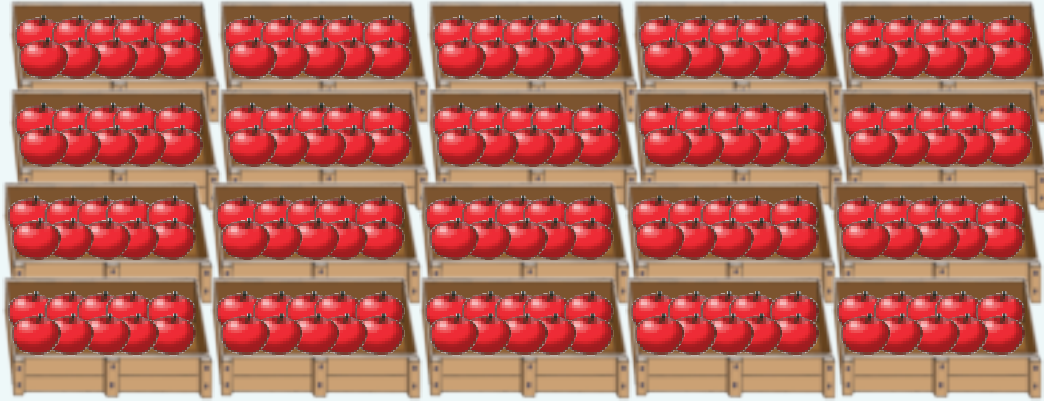

Fakela amanani

Ibhokisi e-1 inama-apile a , umqolo o-1 unama-apile a

Umqolo o-1 uneebhokisi ezi , imiqolo emi-4 inama-apile a



Mangaphi ama-apile esinokuwapakisha kwezi bhokisi?

a. 

b. 

c. 



Bala kumgca-manani.

a. Mangaphi ama-apile aza kuba sezibhokisini ezintlanu?

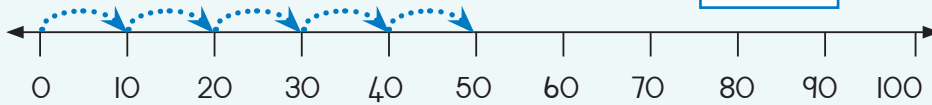

b. Mangaphi ama-apile aza kuba sezibhokisini ezisixhenxe?

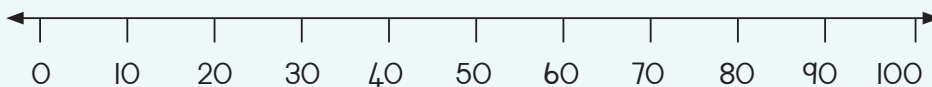



Iziqhuma ezi-3 ze-10 zenza – $3 \times 10 =$ okanye $10 \times 3 =$

iziqhuma ezi-5 ze-10 zenza \times = okanye \times =

iziqhuma ezi-2 ze-10 zenza \times = okanye \times =



Izibini ezi-5 zeenyawo.
Zingaphi iinzwane zizonke?



$10 + 10 + 10 + 10 + 10 =$ $5 \times 10 =$

okanye $10 \times 5 =$

Bala nezi kwangolo hlobo.

Izibini ezi-4 zeenyawo. Zingaphi iinzwane?

= \times = okanye \times =

Izibini ezi-9 zeenyawo. Zingaphi iinzwane?

= \times = okanye \times =



Masibale ngama-10

10, 20, 30, 40, 50, _____, _____, _____, _____,

_____, _____, _____, _____, _____, _____, _____, 200

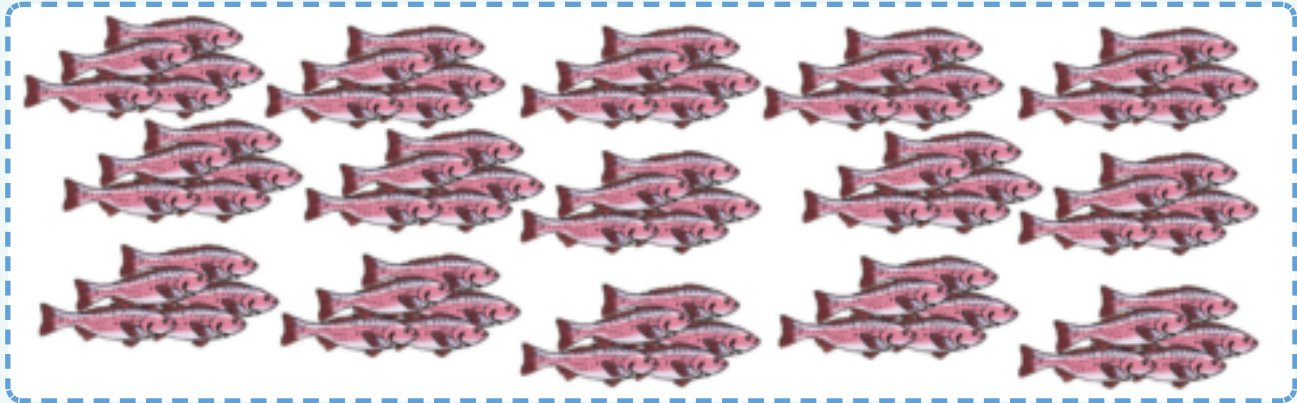

Ziqhelise ngezi-5

Zingaphi iintlanzi? Qikelela Bala ke ngoku iintlanzi. Nika inani lazo zonke. 

Bala ngezi-5

Fumana inani eliphelileyo lamaqanda entlanzi.

Bhala isivakalisi samanani soku-+ noku- \times . Sikwenzele umzekelo wokuqala.

Iintlanzi namaqanda	Mangaphi amaqanda ewonke?	
Iintlanzi ezi-5, inye ibeka amaqanda ama-2	$2 + 2 + 2 + 2 + 2 = 10$	$5 \times 2 = 10$
Iintlanzi ezi-5, inye ibeka amaqanda ali-10		
Iintlanzi ezi-5, inye ibeka amaqanda ama-4		
Iintlanzi ezi-5, inye ibeka amaqanda ama-3		
Iintlanzi ezi-5, inye ibeka amaqanda ama-6		
Iintlanzi ezi-5, inye ibeka amaqanda asi-8		
Iintlanzi ezi-5, inye ibeka amaqanda ama-5		

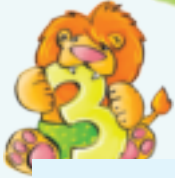

Gqibezela izivakalisi zamanani kunye nemigca-manani

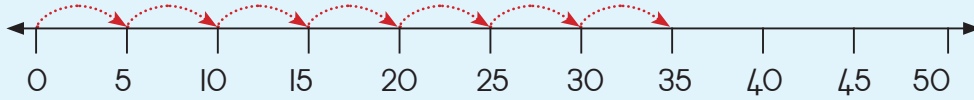

$5 + 5 + 5 + 5 + 5 + 5 + 5 = 35$ okanye $7 \times 5 = 35$

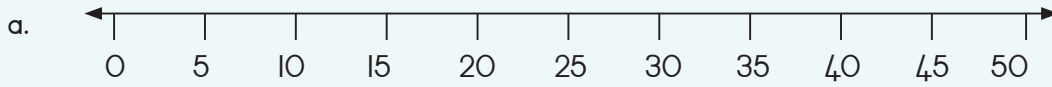

$5 + 5 + 5 + 5 = \square$ okanye $\square \times \square = \square$

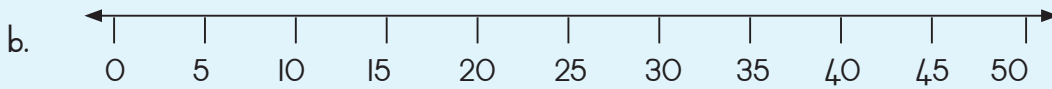

$5 + 5 + 5 + 5 + 5 + 5 + 5 + 5 + 5 = \square$ okanye $\square \times \square = \square$

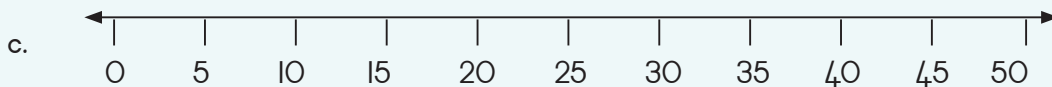

$_ + _ + _ + _ + _ + _ + _ + _ + _ = \square$ okanye $10 \times 5 = 50$



Bamba intlanzi

USipho ubamba iintlanzi eziphakathi kwama-40 nama-50. Uzibala ngezi-2 aze ashiyekelwe yenye. \square Uzibala ngezi-5 aze ashiyekelwe zezi-2. \square

Zingaphi iintlanzi ezibanjwe nguSipho.



25a

Umhla:

Ikota yoku-1

Bala ngezi-2



Bala iikawusi



a. Zingaphi izibini zekawusi? _____

b. Zingaphi iikawusi ezikhoyo? _____

c. Zikhona iikawusi ezishiyekileyo? _____



Masibale izibini zeekawusi

Bhala inani lezibini zeekawusi ezikhoyo, utsho ukuba ingaba zikhona na ezishiyekileyo.

Iikawusi	Inani lezibini	Inani leekawusi	Iikawusi ezingenamati ezishiyekileyo



Teacher: _____

Sign: _____

Date: _____

25b

Umhla:

Ikota yoku-1

Bala ngezi-2 (zisaqhutywa)



Ukwakha izibini

Bhala amanani angoonombini kunye nayiminqakathi ukusuka ku-1 uye kuma-60.

a. Bhala amanani angoonombini ukusuka ku-1 ukuya kuma-60.

2, 4, 6,

b. Bhala amanani ayiminqakathi ukusuka ku-1 ukuya kuma-60

3, 5, 7,



Iminqakathi noonombini

Yenza isangqa kumanani angoonombini.

Yenza isikwere kumanani ayiminqakathi.

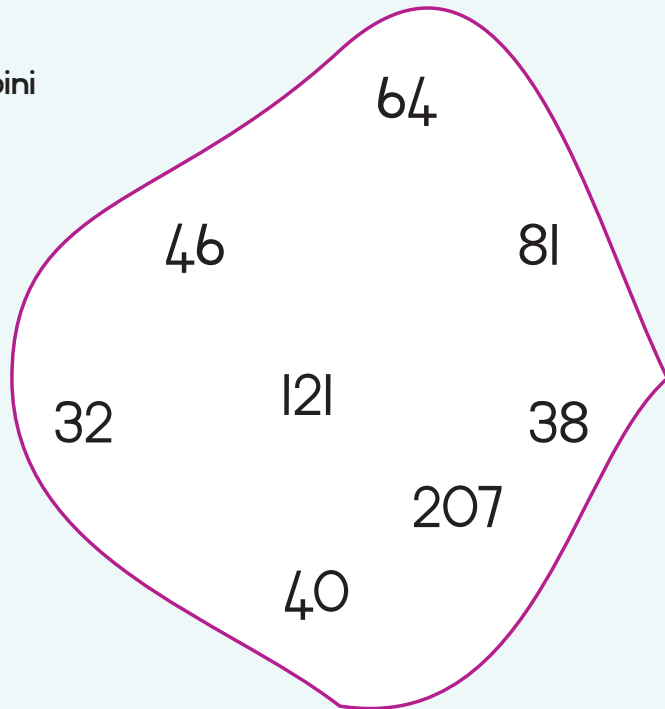

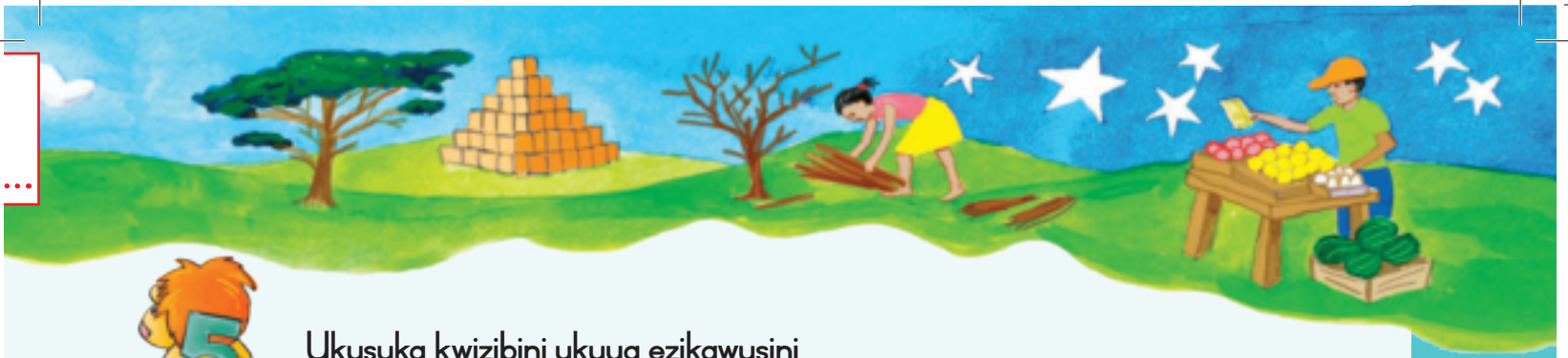

Ukusuka kwizibini ukuya ezikawusini

Umzekelo:

Iikawusi ezi-2 = Isibini esi-1



Iikawusi ezingama-20 = Izibini ezili-10

$$2 \times 1 = 2$$

$$2 \times 10 = 20$$

a. Bhala inani leekawusi.

Cinga ngezi-2	Isivakalisi samanani
Isibini esi-1 = iikawusi ezi-2	$2 \times 1 = 2$
Izibini ezi-2 = iikawusi ezi _____	$2 \times 2 = \square$
Izibini ezi-4 = iikawusi ezi _____	
Izibini ezi-8 = iikawusi ezi _____	
Izibini ezili-9 = iikawusi ezi _____	

b. Bonisa isiphumo kumgca-manani uze ugqibezele.

Umzekelo:

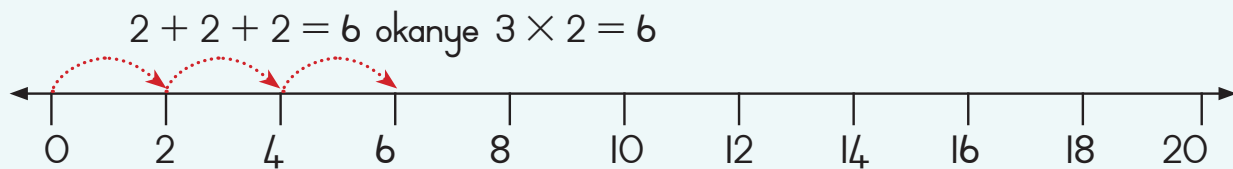

$$2 + 2 + 2 + 2 + 2 + 2 + 2 = \square \text{ okanye } \square \times \square = \square$$

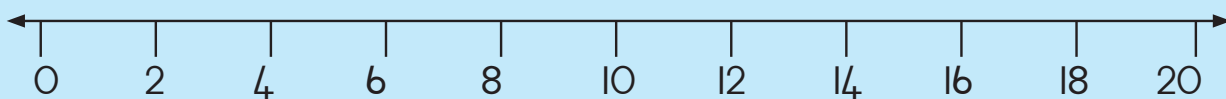

Teacher:

Sign:

Date:

Imali yakudala neyangoku



Ibali lemali yethu

EMzantsi Afrika sisebenzisa iirandi neesenti njengemali yethu. Saqala ukusebenzisa iirandi neesenti ngonyaka ka-1961.

Ngezo ntsuku ingqekembe yesenti enye yayiyeyona incinane, ilandelwa yeyee-2c kwandule ukuza kweyee-5c.



<p>Ndandisebenzisa ezi ngqekembe zincinci ndihlawula izinto ezininzi. Amaxabiso ezinto ayefikeleleka ngoko!</p>	<p>Ewe, unyanisile, azisenziwa!</p> <p>Kodwa makhulu, andizange ndizibone iingqekembe ze-1c ne-2c.</p>
<p>Kwiminyaka engama-50 eyadlulayo sasisebenzisa iiponti, isheleni kunye nepeni.</p>	<p>Ewe, ndiyakhumbula! iponti e-1 yayiziisheleni ezingama-20 yona isheleni e-1 iziipeni ezili-12.</p>

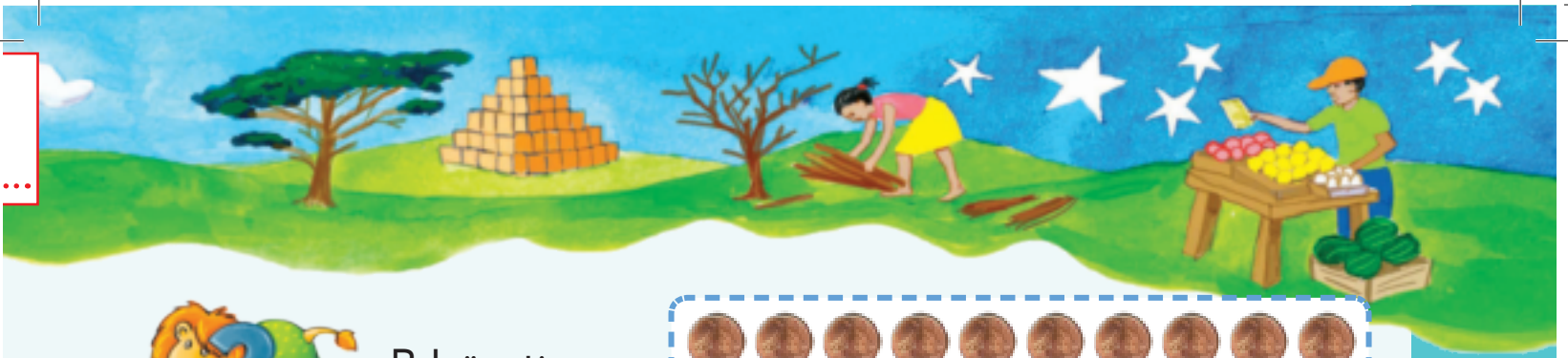

Bala iisenti

Yenza irandi enye.

Zingaphi iisenti ezikhoyo?

Kusafuneka ezingaphi ukuze ukwazi ukwenza i-R1,00?

Zizobe.

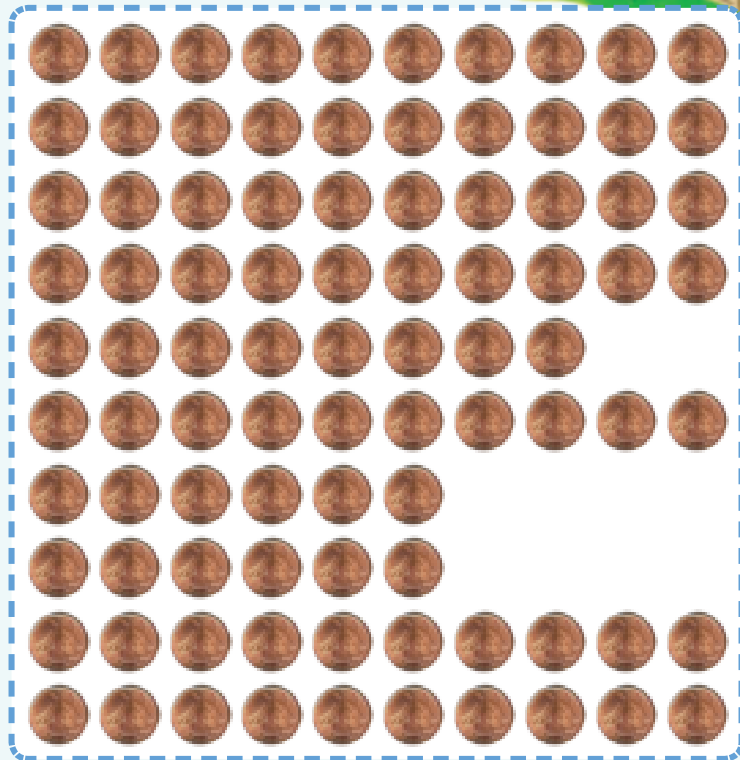

Zingaphi iisenti?

R1,00 = <input type="text"/> c	R2,00 = <input type="text"/> c
R3,00 = <input type="text"/> c	R1,50 = <input type="text"/> c



Ndingathenga iziqhamo ezingakanani?

2  zixabisa i-R4,00.

Zingaphi iibhanana zama-R20,00?

2  axabisa i-R2,00.

Mangaphi ama-apile nge-R9,00?



Teacher: _____
Sign: _____
Date: _____

Bala ngezi-3



Amavili abalwa ngezi-3



Itrayisekile enye inamavili ama_____.



Itrayisekile ezi-5 zinamavili ali _____.

$$3 + 3 + 3 + 3 + 3 = 5 \times 3 = \underline{\hspace{2cm}}$$

Itrayisekile ezi-2 zinamavili ama _____.

$$3 + 3 = 2 \times 3 = \underline{\hspace{2cm}}$$

Itrayisekile ezi-4 zinamavili ali _____.

Itrayisekile ezi-6 zinamavili ali _____.

Itrayisekile ezili-9 zinamavili angama _____.

Itrayisekile ezisi-8 zinamavili angama _____.



Imigca-manani

Jonga umzekelo.

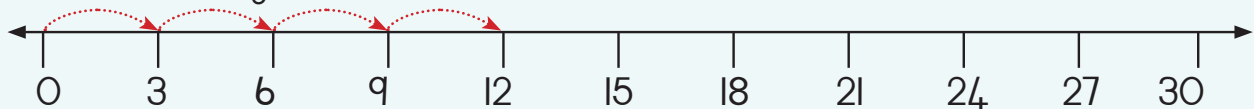

a. $3 + 3 + 3 + 3 = \boxed{\hspace{1cm}} = 4 \times 3 = \boxed{\hspace{1cm}}$

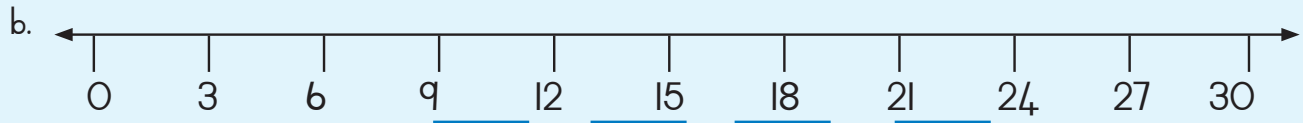

$$3 + 3 + 3 + 3 + 3 = \boxed{} = \boxed{} \times \boxed{} = \boxed{}$$

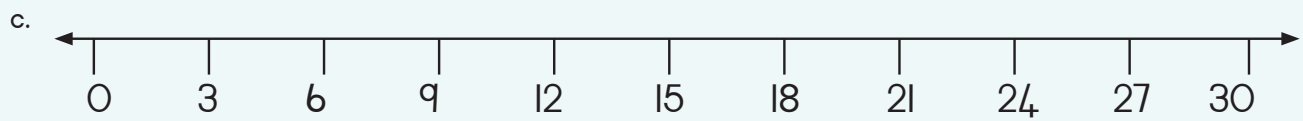

$$\underline{\hspace{10em}} = \boxed{} = 6 \times 3 = \boxed{}$$

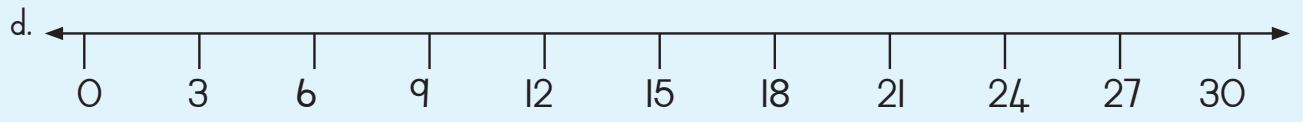

$$\underline{\hspace{10em}} = \boxed{} = 10 \times 3 = \boxed{}$$



Iibhayisekile kunye neetrayisekile



UBusi ubala amavili eebhayisekile naweetrayisekile evenkileni yazo:

Ewonke la mavili ali-14.

Zingaphi iibhayisekile ezikhoyo? _____

Zingaphi iitrayisekile ezikhoyo? _____



Teacher: _____
Sign: _____
Date: _____

Ziintoni izinto ezinezi-4?



Imilenze emine

Amanani aphindaphindwe
ngezi-4 ...
 $4 + 4 = 8$; $2 \times 4 = 8$



Iinkomo zinemilenze emine.











Zeziphi ezinye izinto eziza zinenani elingu-4? _____



Bala imilenze

Ncokolani ngeempendulo.
Cacisa ukuba wenze ntoni.

Sebenzisa iinyaniso ozaziyo ngezi-4 uphendule le mibuzo.

inkomo e-1  <input type="text" value="4"/> imilenze	iinkomo ezi-2  <input type="text" value="8"/> imilenze
iinkomo ezi-3  <input type="text"/> imilenze	iinkomo ezi-4  <input type="text"/> imilenze
iinkomo ezi-5  <input type="text"/> imilenze	iinkomo ezi-6  <input type="text"/> imilenze
iinkomo ezi-7  <input type="text"/> imilenze	iinkomo ezisi-8  <input type="text"/> imilenze
iinkomo ezili-9  <input type="text"/> imilenze	iinkomo ezili-10  <input type="text"/> imilenze

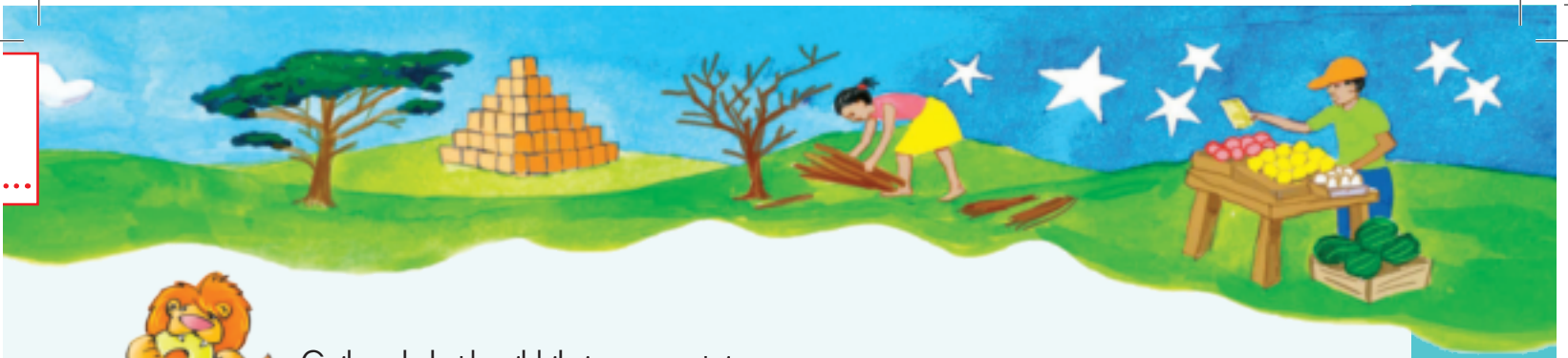

Gqibezela le theyibhile ingasezantsi.
Sebenzisa umzekelo owunikiweyo ukuncede.

Iinkomo ezi-3 zinemilenze e _____	$4 + 4 + 4 = 3 \times 4 = \underline{12}$
Iinkomo ezi-5 zinemilenze e _____	
Iinkomo ezi-4 zinemilenze e _____	
Iinkomo ezisi-7 zinemilenze e _____	
Iinkomo ezisi-8 zinemilenze e _____	



Imigca-manani

Bonisa isibalo sophinda-phindo kumgca-manani uze uwugqibezele ngokusebenzisa imitsi.

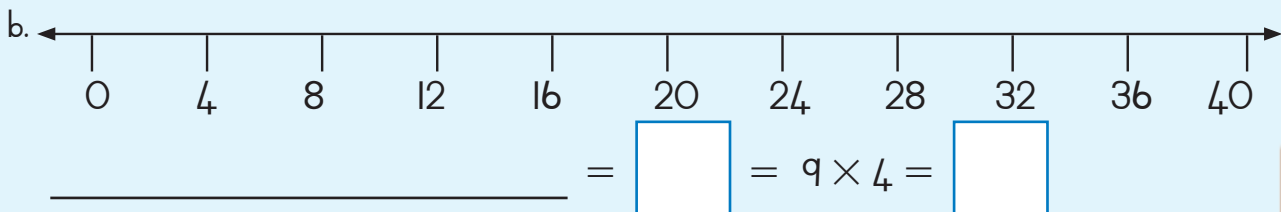
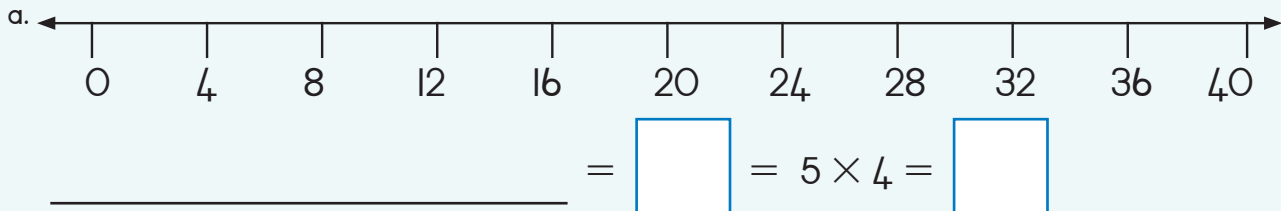

Teacher: _____
Sign: _____
Date: _____



Zenzele ezakho iipatheni

a. Kule patheni yamanani onke amanani angoonombini. Amanye amanani ayintoni? Wabhale phantsi.

□ □ □ □ 74 □ □ □ □

b. Kule patheni yamanani onke amanani ayiminqakathi. Amanye amanani ayintoni? Wabhale phantsi.

□ □ □ □ 65 □ □ □ □



Zingena phi?

48 32 12 36 40 84 45
90 80 15 24 72 150 75

Ipatheni yezi-3 nezi-4	Ipatheni yezi-3 nezi-5	Ipatheni yezi-4 nezi-5
umzekelo 48		



Elwandle

UThembi uqokelela amagobhoza oonokrewece aphakathi kwama-60 nama-70. Xa ewabala ngezi-3, kushiyeke elinye. Isenokuba ngala manani: 61, _____, _____, 70, Xa ebalala ngezi-5 kushiyeke ama-4. Isenokuba ngala manani: _____, _____. Bangaphi oonokrewece anabo uThembi? _____.



○
□
△
Teacher:
Sign:
Date:

30a

Umhla:

Ikota yoku-1

Ukwahlula



Yaba iilekese:

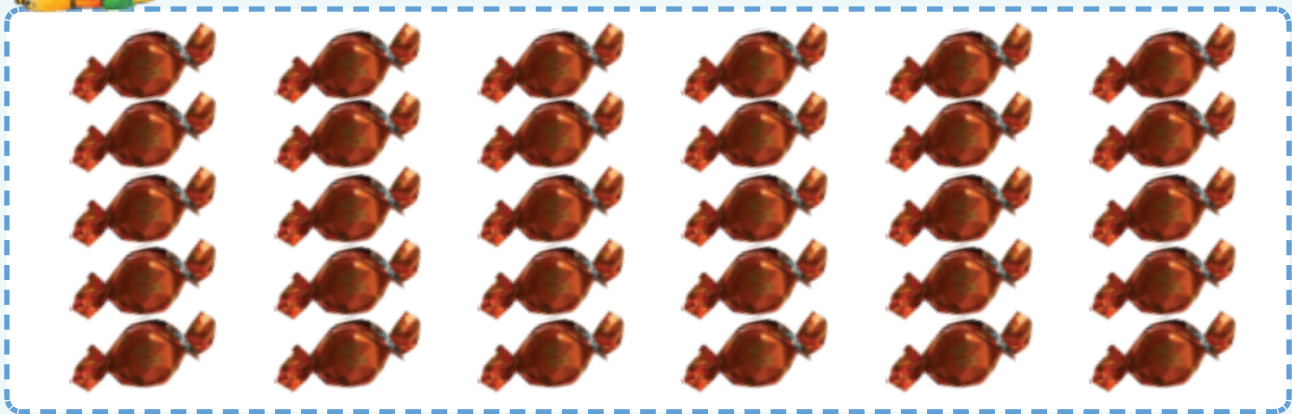

a. Yabela abantwana aba-2 iilekese ezingama-30.



Oku singakubhala ngolu hlobo:

$$30 \div 2 = 15$$

b. Yaba ezi lekese phakathi kwabantwana aba-3.

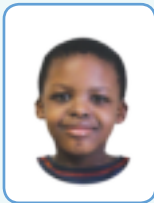

$$\div =$$

c. Yahlulela abantwana aba-5 iilekese

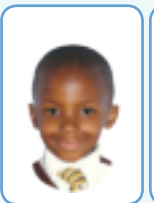

$$\div =$$



Singasebenzisa iibloko zamanani ukuze sikwazi ukwahlula.

$2 \quad 8 \div 2 = 1 \quad 4$	

Ngoku yenza oku.

a.

$\square \quad \square \div 3 = \square \quad \square$	

b.

$\square \quad \square \div 4 = \square \quad \square$	



Teacher: _____

Sign: _____

Date: _____

Ukwahlula (kusaqhutywa)



Sebenzisa imigca-manani ubhale isivakalisi-manani sokuthabatha nokwahlula.

Umzekelo:

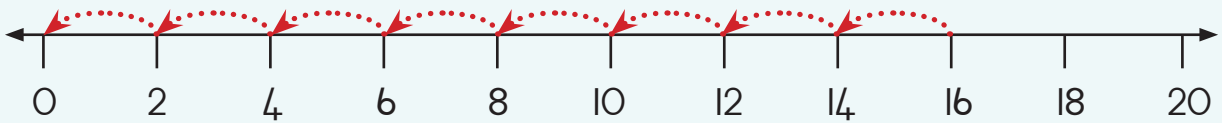

$$16 - 2 - 2 - 2 - 2 - 2 - 2 - 2 - 2 - 2 = 0$$

$$16 \div 2 = 8$$

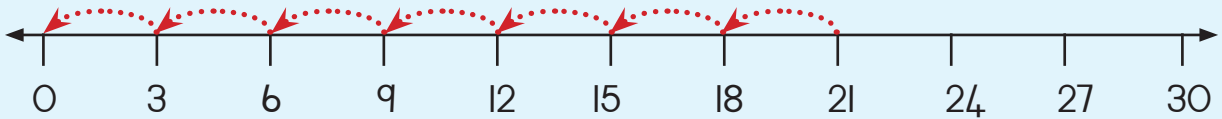

$$21 - \underline{\hspace{2cm}} = \underline{\hspace{2cm}}$$

$$\boxed{\hspace{1cm}} \div \boxed{\hspace{1cm}} = \underline{\hspace{1cm}}$$

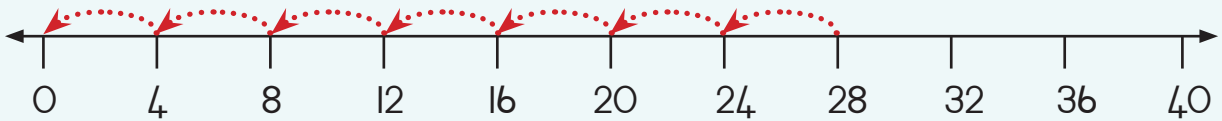

$$28 - \underline{\hspace{2cm}} = \underline{\hspace{2cm}}$$

$$\boxed{\hspace{1cm}} \div \boxed{\hspace{1cm}} = \underline{\hspace{1cm}}$$

c.

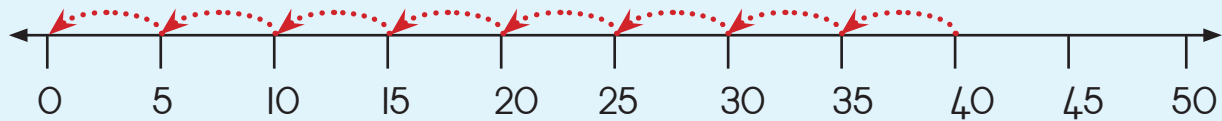

$$\underline{\hspace{1cm}} - \underline{\hspace{2cm}} = \underline{\hspace{2cm}}$$

$$\boxed{\hspace{1cm}} \div \boxed{\hspace{1cm}} = \underline{\hspace{1cm}}$$

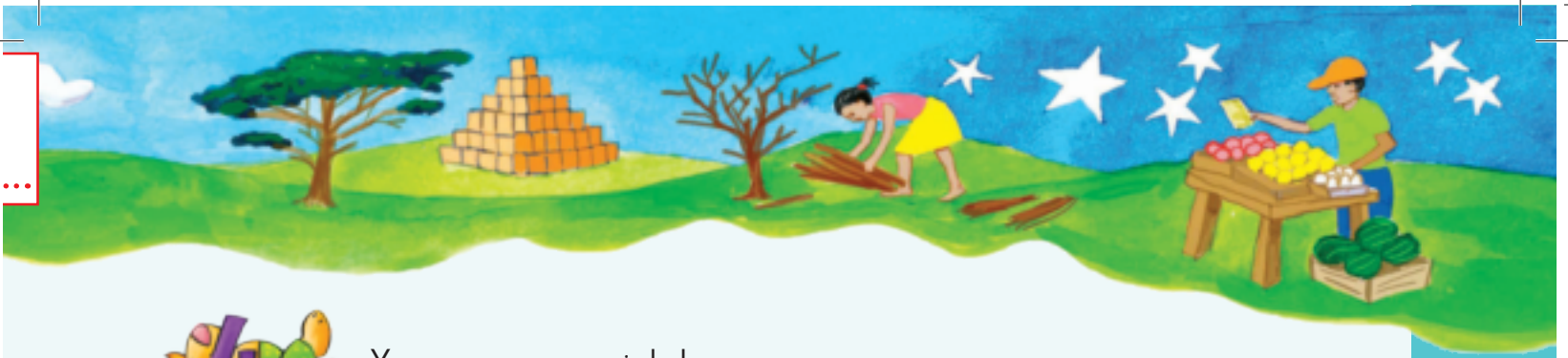

Yenza umgca-manani ubale.

a. $30 \div 5 =$



b. $22 \div 2 =$



c. $27 \div 3 =$



d. $32 \div 4 =$



e. $25 \div 5 =$



Umngeni

Bonisa zonke iindlela onokuzisebenzisa ukwahlula ngokulinganayo iilekese ezingama-24 phakathi kwamaqela ahlukeneyo abantwana.

Bhala isivakalisi samanani ubonise impendulo yakho.

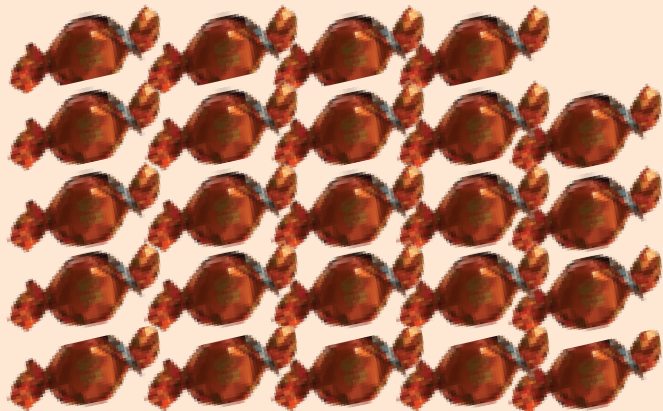

Teacher: _____
 Sign: _____
 Date: _____

Amaqhezu

Ikota yoku-1

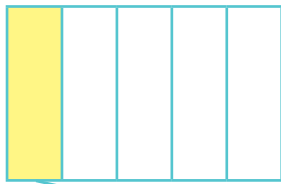

Krwela imigca ukuze utshatise imilo kunye neqhezu:

Isinye
esithathwini

$$\frac{1}{3}$$

Isinye
kwisihlanu

$$\frac{1}{5}$$

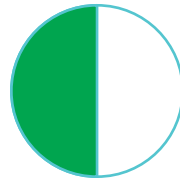

Ikota

$$\frac{1}{4}$$

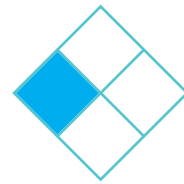

Isiqingatha

$$\frac{1}{2}$$

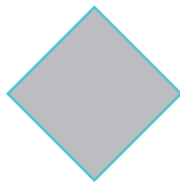

Iikota ezintathu

$$\frac{3}{4}$$

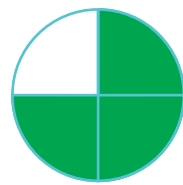
Isine
kwisihlanu

$$\frac{4}{5}$$

Into enye
epheleleyo

$$1$$

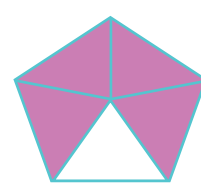
Isibini
kwisithathu

$$\frac{2}{3}$$

Yahlula ze ufake umbala



$$\frac{1}{2}$$

Isiqingatha

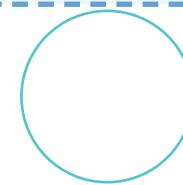

$$\frac{1}{3}$$

Isinye esithathwini

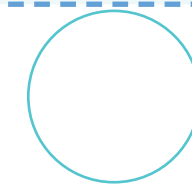

$$\frac{1}{4}$$

Ikota

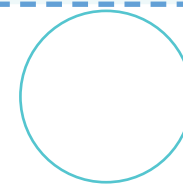

$$\frac{1}{5}$$

Isinye kwisihlanu

Bonisa iqhezu olinikiweyo leelekese:

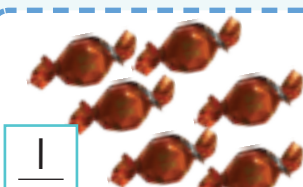

$$\frac{1}{2}$$

Isiqingatha

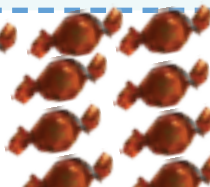

$$\frac{1}{3}$$

Isinye esithathwini

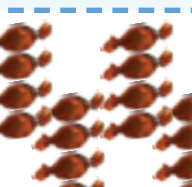

$$\frac{1}{4}$$

Ikota

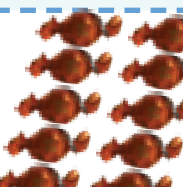

$$\frac{1}{5}$$

Isinye kwisihlanu



Yahlulela abantwana ababini izinto zokubala.

<table border="1" style="width: 100%;"> <tr> <td style="text-align: center;">😊</td> <td style="text-align: center;">😊</td> </tr> <tr> <td style="text-align: center;">●●</td> <td style="text-align: center;">●●</td> </tr> </table>	😊	😊	●●	●●	<table border="1" style="width: 100%;"> <tr> <td style="text-align: center;">😊</td> <td style="text-align: center;">😊</td> </tr> <tr> <td style="text-align: center;">●●●</td> <td style="text-align: center;">●●●</td> </tr> </table>	😊	😊	●●●	●●●	<table border="1" style="width: 100%;"> <tr> <td style="text-align: center;">😊</td> <td style="text-align: center;">😊</td> </tr> <tr> <td style="text-align: center;">●●●●</td> <td style="text-align: center;">●●●●</td> </tr> </table>	😊	😊	●●●●	●●●●	<table border="1" style="width: 100%;"> <tr> <td style="text-align: center;">😊</td> <td style="text-align: center;">😊</td> </tr> <tr> <td style="text-align: center;">●●●●●</td> <td style="text-align: center;">●●●●●</td> </tr> </table>	😊	😊	●●●●●	●●●●●
😊	😊																		
●●	●●																		
😊	😊																		
●●●	●●●																		
😊	😊																		
●●●●	●●●●																		
😊	😊																		
●●●●●	●●●●●																		
<ul style="list-style-type: none"> Sifumene izibalisi ezi-2 emnye. Isiqingatha sezinto zokubala ezi-4 ngu-2. 	<ul style="list-style-type: none"> Sifumene izibalisi ezi- ___ emnye. ___ sezinto zokubala ___. 	<ul style="list-style-type: none"> Sifumene izibalisi ezi- ___ emnye. ___ sezinto zokubala ___. 	<ul style="list-style-type: none"> Sifumene izibalisi ezi- ___ emnye. ___ sezinto zokubala ___. 																
$4 \div 2 = 2$	$___ \div ___ = ___$	$___ \div ___ = ___$	$___ \div ___ = ___$																



Yahlulela abantwana iilekese.

<table border="1" style="width: 100%;"> <tr> <td style="text-align: center;">😊</td> <td style="text-align: center;">😊</td> <td style="text-align: center;">😊</td> <td style="text-align: center;">😊</td> </tr> <tr> <td style="height: 40px;"></td> <td style="height: 40px;"></td> <td style="height: 40px;"></td> <td style="height: 40px;"></td> </tr> </table>	😊	😊	😊	😊					<table border="1" style="width: 100%;"> <tr> <td style="text-align: center;">😊</td> <td style="text-align: center;">😊</td> <td style="text-align: center;">😊</td> </tr> <tr> <td style="height: 40px;"></td> <td style="height: 40px;"></td> <td style="height: 40px;"></td> </tr> </table>	😊	😊	😊			
😊	😊	😊	😊												
😊	😊	😊													
<ul style="list-style-type: none"> ikota yeelekese iikota ezimbini zeelekese = ___ iikota ezintathu zeelekese = ___ iikota ezine zeelekese = ___ 	<ul style="list-style-type: none"> isithathu seelekese = ___ izithathu ezibini zeelekese = ___ izithathu ezithathu zeelekese = ___ 														



Teacher: _____

Sign: _____

Date: _____

Malunga nexesha



Iwotshi

Sinokubhala ixesha elifanayo ngeendlela ezahlukeneyo.

2:15 umkhono emva kwentsimbi yesibini	5:30 icala emva kwentsimbi yesihlanu	9:45 umkhono phambi kwentsimbi yeshumi

Bhala ixesha ngeendlela ezahlukeneyo.



Ukugoduka

UThemba uthabatha ixesha elingakanani xa egoduka?

imizuzu

iiyure

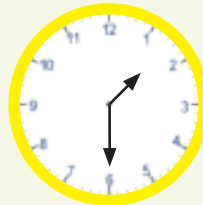

UThemba uyasishiya isikolo.

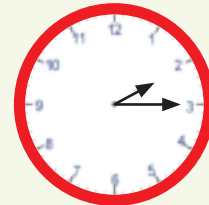

UThemba ufika ekhaya.



Ixesha liyakhawuleza

Ixesha ngezi-2 ...



Mingaphi imizuzu kwiiyure ezi-2? _____

Zingaphi iiyure kwiintsuku ezi-2? _____

Zingaphi iintsuku kwiiveki ezi-2? _____

Zingaphi iinyanga kwiminyaka emi-2? _____



Zingaphi iintsuku?

Ngowama-27 kuEpreli luSuku lweNkululeko.

Ngowe-16 kuJuni luSuku loLutsha.

- Ukusukela ngoSuku lweNkululeko ukuya kuSuku loLutsha zi _____ iinyanga ezipheleleyo, zi _____ iiveki ezipheleleyo ze zibe _____ iintsuku.
- Zingaphi iiveki ezipheleleyo zizonke? _____. Zingaphi iintsuku zizonke? _____. Zingaphi iintsuku ezishiyekileyo? _____.
- Usuku lokuzalwa lukaLebo ziintsuku ezisi-7 phambi koSuku lweNkululeko. Usuku lokuzalwa lukaNtsasa ziintsuku ezimbini emva koSuku loLutsha.

Ngubani omdala? _____

Ngeentsuku ezingaphi? _____

Khangelela. Thelekisa.
Lungisa.

Epreli						
Mv	Lb	Lt	Ln	Lhl	Mga	C
1	2	3	4	5	6	7
8	9	10	11	12	13	14
15	16	17	18	19	20	21
22	23	24	25	26	27	28
29	30					

Meji						
Mv	Lb	Lt	Ln	Lhl	Mga	C
		1	2	3	4	5
6	7	8	9	10	11	12
13	14	15	16	17	18	19
20	21	22	23	24	25	26
27	28	29	30	31		

Juni						
Mv	Lb	Lt	Ln	Lhl	Mga	C
						1
2	3	4	5	6	7	8
9	10	11	12	13	14	15
16	17	18	19	20	21	22
23	24	25	26	27	28	29
30						



Teacher: _____
Sign: _____
Date: _____

Bala ufike kuma-200



Bala amanani

Bala ukhwaze onke amanani asukela kwi-101 ukuya kuma-200.
Khomba njengokuba usiya phambili.



101	102							
111								
121								
131								
							149	
			154					
				165				
		173						180
181					186			
						198		200



Bhala amanani

- Bhala amanani ashiyelelweyo kwisikwere ngasinye esizuba.
- Bhala onke amanani aseleyo.
- Bhala amanani alandelayo ali-10 aza emva kwama-200.

200; _____; _____; _____; _____; _____; _____; _____; _____; _____



Bhala amanani angekhoyo?

a.

200		180			
					110
50					
					0

b.

87		107	
167			
		207	
			237



Gqibezela

200	+	30	+	5	=	235
200	+	40	+	7	=	_____
200	+	60	+	8	=	_____
	+		+		=	293
	+		+		=	256

Bhala amanani ngokulandelelana usuke kwelincinci uye kwelikhulu.



Ukubala ukusuka kwi-100

Bala ukuba kufuneka ntoni ukuze ufikelele kwinani elilandelayo.

Qala

100	→ +25 →	125	→		→	129	→		→	138

Gqiba

168	←		←	157	←		←	151	←		←	145



Teacher: _____

Sign: _____

Date: _____



Ukupakisha amakhandlela

UMaNkosi usebenza kumzi ovelisa amakhandlela.

Xa amakhandlela elungile, uwapakisha ngolu hlobo ezibhokisini aze azibeke kumathala ngamathala.



Mangaphi amakhandlela akwiibhokisi nganye? _____

Zingaphi iibhokisi kwithala ngalinye? _____

Mangaphi amakhandlela akwithala ngalinye? _____



Iibhokisi zamakhandlela

UMaNkosi uvala iibhokisi.

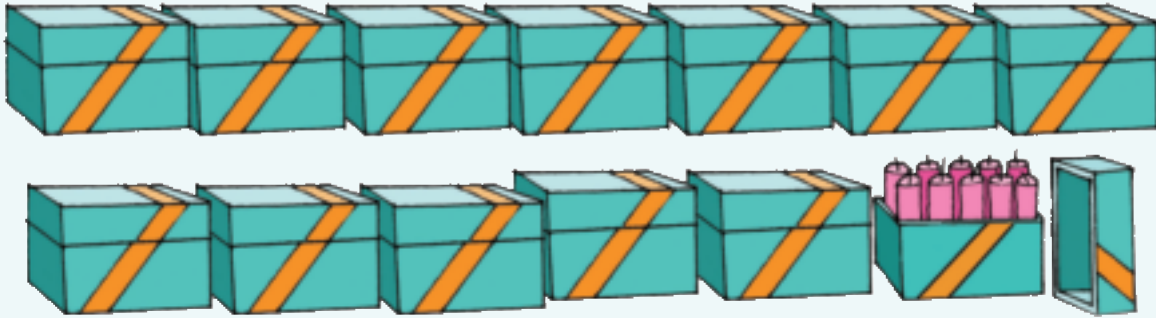







a. Bala zonke iibhokisi.

Zingaphi iibhokisi? _____





Mangaphi amakhandlela ewonke? _____

Kufuneka abe neebhokisi ezingaphi ngaphezulu ukuze abe namakhandlela angama -200? _____

b. Mangaphi amakhandlela kwii -:

bhokisi ezi -2? _____ 	bhokisi ezi -4? _____ 
bhokisi ezi -5? _____ 	bhokisi ezi -3? _____ 
bhokisi ezi -6? _____ 	bhokisi ezisi -7? _____ 

c. Zingaphi iibhokisi ekufuneka enazo:

40  _____ iibhokisi	70  _____ iibhokisi
50  _____ iibhokisi	30  _____ iibhokisi



Teacher: _____

Sign: _____

Date: _____

Ukubeka amashumi ndawonye nokuwacazulula



Ukubeka amashumi ndawonye xa sidibanisa siye kuma-999

<p>Masidibanise $56 + 73 =$</p>		+	
	Amashumi ama-5 nemivo emi-6		Amashumi asi-7 nemivo emi-3

100	10	1
<p>Sisonke sinamashumi ali-12.</p> <p>Sinokudibanisa amashumi ali-10 senze ikhulu eli-1.</p>		

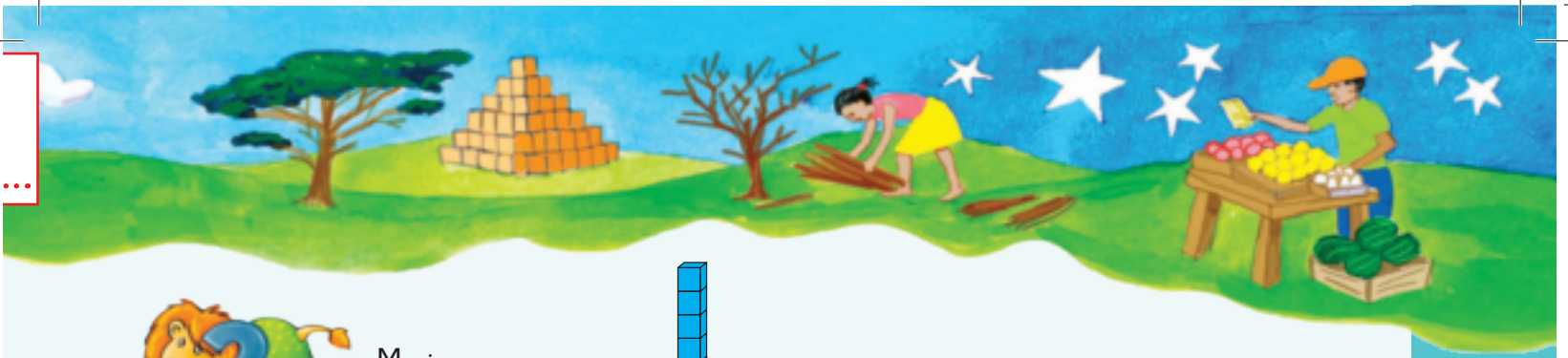

Masizame



= kunye



=



Umzekelo: $82 + 34$

$100 + 20 + 6 = 126$	

a. $65 + 52$

b. $76 + 63$

c. $86 + 65$



Teacher:
Sign:
Date:

Ukubeka amashumi ndawonye nokuwacazulula (kusaqhutywa)



Ukubeka amaqela ndaweninye
Sebenzisa iibloko zamaxabiso endawo.

Sebenzisa iibloko ezilishumi zesiseko ukwenza la manani mabini	Mangaphi amashumi ewonke? Mingaphi imivo?	Udibanise amashumi okanye imivo? Khangela uqaphela ixabiso lendawo apho uhlanganise khona.	Bhala inani
$23 + 99 =$	_____ amashumi _____ imivo	amashumi ali -11 + imivo eli -12 $= 110 + 12$	122
$38 + 25 =$	_____ amashumi _____ imivo		
$77 + 31 =$	_____ amashumi _____ imivo		
$68 + 45 =$	_____ amashumi _____ imivo		
$83 + 47 =$	_____ amashumi _____ imivo		



Ukucazulula amashumi xa sithabatha

Maxa wambi xa sithabatha kufuneka sibonise ishumi elinye njengemivo elishumi, okanye ikhulu njengamashumi ali -10.

Masithabathe: $60 - 55 =$

Siqala ngamashumi amathandathu nemivo engekho. Sifuna ukuthabatha amashumi amahlanu nemivo emihlanu. (imivo esiyithathayo ifakwe umbala ongwevu)

Amashumi amathandathu singawabonisa ngolu hlobo.	Okanye amashumi amahlanu kunye nemivo elishumi.	Thabatha amashumi amahlanu nemivo emihlanu. Kushiyeka imivo emihlanu.
		$60 - 55 = 5$



Masizame

a. $70 - 28$

amashumi asi -7	amashumi ama -6 nemivo eli -10	$70 - 28 =$	

b. $90 - 46$

c. $80 - 53$



Ukufumana isibini samanani

a.

200	
30	

b.

200	
70	

c.

200	
	105

d.

200	
85	



Teacher:
Sign:
Date:

Utyelelo kugqirha wamazinyo



Iqela labantwana lityelela ugqirha wamazinyo.





Uxukuxa kangaphi ngemini?

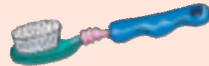

Naku akuxelelwa ngabantwana

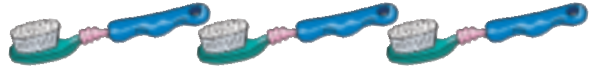

= kanye ngemini

	✓	✓	✓	✓	✓	✓	✓	✓	✓										
	✓	✓	✓	✓	✓	✓	✓	✓	✓	✓	✓	✓	✓	✓	✓	✓	✓	✓	✓
	✓	✓	✓	✓	✓														

a. Bala iimpawu (✓) ubonise ukuba bawahlamba kangaphi abantwana amazinyo abo. Bhala amanani.

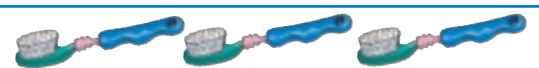
 Kanye ngemini	
 Kabini ngemini	
 Kathathu ngemini	

b. Uqaphela ntoni kule theyibhile?

Uninzi lwabantwana luxukuxa ka _____ ngemini.

Kukho abantwana aba _____ eqeleni.



Zoba igrafu yomfanekiso ebonisa ukuba abantwana baxukuxa kangaphi ngosuku.

 = kanye

Blank area for drawing or writing.



Yenza uphando eklasini yakho. Buza abafundi abali -15 ukuya kuma -20.

- a. Bawahlamba kangaphi amazinyo abo ngosuku? _____
- b. Zoba igrafu efana nale ingentla ubonise iziphumo zakho.



Teacher: _____
 Sign: _____
 Date: _____

Dibanisa uze uqukanise

Ikota yesi-2



Bhala izibalo zakho

UBusi unokudibanisa imivo kunye namashumi aze aqukanise kwakhona. Unokudibanisa aze athabathe abhale ephepheni ngaphandle kokusebenzisa iibloko. Ngamanye amaxesha uthanda ukuqala ngamakhadi akhe amanani ukuze abonise amanani. Ngoko ke kwisibalo $56 + 73$, ufumana la makhadi:

$$\begin{array}{|c|c|c|} \hline 5 & 0 & 6 \\ \hline \end{array} + \begin{array}{|c|c|c|} \hline 7 & 0 & 3 \\ \hline \end{array}$$

Udibanisa imivo aze abeke phantsi ikhadi 9.

Uyazi: $50 + 70 = 120$.

Uthatha ikhadi lamakhulu, elama -20 kunye nele -9.

ukwenza inani elinemivo emi -3.

9

100

20

Uyibhala ngolu hlobo:

$$\begin{aligned} 50 + 70 + 6 + 3 \\ = 50 + 70 + 9 \\ = 120 + 9 \\ = 100 + 20 + 9 \\ = 129 \end{aligned}$$

UDumi uyazi ukuba iibloko zisebenza njani. Isibalo $56 + 73$ usenza ngola hlobo:

$$\begin{array}{r} 50 + 6 + 70 + 3 \\ \swarrow \quad \searrow \\ 120 + 9 \\ = 129 \end{array}$$



UAakar uyakuthanda ukusondeza. Ukwenza ngolu hlobo oku:

$$\begin{aligned} 56 + 73 \\ = 50 + 70 + 10 - 1 \\ = 130 - 1 = 129 \end{aligned}$$





Khawuzizamele ngokwakho. Yenza isibalo ngasinye ngeendlela ezimbini.

a. $86 + 62$

Indlela yokubala kaBusi

$$80 + 60 + 6 + 2$$



Indlela yokubala ka-Dumi

$$80 + 6 + 60 + 2$$



b. $72 + 63$

c. $81 + 57$

d. $69 + 71$

Sebenzisa indlela ka -Aakar xa usenza oku.



Teacher: _____

Sign: _____

Date: _____

Dibanisa uze uqukanise (kusaqhutywa)

Masithabathe.



Indlela yokubala kaBusi

$$80 - 50 + 7 - 3$$

$$= 30 + 4$$

$$= 34$$

Indlela yokubala ka-Dumi

$$80 + 7 - 50 + 3$$

$$= 30 + 4$$

$$= 34$$

b. $95 - 73$
c. $86 - 62$
d. $85 - 69$



Sombulula!

Zininzi iindlela **zokudibanisa** imivo kunye **namashumi**. Khet'ha indlela oyaziyo noyithandayo yokubala ezi zibalo. Bonisa umsebenzi wakho.

- a. UPeter uqala akhe iipesika ezingama -34 aze aphinde akhe ezingama -67. Zingaphi iipesika azikhileyo zizonke?

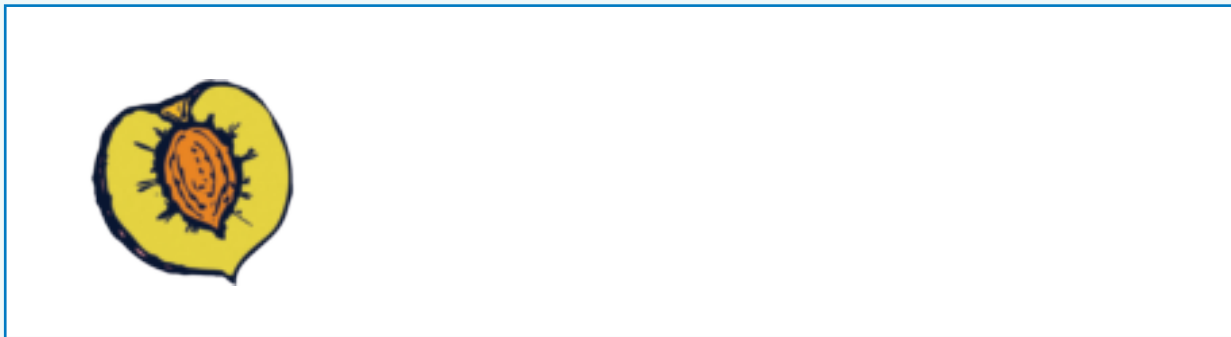

- b. Abantwana bakwaMalusi banemali engama -R47 bebonke. Umama wabo ubaphe ama -R58. Banamali ni ngoku?

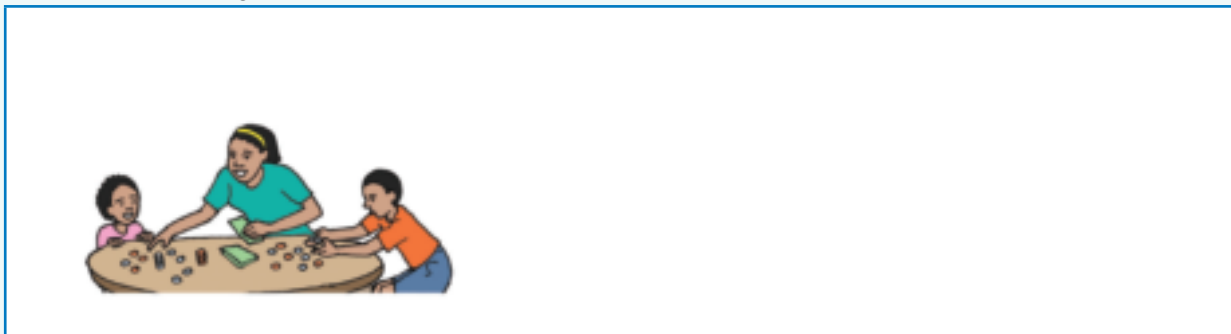

- c. Ibhasi yesikolo ihamba umgama ongama -88 km kusasa nama -73 km emva kwemini. Ihamba umgama ongakanani uwonke?

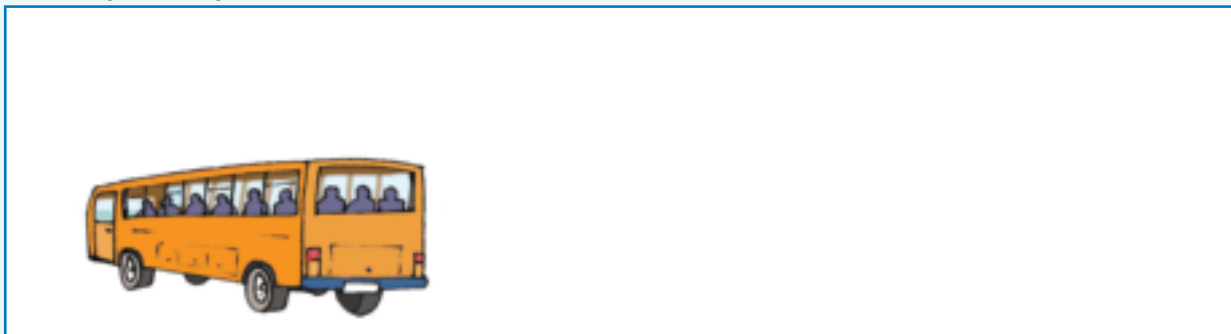

Teacher: _____

Sign: _____

Date: _____

Sombulula!



Iziciko zeebhotile

Sebenzisa nayiphi indlela yokubala oyithandayo.
Bonisa umsebenzi wakho.



USipho



UAndile

USipho ubala iziciko zeebhotile ezingama-87. UAndile ubala ama-38.
Zininzi kangakanani iziciko zebhotile zikaSipho kunezika-Andile?



Umyhadala wekonisathi yesikolo



UMusa



UMusa uthengisa amatikiti. Uqale enamatikiti angama-92. Ushiyekelwe ngamatikiti angama-67 kuphela. Mangaphi amatikiti awathengisileyo ukuza kuthi ga ngoku uMusa?



Ukuziqhelisa ngakumbi



Kukho amantshontsho angama -69 ehokweni nangama -95 kwenye. Mangaphi amantshontsho xa ewonke? Funda ngendlela uGugu no noAakar abasombulula ngayo esi sibalo.

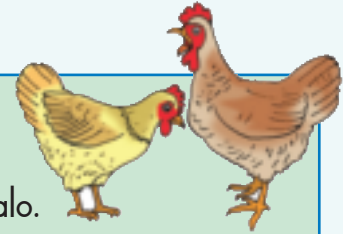

Indlela enza ngayo uGugu
 $60 + 90 + 9 + 5$
 $= 100 + 50 + 14$
 $= 150 + 10 + 4$
 $= 164$



Indlela enza ngayo uAakar
 $69 + 95$
 $= 70 + 95 - 1$
 $= 70 + 90 + 5 - 1$
 $= 160 + 4$
 $= 164$

Ndithabathe u-1. Uyazi ukuba kutheni?



a. Amakhwenkwe aqokelele ama -R96 okulungiselela uhambo lweklasi. Amantombazana aqokelele ama -R79. Iyonke le mali yimalini?

Indlela enza ngayo uGugu

Indlela enza ngayo uAakar

b. Isikolo esinye siqokelele ama -76 kg eetoti. Esinye isikolo siqokelele ama -68 kg eetoti. Ziikhilogram ezingaphi zeetoti zizonke eziqokelelwe zizikolo zozibini?

Indlela enza ngayo uGugu

Indlela enza ngayo uAakar



Bala



Fumana indawo

Bhala amanani ashijiyeyo.

a.	<table border="1"><tr><td>100</td><td></td></tr><tr><td></td><td>27</td></tr></table>	100			27	b.	<table border="1"><tr><td>100</td><td></td></tr><tr><td>39</td><td></td></tr></table>	100		39		c.	<table border="1"><tr><td>100</td><td></td></tr><tr><td>43</td><td></td></tr></table>	100		43		d.	<table border="1"><tr><td>100</td><td></td></tr><tr><td>56</td><td></td></tr></table>	100		56	
100																							
	27																						
100																							
39																							
100																							
43																							
100																							
56																							
e.	<table border="1"><tr><td>200</td><td></td></tr><tr><td>140</td><td></td></tr></table>	200		140		f.	<table border="1"><tr><td>200</td><td></td></tr><tr><td></td><td>110</td></tr></table>	200			110	g.	<table border="1"><tr><td>200</td><td></td></tr><tr><td>135</td><td></td></tr></table>	200		135		h.	<table border="1"><tr><td>200</td><td></td></tr><tr><td></td><td>120</td></tr></table>	200			120
200																							
140																							
200																							
	110																						
200																							
135																							
200																							
	120																						



Ukuthabatha ubuya umva usuka kuma-200 ukuya kwi-100

Thabatha amanani akwibhokisi epinki ngexesha ngalinye. Sikwenzele eyokuqala.

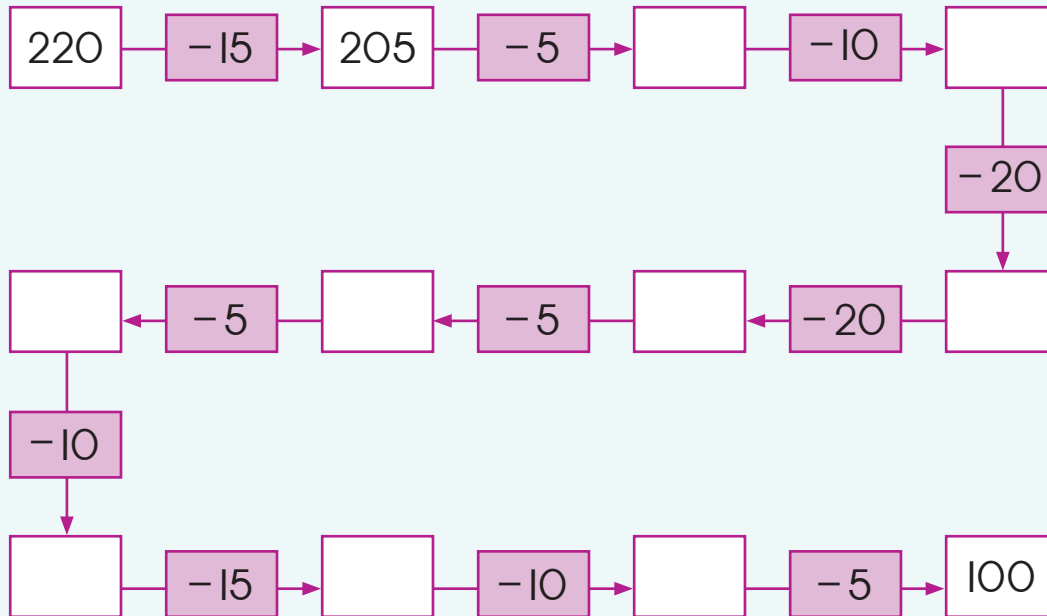

Nantsi indlela yokujonga iimpendulo zakho!
Qala kwi-100! Ubale ubuyele kuma-220.
Ke ngoku dibanisa amanani!



Iintsapho zezithathu

Fumana amanani amathathu othi xa uwadibanisile akunike impendulo ejolise kwinani olinikiweyo. Umthetho: Linani elinye kuphela elinokuphelela ku-0.

Umzekelo:



Ibe ngaphezulu ngama-50, ibe ngaphantsi ngama-50

Bhala iimpendulo kumqolo wesi -2.

+50	70	125	150	81	96	122	134	111	70
	120								
-50	186	200	158	179	139	79	126	138	99
	136								



Teacher: _____
 Sign: _____
 Date: _____

Ukulinganisa ngeesentimitha



Inkulu kangakanani isentimitha?



Amanani akwirula amele **iisentimitha**.

Sisebenzisa isifinyezo okanye isimboli engu **-cm**.

Xa usebenzisa iirula kufuneka uqale ku **-0** xa ulinganisa.

Ezinye iirula azimbonisi u **-0** njengalapha kweli phepha.

Fumana u **-0** cm kwirula. Bhala phezu kwerula.

Uphi u **-10**cm kule rula? Bhala u **-10** apho.



Qikelela wandule ukulinganisa ngokuchanekileyo ngokwee **-cm** ngerula yakho ubude bemigca eyenza imilo nganye.

a.

b.







c.

a. Qikelela <input type="text"/> cm	b. Qikelela <input type="text"/> cm	c. Qikelela <input type="text"/> cm
Linganisa <input type="text"/> cm	Linganisa <input type="text"/> cm	Linganisa <input type="text"/> cm



Mde kangakanani umgca ngamnye?

Ziisentimitha ezingaphi ubude bomgca ngamnye?

a. 	<input type="text"/> cm	d. 	<input type="text"/> cm
b. 	<input type="text"/> cm	e. 	<input type="text"/> cm
c. 	<input type="text"/> cm	f. 	<input type="text"/> cm



Uqinisekile?

Ngowuphi omde, ngumgca obomvu okanye ngumgca oluhlaza?

Ungayijonga njani?

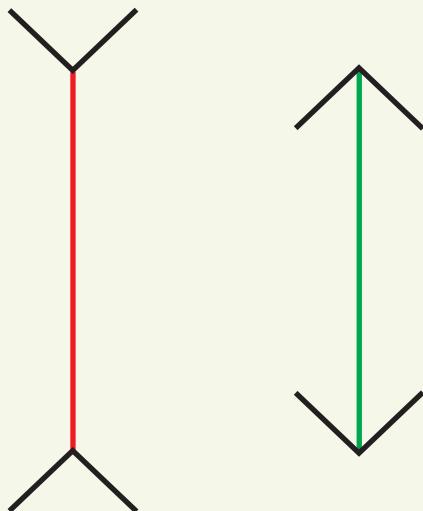

Oku kubizwa ukudideka kwamehlo. Kwenzeka xa amehlo elingwa ngokuboniswa into engekho. Le migca iyalingana ngobude. Imigca emnyama ephumela ngaphandle yenza umgca obomvu ukhangeleke umde ze imigca emnyama ejonge ngaphakathi yenze umgca oluhlaza ukhangeleke umfutshane.



Teacher: _____
 Sign: _____
 Date: _____

Umhla:

41

Bala ufike kuma-300



Bala ubhale ama-200

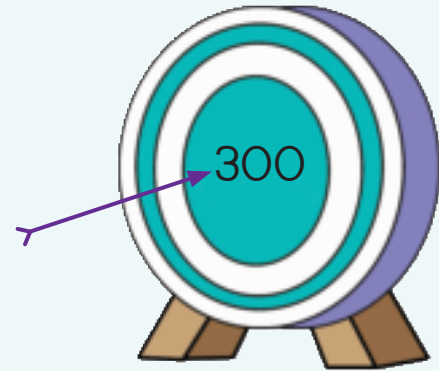

Bala ukusukela kuma -201 ukuya kuma -300.

Khomba njengokuba uhamba.

Zalisa iibloko ezizuba kuqala.

Bhala onke amanye amanani ashiyelelweyo.

201					207			210
211								
221								
231								
							249	
		254						
			265					
	273							280
281				286				
						298		300



Bhala amanani ali -10 aza emva kwama -300.

300; _____; _____; _____; _____; _____; _____; _____; _____; _____

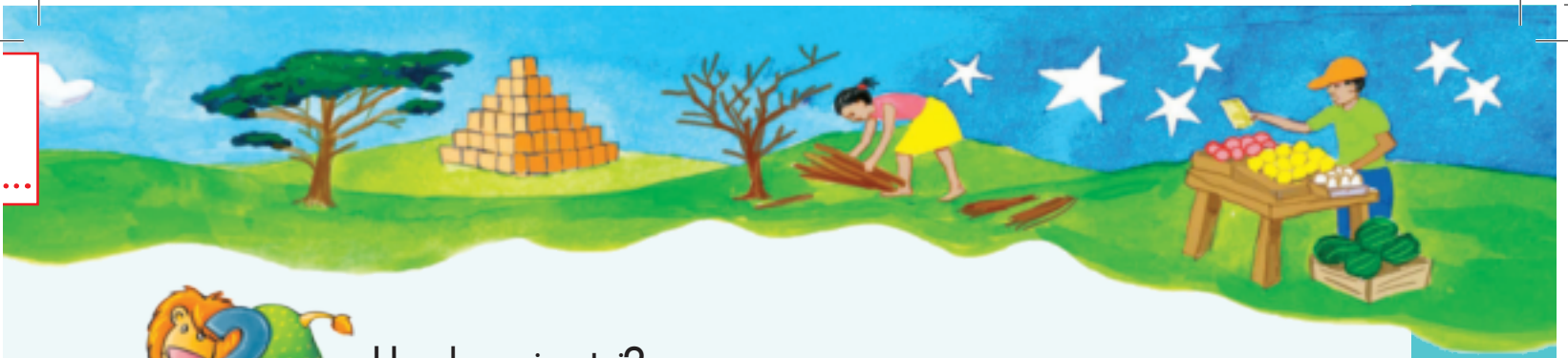

Ungakanani umtsi?

301		281					
		171				211	
					101		



Ukubonisa nokuthelekisa

a. Bhala amanani angena kwikhadi ngalinye.

298; 208; 301; 276; 227; 269; 311

200							
90							
8							

b. Bhala amanani ngokulandelelana kwawo uqale ngelona lincinci ukuya kwelona likhulu.

_____ ; _____ ; _____ ; _____ ; _____ ; _____ ; _____



Yintoni umahluko?

Isiqalo

200	+25	225		237		249

Isiphelo

300		286		278		261



Teacher:
Sign:
Date:

Ukudibanisa nokuthabatha ngama-100



Ukusebenzisa iibloko ukuze udibanise

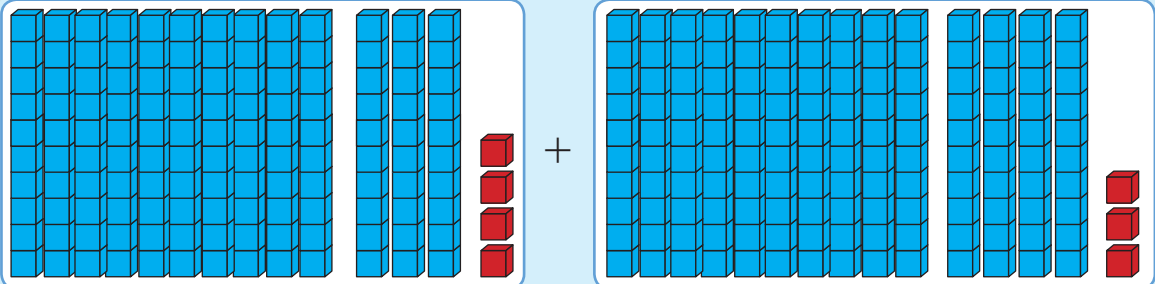

$$\begin{array}{r}
 100 \\
 30 \\
 4 \\
 + \\
 100 \\
 40 \\
 3 \\
 \hline
 200 \\
 70 \\
 7 \\
 \hline
 277
 \end{array}$$



Landela ezi ndlela zimbini. Bonisa impendulo nganye ngeendlela ezimbini.

a. $132 + 123$

Indlela yokubala kaBusi

$$\begin{aligned}
 &= 100 + 100 + 30 + 20 + 2 + 3 \\
 &= 200 + 50 + 5 \\
 &= 255
 \end{aligned}$$



Indlela yokubala ka-Dumi

$$\begin{aligned}
 &132 + 123 \\
 &= 200 + 50 + 5 \\
 &= 255
 \end{aligned}$$



b. $114 + 162$



c. $276 + 148$



Jonga iindlela zokubala uze uthabathe.

a. $158 - 146$

Indlela yokubala kaBusi

$$= 100 - 100 + 50 - 40 + 8 - 6$$

$$= 0 + 10 + 2$$

$$= 12$$



Indlela yokubala ka-Dumi

$$158 - 146$$

$$= 0 + 10 + 2$$

$$= 12$$



b. $194 - 122$

c. $288 - 199$



Teacher: _____

Sign: _____

Date: _____

Bala ufike kuma-400



Ukubala nokubhala ama-400

Bala uqale kuma-300 ukuya kuma-400.

Wabize amanani njengokuba usiya phambili.

Bhala amanani angekhoyo kwigridi.

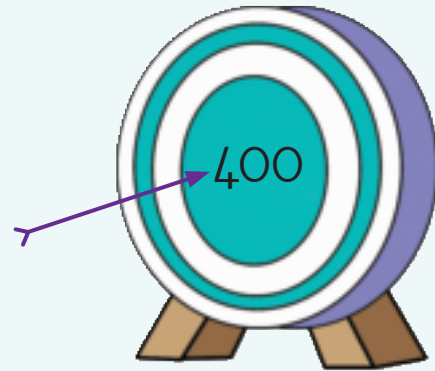

301									310
			315						
									330
331			335						
								249	
			365			368			
	273								
									390
									400

Bhala amanani ali-9 alandela ama-400.

400; _____; _____; _____; _____; _____; _____; _____; _____; _____;



Bala uye phambili okanye ubuye umva

a. Bala uye phambili uqale kuma -300.

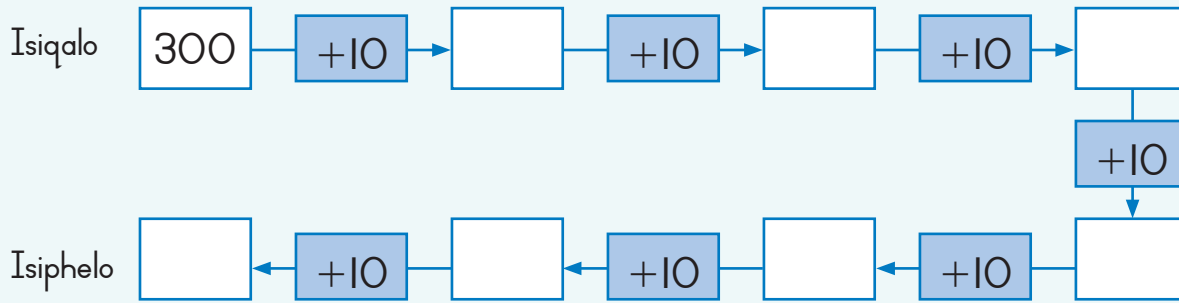

b. Bala uqale kuma -400

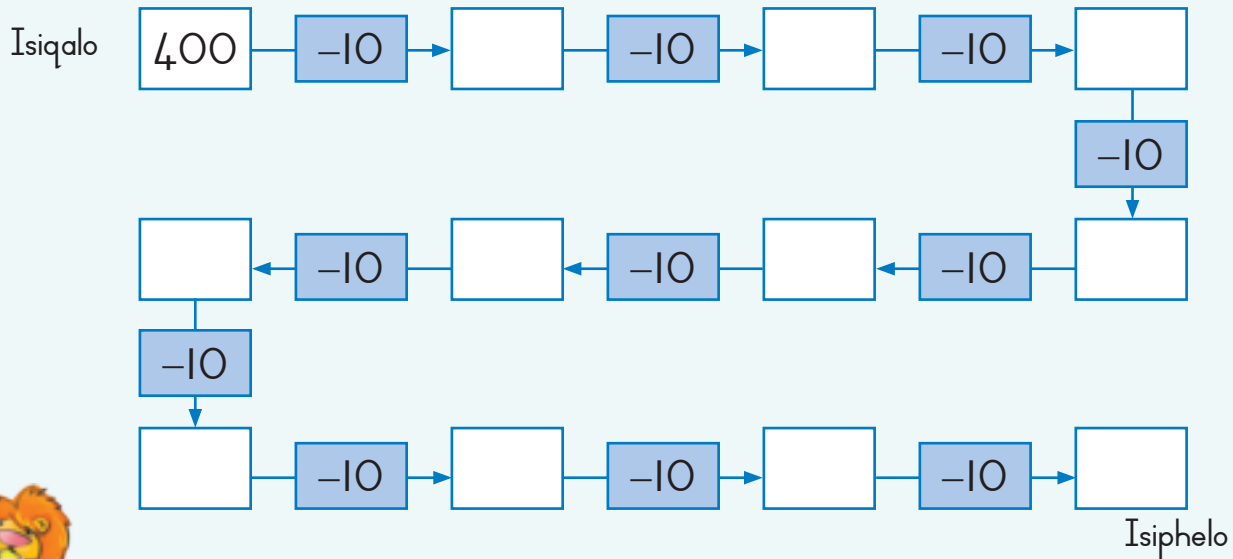

Bhala njengenani elinye.

$$300 + 20 + 4 = \underline{\hspace{2cm}}$$

$$300 + 50 + 3 = \underline{\hspace{2cm}}$$

$$300 + 60 + 2 = \underline{\hspace{2cm}}$$

$$300 + 80 + 1 = \underline{\hspace{2cm}}$$

$$300 + 10 + 5 = \underline{\hspace{2cm}}$$

$$300 + 70 + 7 = \underline{\hspace{2cm}}$$

$$300 + 90 + 9 = \underline{\hspace{2cm}}$$

$$300 + 40 + 8 = \underline{\hspace{2cm}}$$

Bhala amanani ngokulandelelana kwawo ukusuka kwelona lincinci ukuya kwelona likhulu.



Teacher: _____
 Sign: _____
 Date: _____

Ukulinganisa ubunzima



Inani elikhethekileyo

Dibanisa uze ubhale iimpendulo.

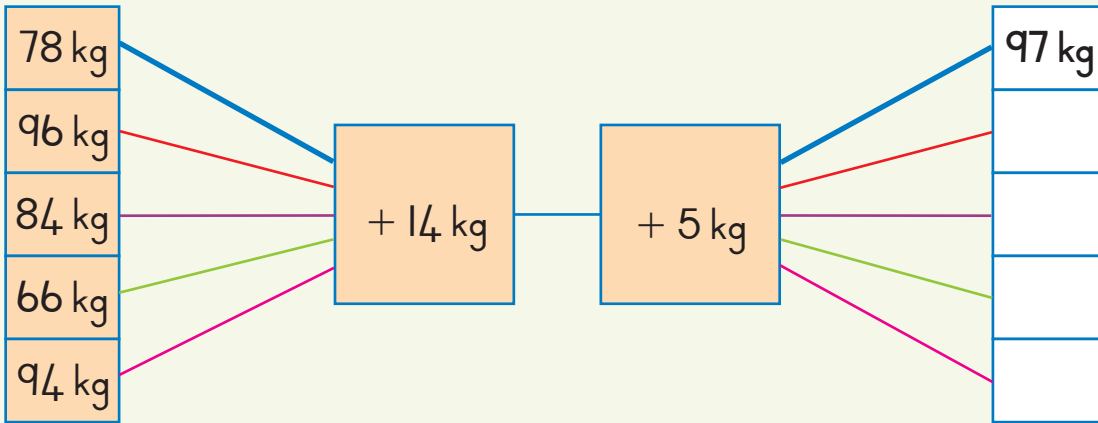

Ukuweza inani nokudibanisa!

Cingisisa!

Udyakalashi ngama-25 kg	Ufudo ngama-98 kg	Imfene ngama-59 kg	Ithole leqwarhashe ngama-88 kg	Ingcwangube li-9 kg

Weza ubunzima besilwanyana ngasinye buye kwelona 10kg lisondeleyo.

Bhala ubunzima besilwanyana ngasinye ngokulandelelana usuke kwesikhaphukhaphu uye kwesinzima.

Qikelela ubunzima bezilwanyana ezi -5 zizonke.



Dibanisa ubunzima bazo











Ndisenokungabi nzima njengawe Fudo, kodwa ngokuqinisekileyo ndiyakhawuleza kunawe!



Amanyathelo



- Sebenzisa izixa zakho oziwezileyo.
- Qikelela ubunzima bezilwanyana ezikumqolo ngamnye.
- Bala iziphumo.
- Thelekisa iziphumo zozibini uze ubhale umahluko.

	Ndiyaqikelela	Ndiyabala	Umahluko
 + 			
 +  + 			
 +  + 			



Ubunzima bukaVusi

Qaphela. Thelekisa. Lungisa.

UVusi udibanisa ubunzima bakhe kobe  no .

Ubunzima babo budibene ngama - 239 kg. UVusi unobunzima obungakanani?
Bonisa impendulo yakho.



Bungakanani ubunzima bam?

Dlalani kwiqela. Tshintshiselanani ...

Dibanisa ubunzima bakho kubunzima bezinye izilwanyana.
Bala isiphumo. Xelela iqela impendulo yakho. Musa ukubabonisa umsebenzi wakho! Mabalinge ukubala ubunzima bakho.



Teacher: _____

Sign: _____

Date: _____

45

Umhla:

Ikota yesi-2



Bala ufike kuma-500

Bala uze ubhale

400

401				405					410
411									420
	422					427			
			434						
					446				
							458		
	462								470
		473				477			
481									490
							499		500



- Bala uye phambili ukusuka kuma -400. Biza amanani njengoko ubala.
- Bhala amanani ashiyelelweyo kwigradi.
- Bhala amanani ali -9 alandela ama -500.

500; _____; _____; _____; _____; _____; _____; _____; _____; _____

- Bala ngezi -2. Bhala amanani asi -8 alandelayo kwipatheni yezi-2.

400; 402; _____; _____; _____; _____; _____; _____; _____; _____

- Bala ngezi -5. Bhala amanani asi -8 alandelayo kwipatheni yezi-5.

400; 405; _____; _____; _____; _____; _____; _____; _____; _____

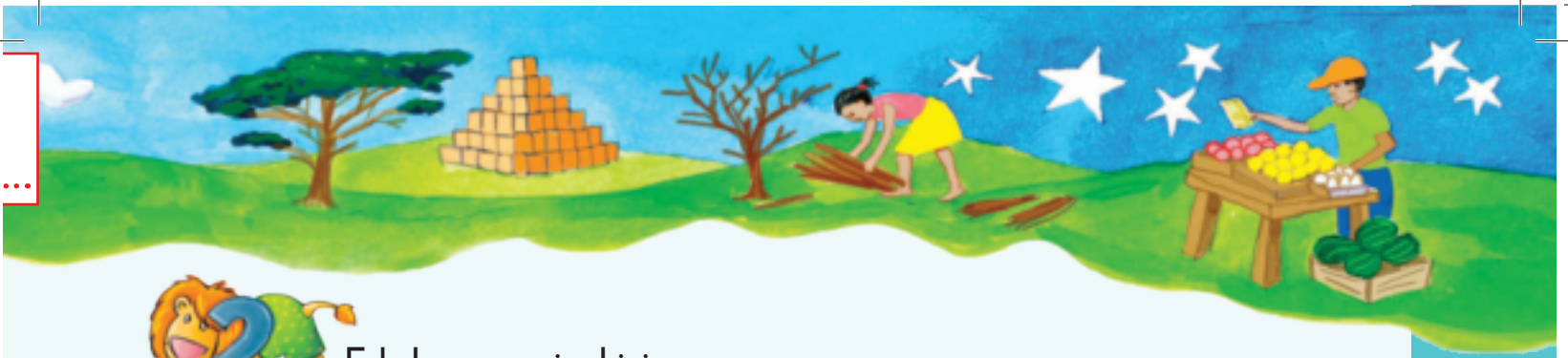

Fakela amanani ashinyweyo.

a. Bala uye phambili ukusuka kuma -400.

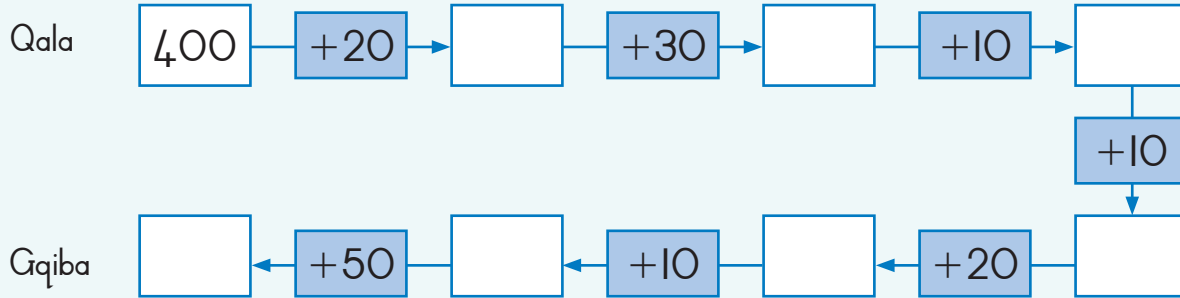

b. Bala ubuye umva ukusuka kuma -500.

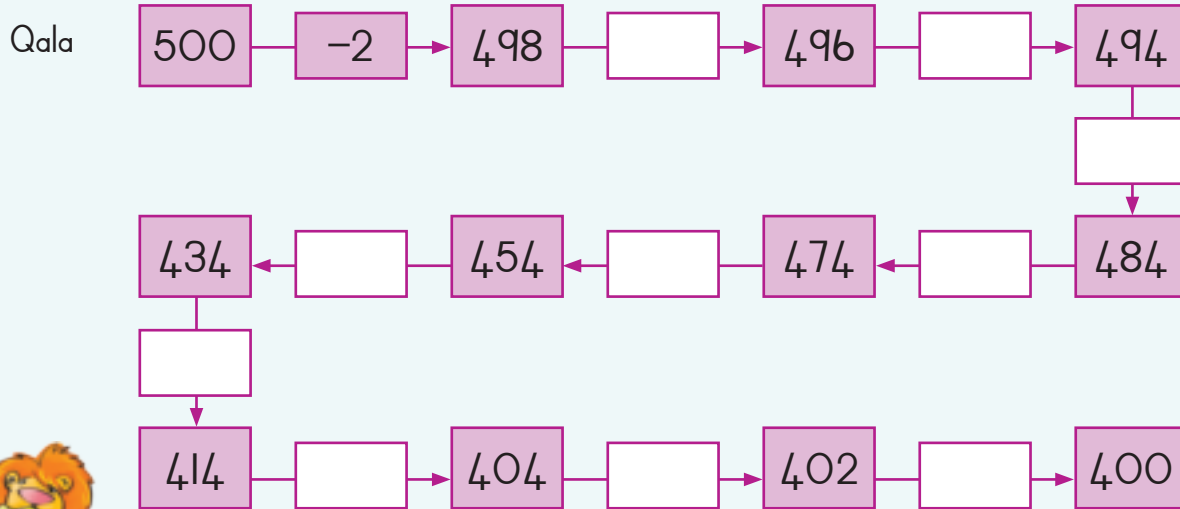

Bonisa amanani. Jonga umzekelo.

Zithini iziphumo?

Sebenzisa amakhadi amanani ubonise isiphumo ngasinye.

$405 + 10$	415	$400 + 10 + 5$
$446 + 10$		
$455 + 10$		

$398 + 10$		
$424 + 10$		
$460 + 20$		

Teacher:

Sign:

Date:

Okunye ukudibanisa nokuthabatha

Ikota yesi-2

200

50

4

200

30

5

400

80

9

489



Siza kusebenzisa indlela yokudibanisa kaBusi nekaDumi.

a. $245 + 231$

Indlela kaBusi

$$= 200 + 200 + 40 + 30 + 5 + 1$$

$$= 400 + 70 + 6$$

$$= 476$$



Indlela kaDumi

$$245 + 231$$

$$= 400 + 70 + 6$$

$$= 476$$



b. $278 + 136$

c. $265 + 148$

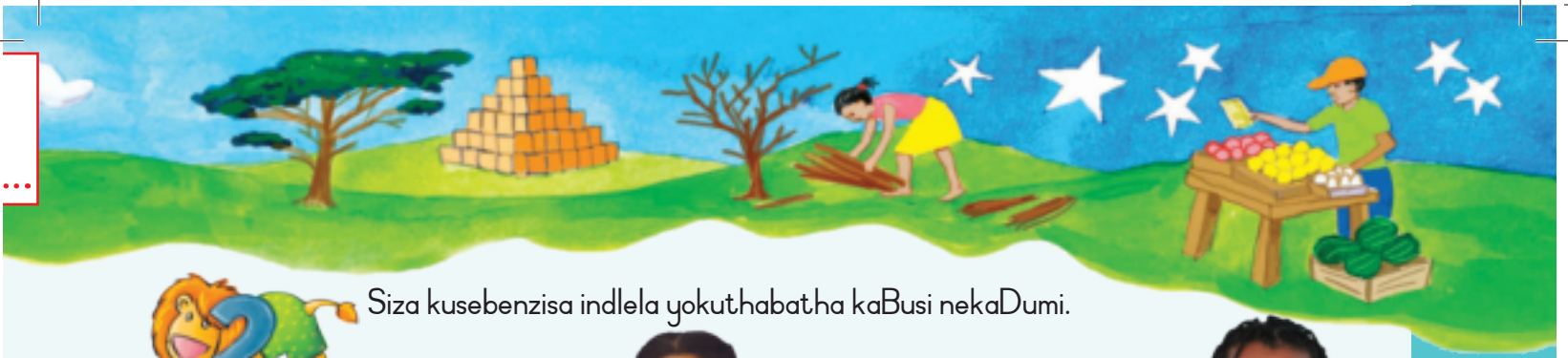

Siza kusebenzisa indlela yokuthabatha kaBusi nekaDumi.

a. $476 - 324$

Indlela kaBusi

$$= 400 - 300 + 70 - 20 + 6 - 4$$

$$= 100 + 50 + 2$$

$$= 152$$



Indlela kaDumi

$$476 + 324$$

$$= 100 + 50 + 2$$

$$= 152$$



b. $489 - 456$

c. $482 - 161$



Ukufikelela kwithagethi

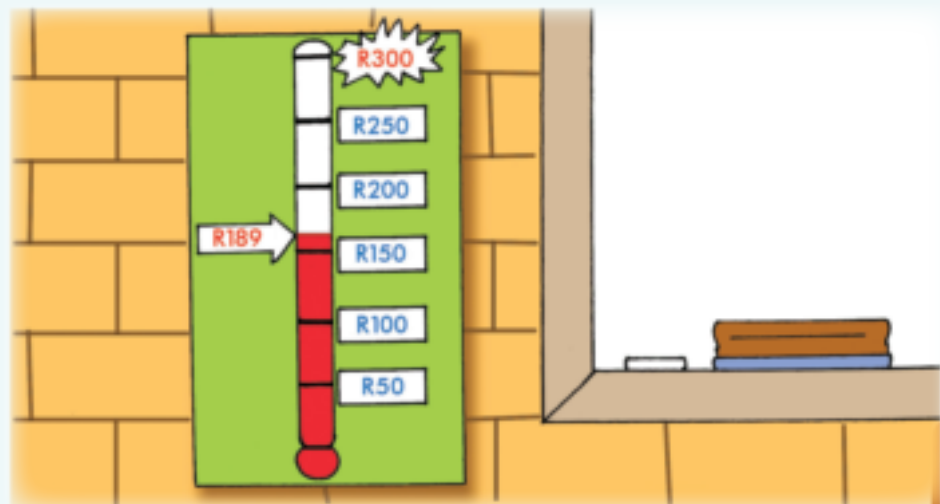

Jongisisa umfanekiso.

Kusafuneka malini ukuze kufikwe kwinjongo yakho?

R

Teacher: _____

Sign: _____

Date: _____

Phucula izakhono zakho



Intaba yemfihlo

Lithini igama leyona ntaba iphakame kakhulu eGauteng? Sebenzisa ikhowudi ufumane impendulo. Tshatisa impendulo nganye ekwitheyibhile nonobumba okwikhowudi.

A	B	C	D	E	F	G	H	I	J	K	L	M
1	2	3	4	5	6	7	8	9	10	11	12	13
N	O	P	Q	R	S	T	U	V	W	X	Y	Z
14	15	16	17	18	19	20	21	22	23	24	25	26

Izikhokelo ezingamanani	Impendulo	Unobumba
Umzekelo: $2 \times 3 \times 3 \times 1 = \square$	18	R
$50 + 50 + 50 + 100 - 200 - 45 = \square$		
$1 + 2 + 7 + 10 + 7 + 1 - 14 = \square$		
$60 - 30 + 50 + 20 - 50 - 15 - 20 = \square$		
$3 + 2 + 7 + 1 + 2 + 1 + 3 = \square$		
$5 + 3 + 30 = 4 + 2 + 12 + \square$		
$100 - 5 - 70 = 20 + \square$		
$36 + 44 - 60 - 22 = \square$		
$10 + 15 = 14 + \square$		
$2 + 1 + 14 + 9 + 14 = 25 + \square$		
$1 \times 2 \times 2 \times 2 \times 2 = \square$		

Igama lentaba



Jonga! Cinga, uphendule!

* * * * * * * * * * * * * *

1 2 3 4 5 6 7 8 9 10 11 12 13 14 15

- a.
- | | |
|--|---|
| Liza kuba yeyiphi imilo inani i -16? Phawula (✓) echanekileyo. | * <input type="radio"/> <input type="radio"/> |
| Liza kuba yeyiphi imilo inani i -18? Phawula (✓) echanekileyo. | * <input type="radio"/> <input type="radio"/> |
| Liza kuba yeyiphi imilo inani i -19? Phawula (✓) echanekileyo. | * <input type="radio"/> <input type="radio"/> |

- b.
- | | |
|---|----------------------------|
| Inani elingama - 50 liza kuba *. | Yinyani okanye Asiyonyani? |
| Inani i -100 liza kuba <input type="radio"/> . | Yinyani okanye Asiyonyani? |
| Inani elingama - 28 liza kuba <input type="radio"/> . | Yinyani okanye Asiyonyani? |

Khangela. Thelekisa. Lungisa.



Yeyiphi engaphezulu?

Ukufumana imali engangee -R2,50 ngosuku kwinyanga kaJuni nekaJulayi.

Okanye ukufumana i -R150 ngowoku -l kuAgasti. Bonisa indlela obale ngayo.

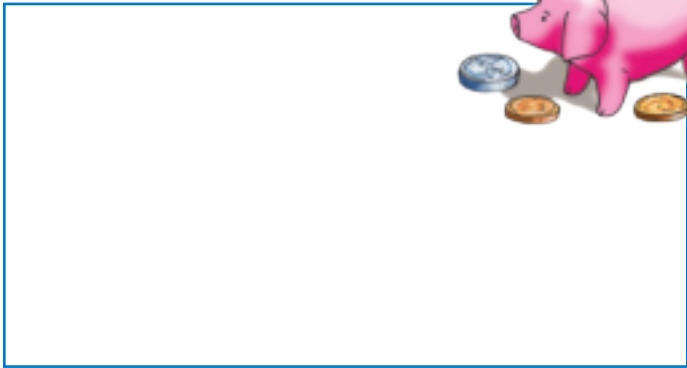

Teacher: _____

Sign: _____

Date: _____

11 12 13 14 15 16 17 18 19 20

Umafana twatse

Uqaphela ntoni ngezi milo?

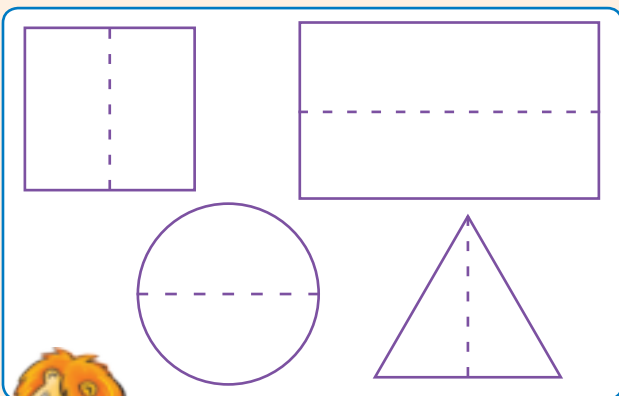

Umgca kamatwatotse (wesimetri) wahlula imilo ibe ziziqingatha ezibini ukuze isiqingatha ngasinye sifane twatse nesinye oku komfanekiso wakho esipilini.



Krwela umgca owahlula imilo nganye ngokulinganayo

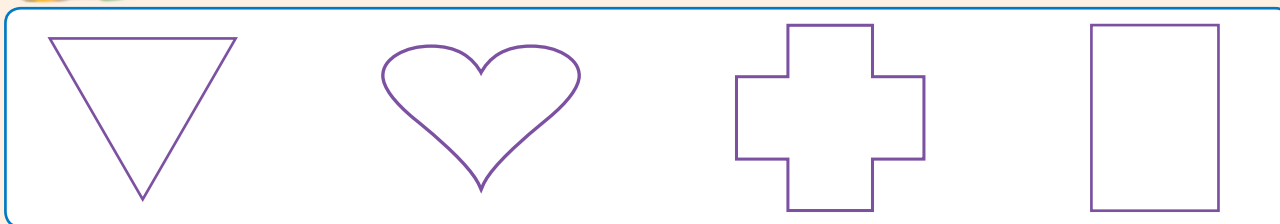

Ingaba umgca ochokoziweyo ngumgca owahlula ngokulinganayo okanye asinguwo? Biyela ngesangqa u-E (EWE) okanye u-H (Hayi).

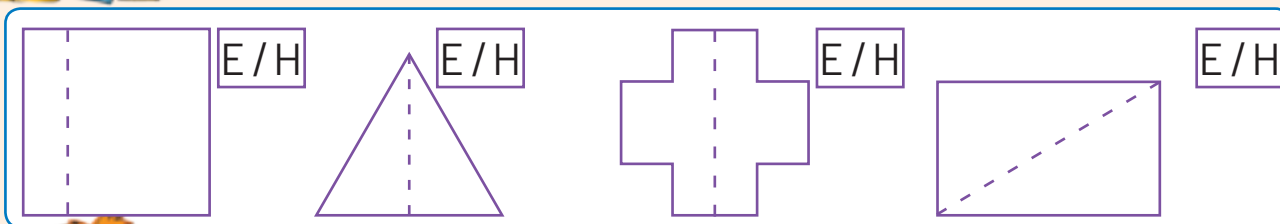

Ingaba ngumgca kamafana twatse lo? Ngoba kutheni?

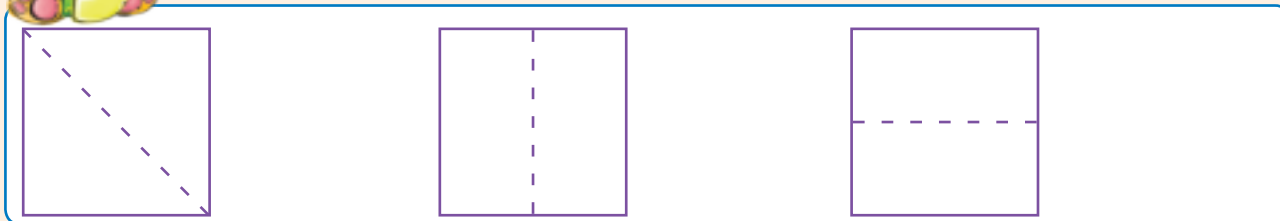

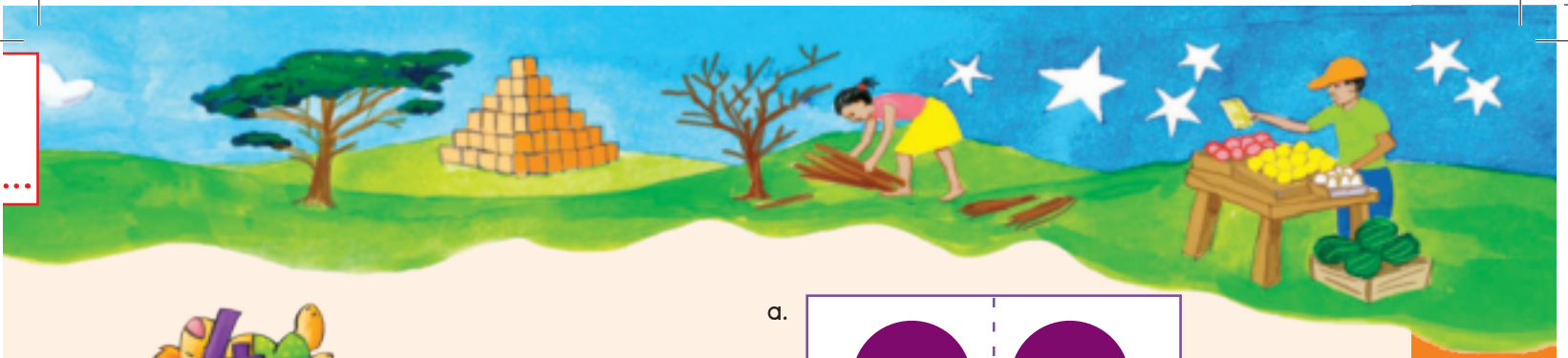

Zoba iimilo wenze umfanekiso kamatwatotse.

Sikwenzele owokuqala.

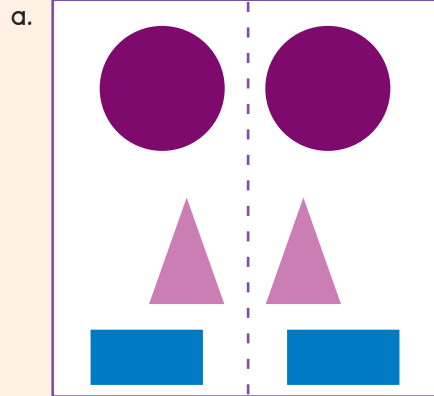

b.

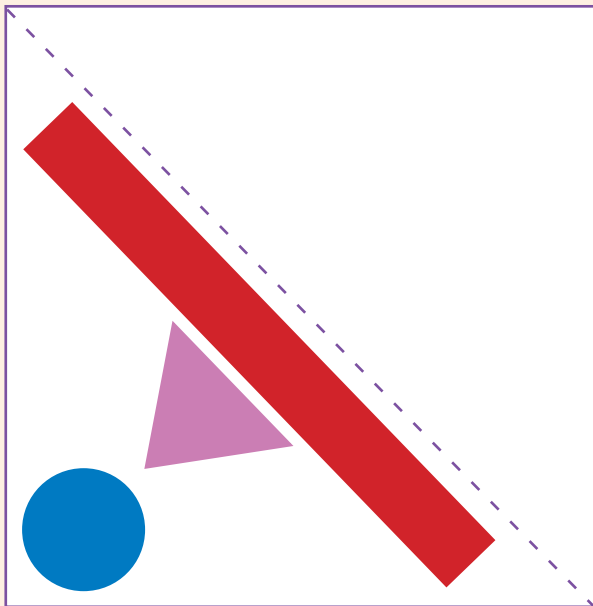

c.

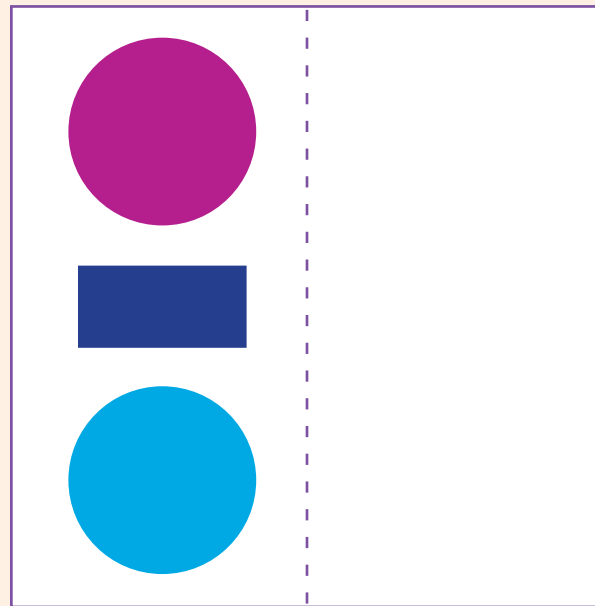

Ziyilele eyakho ikhaphethi kamatwatotse usebenzise iimilo.

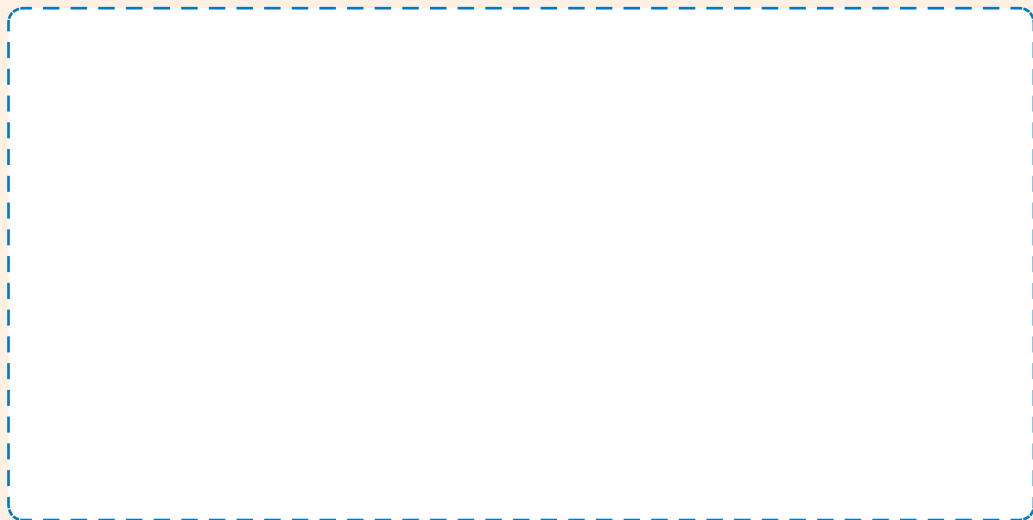

49

Umhla:

Ikota yesi-2

Ukuya kuma-500



Bala ama-apile

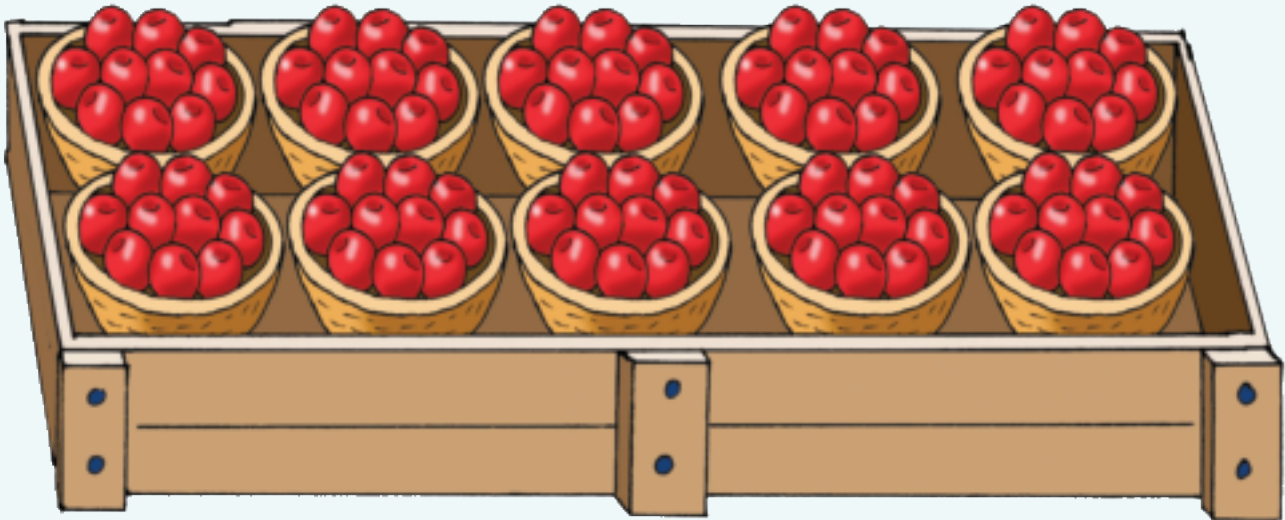
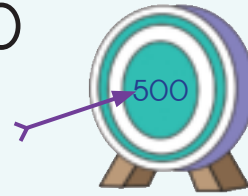

Gqibezela uphindaphinde

Iibhasikithi e-1 ithatha ama-apile a _____.	$1 \times 10 = 10$
Iibhasikithi ezi-3 zinama-apile a _____.	$3 \times 10 =$
Iibhasikithi ezi-5 zinama-apile a _____.	
Iibhasikithi ezi-4 zinama-apile a _____.	
Iibhasikithi ezi-2 zinama-apile a _____.	

Iibhokisi e-1 ithatha ama-apile ali-100.	iibhokisi ezi-2 zithatha ama-apile a __.
Iibhokisi ezi-3 zithatha ama-apile a __	iibhokisi ezi-4 zithatha ama-apile a __.
Iibhokisi ezi-5 zithatha ama-apile a __	iibhokisi ezi-2 ezizele kangangesiqinagatha zinama-apile a __.

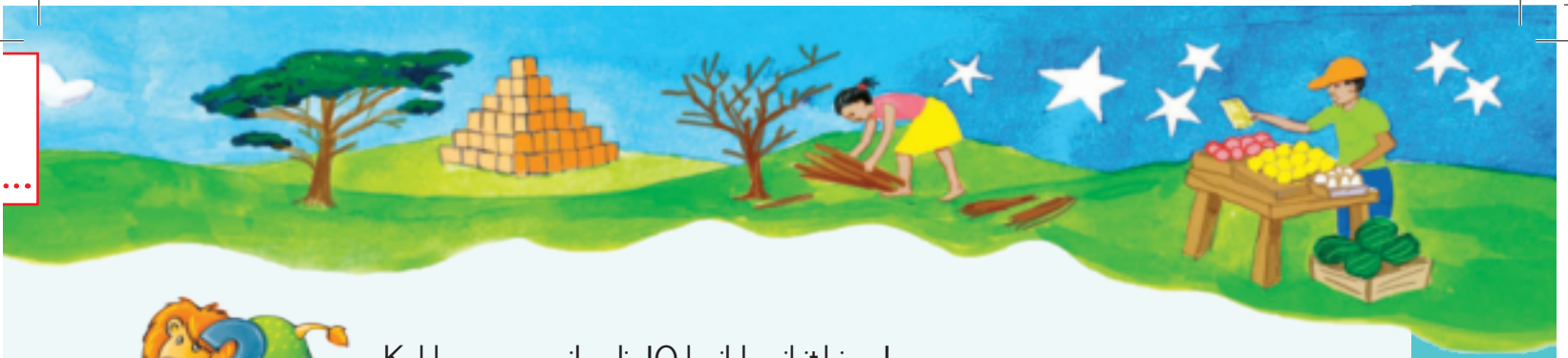

Kukho ama-apile ali -10 kwibhasikithi e -1.

Kukho iibhasikithi ezi _____ kwibhokisi enye.

Kukho ama-apile a _____ kwibhokisi enye.

Mangaphi ama-apile akhoyo ewonke? _____

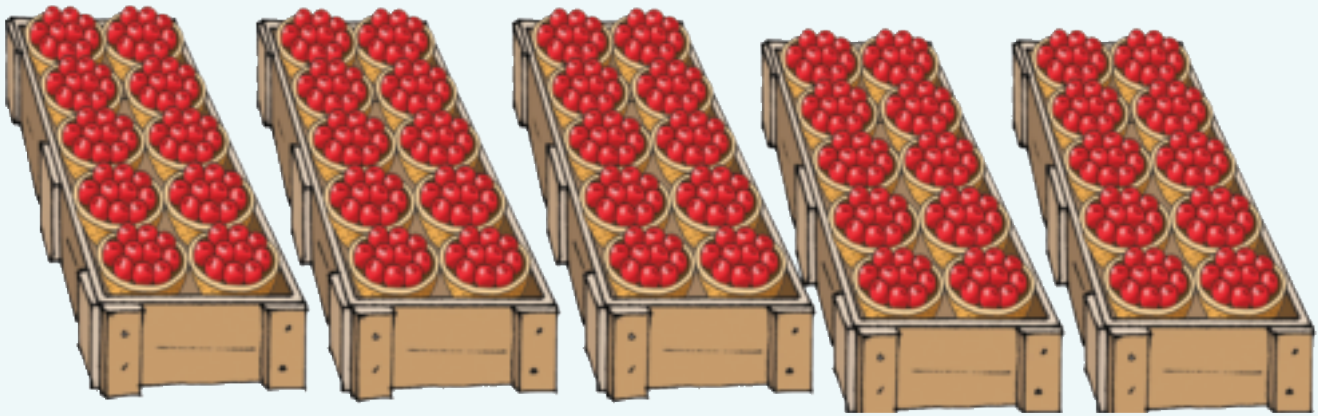

Ukubala, ukubonisa nokubhala

300

40

5

Qala usebenzise amakhadi amanani ubonise isiphumo ngasinye. Bhala ke ngoku inani.

3 iikreyithi + 4 iibhasikithi + 5 ama-apile = 345 ama-apile

4 iikreyithi + 5 iibhasikithi + 7 ama-apile = _____ ama-apile

5 iikreyithi + 2 iibhasikithi + 3 ama-apile = _____ ama-apile

4 iikreyithi + 7 iibhasikithi + 2 ama-apile = _____ ama-apile



Teacher: _____
Sign: _____
Date: _____

Ukuphindaphinda nokwahlula (10)





Ukubala ama-apile

Gqibezela itheyibhile

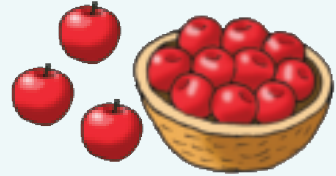
Zingaphi iibhasikithi ezinama -apile?



Ama -apile 	10	20	30	40	50
Iibhasikithi 	1	2			
isibalo so - ÷					$50 \div 10 = 5$
isibalo so - ×					$5 \times 10 = 50$



Yahlulela abantwana ama -apile. Yenza umfanekiso. Bhala isibalo sokwahlula -hlula nesokuphinda -phinda ukuze uhlole impendulo yakho.

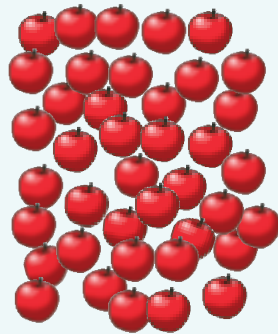

Hlola iimpindulo zakho

$$\square \div \square = \square$$

$$\square \times \square = \square$$





b.

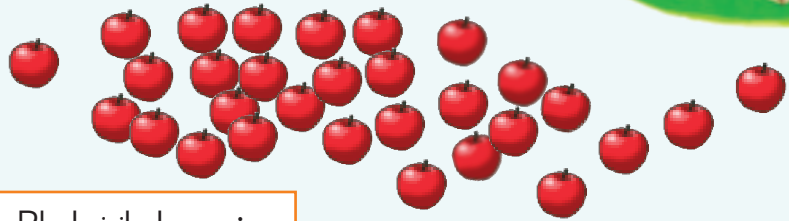
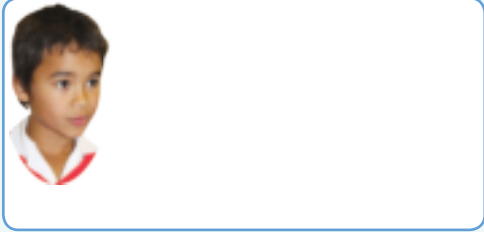

Bhala isibalo so - ÷

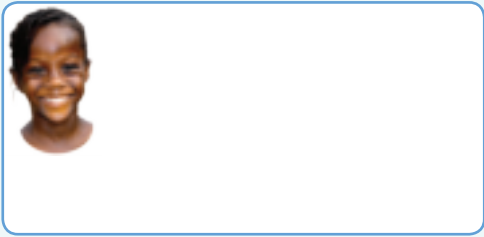

Bhala isibalo
so - × ukuze uhlole
iimpendulo zakho

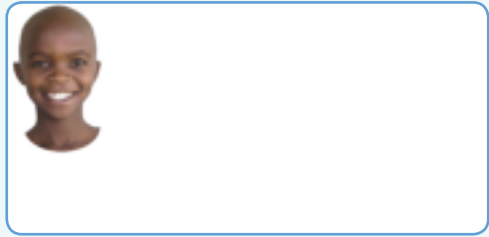

Sebenzisa amanani uzenzele ezakho izivakalisi zamanani.



Umzekelo

÷ $40 \div 10 = 4$

× $4 \times 10 = 40$

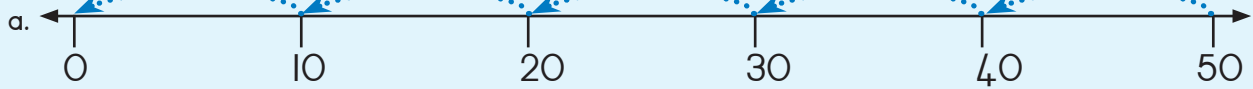

÷

×



÷

×



÷

×



Bhala inani elincinci nge -10 nelikhulu nge -10 kunenani olinikiweyo.

, 460,

, 390,

, 500,

Teacher: _____
Sign: _____
Date: _____



Bala ngezibini (2)

Ukubala ngezi-2 usiya phambili nokubuya umva

- a. 232; 234; _____; _____; _____; 242; _____; _____; 248
- b. 500; _____; 496; _____; _____; 490; _____; _____; _____
- c. 460; _____; _____; 400; _____; 360; _____; _____; _____
- d. 341; _____; 361; _____; _____; 391; _____; 411; _____; _____



Izibini zeeglavu



- a. Zingaphi izibini zeeglavu kumqolo omnye? _____
- b. Zingaphi iiglavu ezinganye kumqolo omnye? _____
- c. Mingaphi imiqolo? _____
- d. Zingaphi iiglavu zizonke? _____
- e. Bonisa indlela obale ngayo.
- f. Bhala impendulo yakho njengesivakalisi samanani.











$$\underline{\hspace{2cm}} \times \underline{\hspace{2cm}} = \underline{\hspace{2cm}}$$



Zingaphi iiglavu?

Bhala kwiitheyibhile.

a.

Izibini 	 1	 10	 5	 50	 4	 40	 3	 30	 100
Izibini zeeglavu	2								

b.

Iglavu enye	20	21	70	73
Izibini ezinokwenziwa				
Iglavu ezinganye ezishiyekileyo				



Bala ngezibini

a. Leliphi inani eliphakathi?

264, _____, 268	391, _____, 395	414, _____, 410
-----------------	-----------------	-----------------

b. Bhala amanani amabini alandelayo.

373, 375, 377, 379	480, 482, _____, _____	262, 264, _____, _____
--------------------	------------------------	------------------------

c. Bhala amanani amabini alandelayo.

346, 348, _____, _____	415, 417, _____, _____	297, 299, _____, _____
------------------------	------------------------	------------------------



Teacher: _____

Sign: _____

Date: _____



Ucwangciso lwegadi

Gangatha ngeethayile



UNkosikazi Mabena uneethayile zomgangatho ezintle.

Uzisebenzisa ukugangatha ecaleni kwegadi yakhe.

Kunezikwere ezi-6 ezilinganayo.

Ndingazibeka njani?

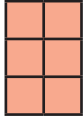

Ndingenza uluhlu olunye ngeethayile ezi-6.	Ndingenza izintlu ezi-2 ngeethayile ezi-3 kuluhlu.	Ndingenza izintlu ezi-3 ngeethayile ezi-2 kuluhlu ngalunye.
		
$6 \times 1 = 6$	$3 \times 2 = 6$	$2 \times 3 = 6$

Ngoku lithuba lakho!

Fakela umbala kwiibloko zeethayile ubonise indlela onokuzicwangcisa ngayo izikwere zeethayile ezi-8 nezili-9.

Bhala izivakalisi -manani kumzobo ngamnye.

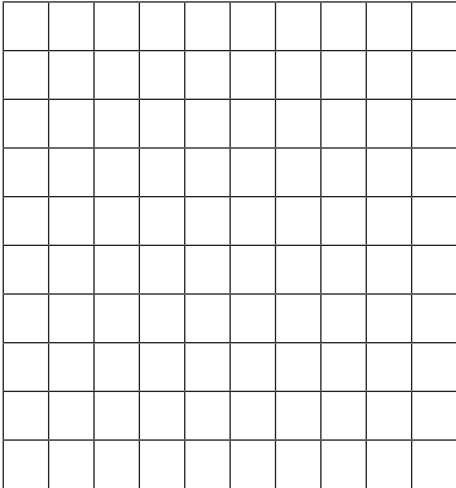
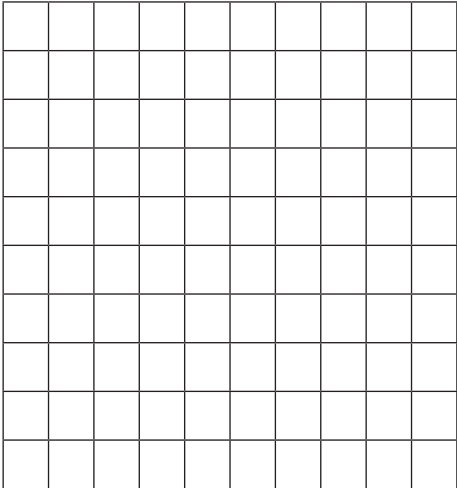
izikwere ezisi-8	izikwere ezili-9
	



Cwangcwisa iithayile ezili-12

UThabo unezikwere zeethayile ezi -12 zokugangatha ecaleni wendlu. Mncedise afumane zonke iindlela anokwenza ngazo oko. Bhala isivakalisi samanani sendlela nganye.

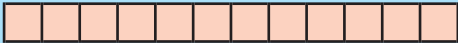
Umzekelo: 	$1 \times 12 = 12$ $12 \times 1 = 12$



Cwangcwisa iithayile ezingama-24

- Sebenzisa igradi ekwiphepha lomsiko 2.
- Fakela umbala iibloko ezingama -24 ngendlela ezahlukeneyo.
- Bhala izivakalisi manani utshatise imizobo nganye -nganye.



Ndiyakwazi ukuphindaphinda!

$12 = 2 \times \square$	$3 \times \square = 12$	$9 = \square \times 3$
$6 = 3 \times \square$	$\square \times 3 = 12$	$24 = 3 \times \square$

Teacher: _____

Sign: _____

Date: _____



Sebenzisa izihlanu



Zazi izi-5 zakho

Fakela iimpendulo.

	1	2	3	4	5	6	7	8	9	10
$\times 5$	5									



Bala amakhandlela



- a. Mangaphi amakhandlela akwibhokisi nganye? _____
- b. Zingaphi iibhokisi ezikumqolo ngamnye? _____
- c. Mangaphi amakhandlela akumqolo ngamnye? _____
- d. Mangaphi amakhandlela ewonke? _____



Bonisa impendulo

Phawula (✓) izivakalisi zamanani ezibonisa itotali yenani lamakhandlela.

a. $5 \times 3 \times 3 = \square$ b. $15 \times 3 = \square$ c. $3 \times 5 \times 5 = \square$ d. $15 \times 5 = \square$



Bala uye phambili nasemva ngezi-5

- a. 85; _____; _____; 70; _____; _____; 55; _____; _____
- b. 240; _____; _____; 255; _____; _____; _____; _____; 280
- c. 405; _____; 395; _____; _____; 380; _____; _____; 365; _____



Qokelela imali eziinkozo ze-R5



Abantwana baqokelela iingqekembe ze -R5. Kufuneka baqokelele iingqekembe ze -R5 ezingaphi ukuze babe ne -R___. Sikwenzele ezimbini zokuqala.

$R5 \div R5$ = 1 Inqekembe (yemali)	$R10 \div R5$ = 2 iingqekembe	R15? _____	R20? _____	R25? _____
R30? _____	R35? _____	R40? _____	R45? _____	R50? _____

$2 \times R5 =$

$3 \times R5 =$

$4 \times R5 =$

$6 \times R5 =$

Uyayibona ipatheni?



Phindaphinda ngezi-5

Umzekelo: $1 \times 5 = 5$; $11 \times 5 = 55$; $21 \times 5 = 105$

Cingisisa! Thetha ngokwaziyo nokuyinyaniso!

1	2	3	4	5	6	7	8	9	10
5	10								
11	12	13	14	15	16	17	18	19	20
55									



Teacher: _____
Sign: _____
Date: _____

Umhle:

Ukusebenza ngexesha

Zoba amaxesha

Icala emva kwentsimbi yesi-5	Ngumkhono phambi kwentsimbi yeshumi elinanaye	Ngumkhono emva kwentsimbi ye-12	12:45	6:15
				4:30

Amaqina angexesha

Umama kaNomsa ulishya ikhaya emva kwemini nge-2:30. Ubuya ngo-5:15 emalanga. Uba nexesha elingakanani engekho khaya?

Sinokusebenzisa umgca -manani wexesha ukubala oko. Beka umnwe wakho ku-2:30, ixesha elililo ngokho.

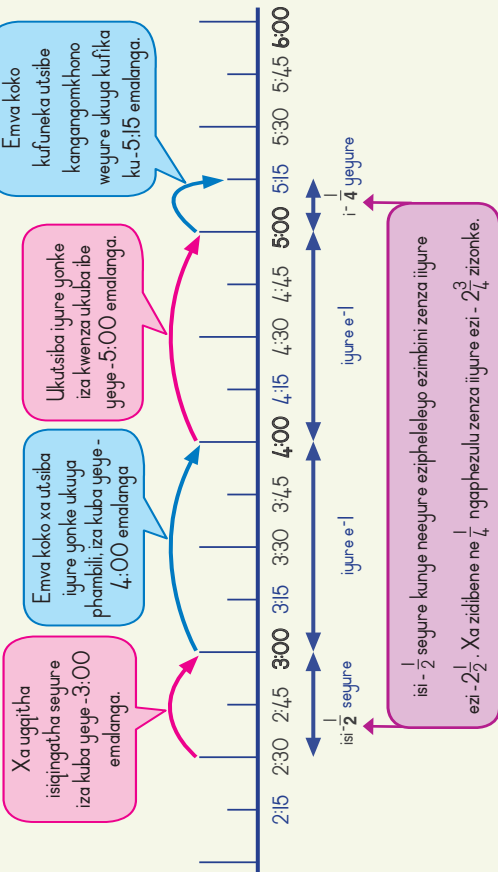

Izibalo zexesha

Sombulula ingxaki nganye. Sebenzisa imigca manani ikuncedise.

a. UNonkolo undwendwela utata wakhe eklinikhi ngo-15:45 emalanga. Umshiya ngo-17:15 emalanga. Uhlala ixesha elingakanani.

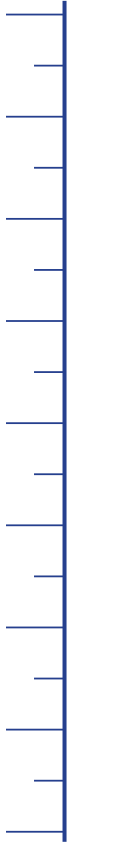

b. UNjongo uya epakini ngo-10:45 kusasa. Ubuyela ekhaya nge-12:30 emini. Ebergenkho ixesha elingakanani?

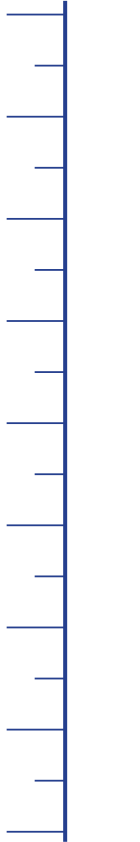

c. UThumeka uqalisa ukufunda ngo-13:15. Ugqiba ngo-14:45. Ufunde ixesha elingakanani uThumeka?

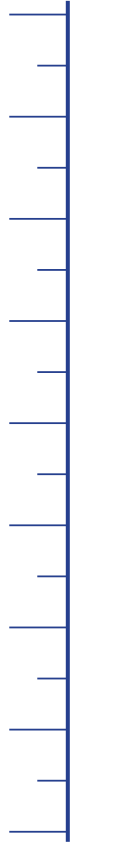

Gaphela. Thelekisa. Lungisa.

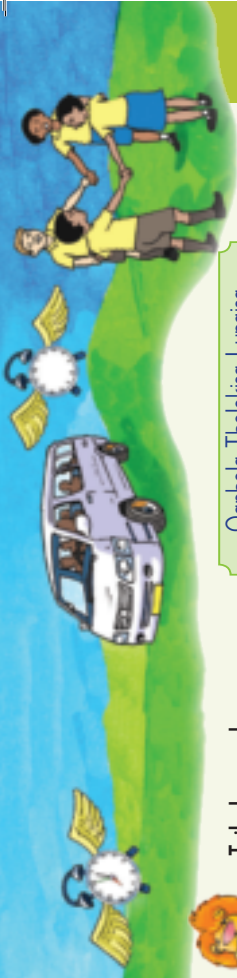

Teacher: _____
Sign: _____
Date: _____

Umhla:



Bala ngezi-3 nangezi-4

Iimbiza ezinemilenze eni-3



Dibanisa uze ubhale iimpendulo.



- a. Zingaphi iimbiza kumqolo ngamnye? _____
 - b. Mingaphi imilenze kumqolo ngamnye? _____
 - c. Mingaphi imiqolo yeembiza? _____
 - d. Mingaphi imilenze iyonke? Bonisa indlela obale ngayo.
- Phawula (✓) izivakalisi manani ezibonisa itotali.
 $21 \times 7 = \square \quad 3 \times 7 \times 3 = \square \quad 3 \times 4 \times 2 = \square \quad 21 \times 3 = \square$



Mingaphi imilenze?

1 imbiza	3 imilenze	10 iimbiza	imilenze	5 iimbiza	imilenze
2 iimbiza	imilenze	15 iimbiza	imilenze	12 iimbiza	imilenze
5 iimbiza	imilenze	13 iimbiza	imilenze	14 iimbiza	imilenze



Imilenze yetafile

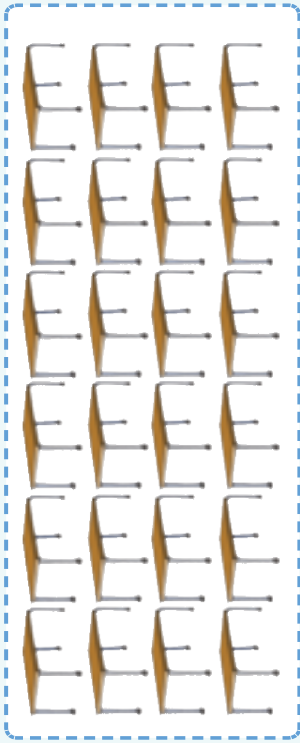

- a. Zingaphi iitafile kumqolo ngamnye? _____
- b. Mingaphi imilenze kumqolo ngamnye? _____
- c. Mingaphi imiqolo yeetafile? _____
- d. Mingaphi imilenze iyonke? Bonisa indlela obale ngayo.



Efektri

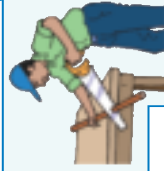

Umchweli wenza iitafile. Uqala ngemilenze.

Wenze engama -48 ukuza kuthi ga ngoku. Angenza iitafile ezingaphi?

Kufuneka imilenze emingaphi ukuze enze enye itafile.



Gqibezela igridi ngokufakela iimpendulo.

	2	3	4	5	8	10	11	12
$\times 3$								
$\times 4$								



Teacher: _____
 Sign: _____
 Date: _____

Umhle:

Bala ngama -50

Umntwana omnye, ingubo enye!
Bangaphi abantwana? Qikelela uze ubabale.



Ingubo Yethemba

Gcina abantwana bethu befudumele

NPO 123-098

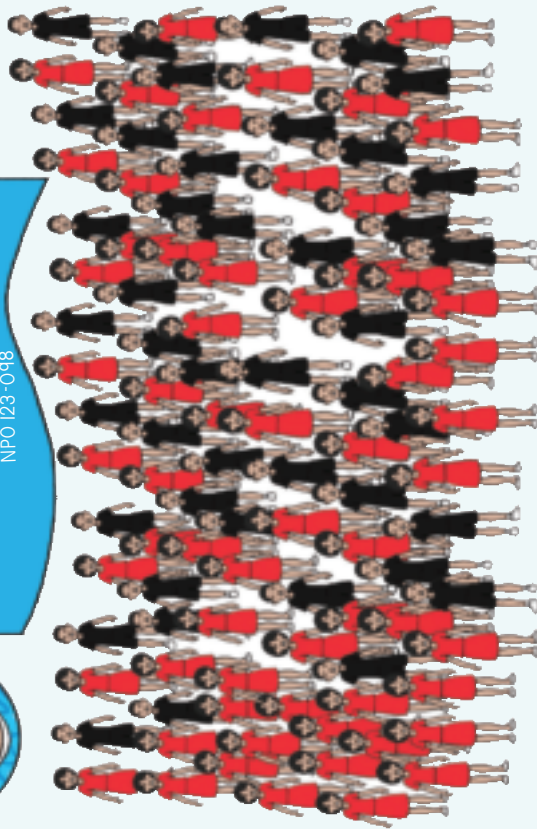

Bonke abantwana abasemfanekisweni bafumana iingubo.
Bangaphi abantwana abakhoyo?

Qikelela	Bala	Thelekisa

Mangaphi amakhwenkwe? _____ Mangaphi amantombazana? _____



Bahlawula malini?

UCwazi
uthenga ezi-2.



Uhlawula
R

UNkosikazi Siko
uthenga ezi-5



Uhlawula
R



Kwivenkile yakwa Thombi

Bahlawula
R

bathenga



ezingama -20.

Nikela ngoku!
ama-R50
engubo e-1



5	ngama-R50 = R250	10	ngama-R50 = R500
4	ngama-R50 = R_____	15	ngama-R50 = R_____
3	ngama-R50 = R_____	6	ngama-R50 = R_____
7	ngama-R50 = R_____	12	ngama-R50 = R_____
8	ngama-R50 = R_____	9	ngama-R50 = R_____



Iza kuthatha ixesha elingakanani? Sebenzisa ikhalenda.

Ikhasi yebanga lesi-3 iqokelela imali eza kuthenga ngayo iingubo ezi-4.

Baqokelela i-R5 ngosuku kwiintsuku ezi-5 zeveki.

Kufuneka iiveki ezingaphi ukuze baqokelele imali yeengubo?



Teacher: _____
Sign: _____
Date: _____

Umhla:

Amaqhezu: iziqingatha neekota

Yahlula iibhola ngokulinganayo phakathi kweebhokisi.

• Zingaphi iibhola kwibhokisi nganye? <input type="text"/>	• Zingaphi iibhola ezikwibhokisi nganye? <input type="text"/>
• Zingaphi iibhola ezikwibhokisi emsobo? <input type="text"/>	• Zingaphi iibhola ezikwibhokisi emsobo? <input type="text"/>
• Leliphi iqhezu elikwibhokisi emsobo? <input type="text"/>	• Leliphi iqhezu elikwibhokisi emsobo? <input type="text"/>



Jonga umfanekiso uze uphendule imibuzo.

Zingaphi izangqa ozibalileyo? <input type="text"/>	Ubalile izangqa ezingaphi? <input type="text"/>
Nika isi- $\frac{2}{3}$ sezangqa? <input type="text"/>	Nika i- $\frac{1}{2}$ yezangqa? <input type="text"/>
<input type="text"/>	Nika i- $\frac{2}{4}$ yezangqa? <input type="text"/>
<input type="text"/>	Nika i- $\frac{3}{4}$ yezangqa? <input type="text"/>
<input type="text"/>	Nika i- $\frac{4}{4}$ yezangqa? <input type="text"/>



<input type="text"/>	<input type="text"/>	<input type="text"/>	<input type="text"/>
Faka umbala kwi- $\frac{1}{2}$ semilo nganye. <input type="text"/>	<input type="text"/>	<input type="text"/>	<input type="text"/>
Faka umbala kwi- $\frac{1}{4}$ yemilo nganye. <input type="text"/>	<input type="text"/>	<input type="text"/>	<input type="text"/>
Faka umbala kwi- $\frac{2}{4}$ yemilo nganye. <input type="text"/>	<input type="text"/>	<input type="text"/>	<input type="text"/>
Faka umbala kwi- $\frac{3}{4}$ semilo nganye. <input type="text"/>	<input type="text"/>	<input type="text"/>	<input type="text"/>



Jonga iziqingatha zamaghezu



a. Zingaphi iziqingathha ($\frac{1}{4}$) eziya kwenza into enye epheleleyo?

Zingaphi iikota ($\frac{1}{2}$) eziya kwenza into epheleleyo?

Zingaphi iikota eziya kwenza isiqingathha?

b. Jonga imifanekiso uze ubhale iqhezu lendawo enombala.

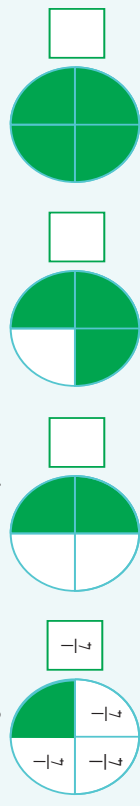

c. Leliphi iqhezu elikhulu, sisi- $\frac{1}{2}$ okanye yi- $\frac{1}{4}$?









Teacher: _____
Sign: _____
Date: _____

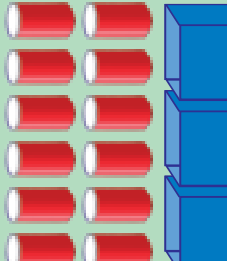

Umhle:

Amaqhezu: iziqingatha, izithathu nezithandathu

Yahlula iitoti (isislinda) ngokulinganayo phakathi kweebhokisi.

		
		
Iitoti zizonke: <input type="text" value="12"/>	<input type="text" value="6"/>	<input type="text" value="6"/>
• Zingaphi iitoti ezikwibhokisi emsobo?	<input type="text" value="6"/>	<input type="text" value="6"/>
• Leliphi iqhezu elikwibhokisi emsobo?	<input type="text" value="1/2"/>	<input type="text" value="1/2"/>

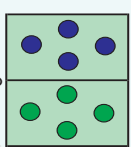
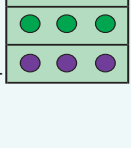
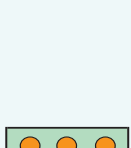
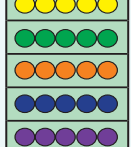
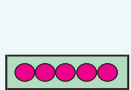
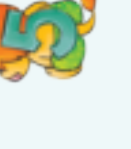
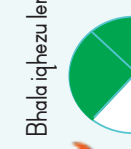
Jonga imifanekiso uze uphendule imbuzo.

	<input type="text"/>	Nika isi- $\frac{1}{3}$ sezangqa?	<input type="text"/>
	<input type="text"/>	Nika isi- $\frac{2}{3}$ sezangqa?	<input type="text"/>
	<input type="text"/>	Nika isi- $\frac{3}{3}$ sezangqa?	<input type="text"/>
	<input type="text"/>	Nika i- $\frac{1}{6}$ sezangqa?	<input type="text"/>
	<input type="text"/>	Nika i- $\frac{2}{6}$ sezangqa?	<input type="text"/>
	<input type="text"/>	Nika i- $\frac{3}{6}$ sezangqa?	<input type="text"/>
	<input type="text"/>	Nika i- $\frac{4}{6}$ sezangqa?	<input type="text"/>
	<input type="text"/>	Nika i- $\frac{5}{6}$ sezangqa?	<input type="text"/>

Zingaphi izangqa ozibalayo?

Nika isi- $\frac{1}{2}$ sezangqa?

Nika isi- $\frac{2}{3}$ sezangqa?

Nika isi- $\frac{1}{3}$ sezangqa?

Nika i- $\frac{2}{6}$ sezangqa?

Nika i- $\frac{3}{6}$ sezangqa?

Nika i- $\frac{4}{6}$ sezangqa?

Nika i- $\frac{5}{6}$ sezangqa?



- Bonisa isi- $\frac{1}{2}$ sobude berula. Silingana ne... cm.
- Bonisa isinye kwisithathu kwirula. Silingana ne... cm
- Bonisa isinye kwisithandathu kwirula. Silingana ne... cm



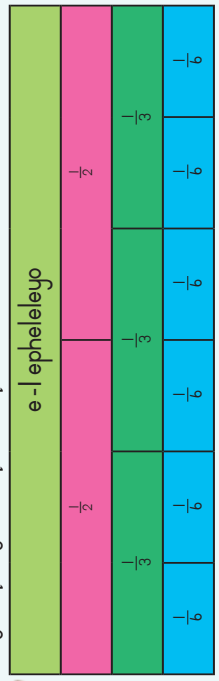

Jonga iziqingatha zamaqhezu. Gqibezela izivakalisi.

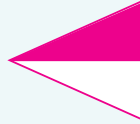

- Kukho iziqingatha ezi... kwinto enye epheleleyo.
- Kukho izithathu ezi... kwinto enye epheleleyo.
- Kukho izithandathu ezi... kwinto enye epheleleyo.
- Kukho izithandathu ezi... kwisiqingatha.
- Kukho izithandathu ezi... kwisithathu.

Bhalala iqhezu lendawo enombala.

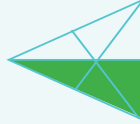
	<input type="text"/>		<input type="text"/>
	<input type="text"/>		<input type="text"/>

Biyele ngesangqa iqhezu elikhulu.

a.	$\frac{1}{2}$	$\frac{1}{3}$
b.	$\frac{1}{2}$	$\frac{1}{6}$
c.	$\frac{1}{2}$	$\frac{2}{6}$

Teacher: _____
Sign: _____
Date: _____

Umhla:

Amaqhezu: izihlanu

Yahlula iitoti zingene kwiibhokisi ezi -5.



- Kwishlanu esinye seebhokisi kukho iitoti ezi .
- Kwizihlanu ezibini zeebhokisi kukho iitoti ezi .
- Kwizihlanu ezithathu zeebhokisi kukho iitoti ezi .
- Kwizihlanu ezine zeebhokisi kukho iitoti ezi .
- Kwizihlanu ezihlanu zeebhokisi kukho iitoti ezi .



Jonga umfanekiso uze uphendule imibuzo.



- Zingaphi iitshokolethi ezisebhokisini?
- Isihlanu esinye seetshokolethi silingana ne
 - Izihlanu ezibini zeetshokolethi zilingana ne
 - Izihlanu ezithathu zeetshokolethi zilingana ne
 - Izihlanu ezine zeetshokolethi zilingana ne
 - Izihlanu ezihlanu zeetshokolethi zilingana ne
 - Ngosuku lokuqala ndatya isi - $\frac{5}{5}$ seetshokolethi. Zingaphi iitshokolethi ezishiyekileyo?
 - Ngosuku lwesibini ndatya esinye isi - $\frac{5}{5}$. Zingaphi iitshokolethi ezishiyekileyo?

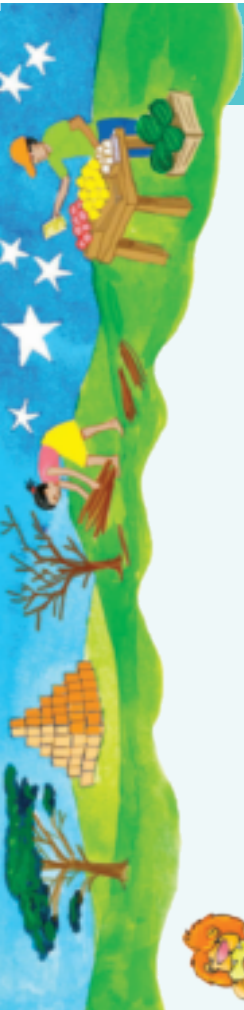

Fakela umbala kwi - $\frac{1}{5}$ serula yokulinganisa

d.



Jonga iziqwenga zamaqhezu uze uphendule imibuzo.

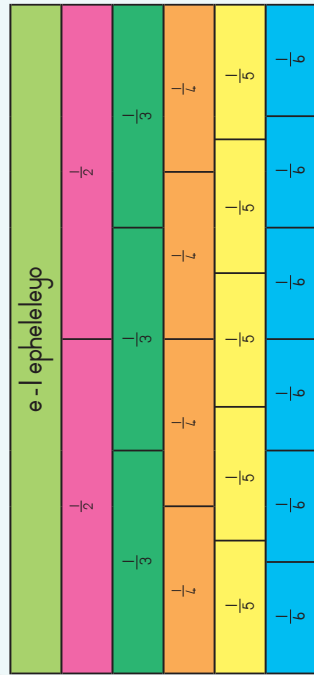

Biyela ngesangqa sikhulu- okanye sincinci-

- a. $\frac{1}{2}$ (sikhulu) / sincinci kune - $\frac{1}{4}$.
- b. $\frac{1}{3}$ sikhulu/ sincinci kune - $\frac{1}{2}$.
- c. $\frac{1}{5}$ sikhulu/ sincinci kune - $\frac{1}{6}$.
- d. $\frac{1}{6}$ sikhulu/ sincinci kune - $\frac{1}{3}$.
- e. $\frac{3}{6}$ sikhulu/ sincinci kune - $\frac{2}{5}$.



Teacher: _____
Sign: _____
Date: _____

Umhle:

Izinto ezinemilinganiselo emi-3 (3D)



- Bala iibhokisi (iprizimu)
- Bala iibhola (iingqakumba)
- Bala iisilinda



Zonke ezi zinto ziibhokisi

Zenze ngamaphepha aphuma kuMisiko 3 naMisiko 4.

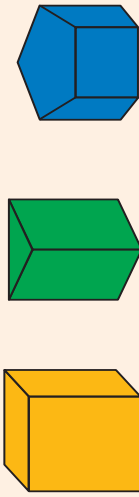

Umphezulu osicaba ubizwa ngokuba bubuso. Neamathelesa okanye zoba ubuso obuncumileyo kubuso ngabunye bebhokisi. Zingaphi iibuso ozincamathelelisileyo:

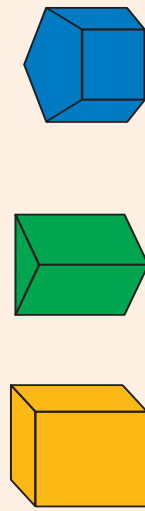

iTjhubhu iprizimu

Ingaba iibuso zeprizimu zimcaba okanye zigobile?

Yenza ke ngoku isilinda ngaphepha loMisiko 4.

Ingaba iibuso zesilinda zimcaba okanye zigobile?



Sebenzisa izinto zakho wakhe oku kulandelayo.

Chaza indawo yesilinda usebenzise la magama.

Ecaleni

Ngqambili

Ngaphezulu

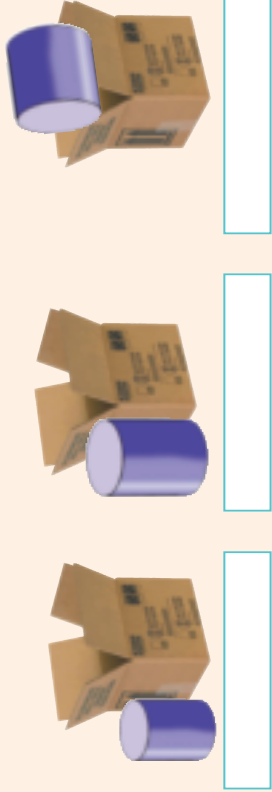

Sebenzisa amagama angezantsi ugqibezele izivakalisi

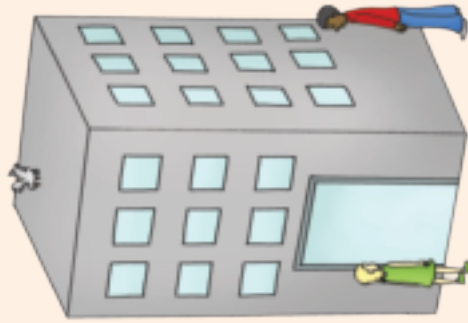

Intombazana ijonge ku _____ wesakhiwo.

Indoda ijonge kwi _____ lesakhiwo.

Intaka ijonge ku _____ wesakhiwo

cala mphezulu mphambili



Teacher: _____
Sign: _____
Date: _____

Umhla:

Ukuphinda kabini nokwahlula kubini

Usakhumbula? isi-2 sisiqingatha sesi-4 isi-4 sisi-2 esiphindwe kabini
 ama-20 sisiqingatha sama-40 ama-40 ngama-20 aphindwe kabini
 ama-200 sisiqingatha sama-400 ama-400 ngama-200 aphindwe kabini

Khumbula! Oku singakubonisa ngomfanekiso...

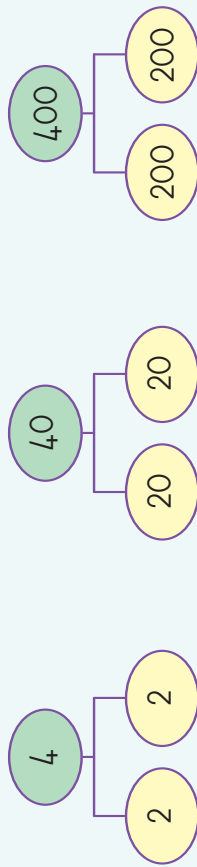

Ukufumana iziqingatha (iifafu)

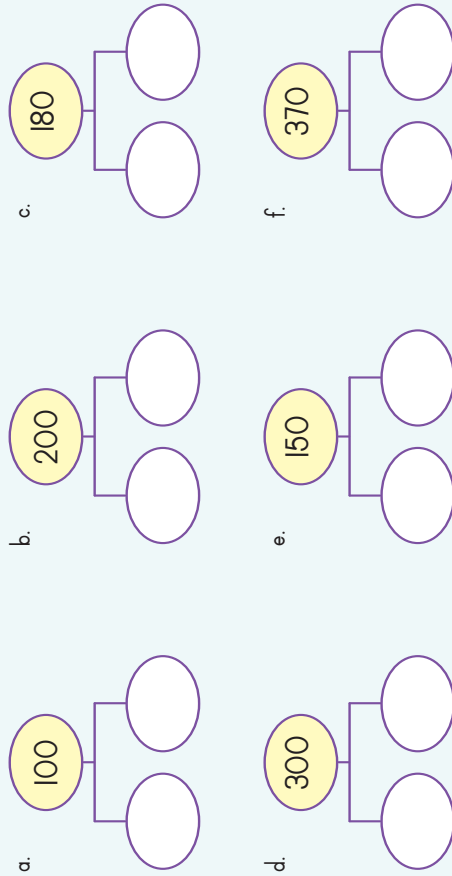

Phinda inani kabini usebenzise umgca - manani.
 Sikwenzele umzekelo wokuqala.

Umzekelo

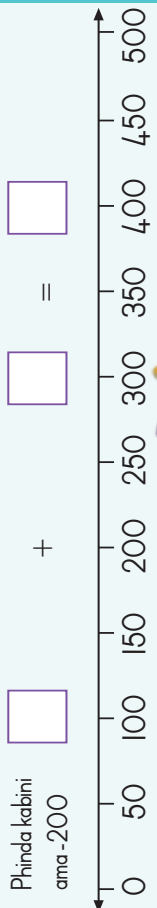
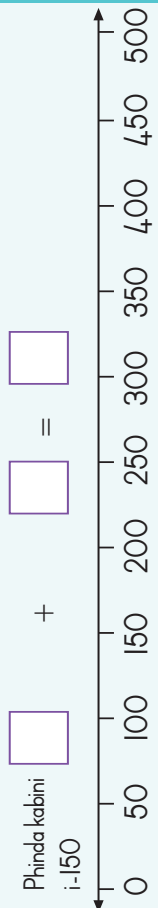
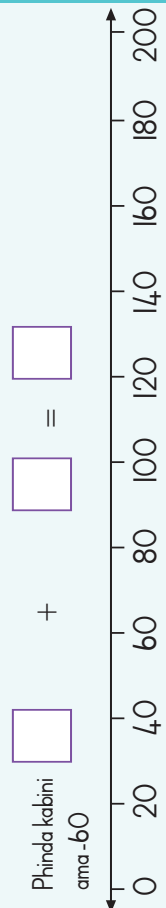
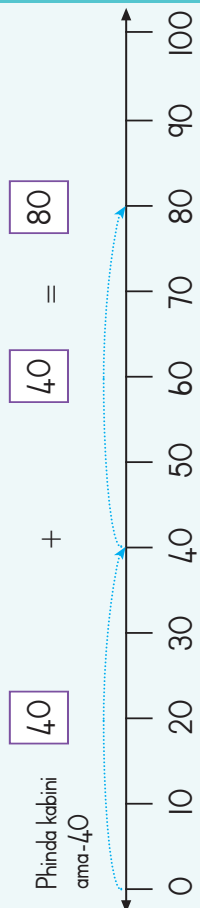

Gqibezela oku kulandelayo



Gqibezela oku kulandelayo

a. Phinda kabini -100	200
b. Phinda kabini -150	
c. Phinda kabini -120	
d. Phinda kabini -150	
e. Phinda kabini -170	

a. isiqingatha sama-220	110
b. isiqingatha se -180	
c. isiqingatha sama -260	
d. isiqingatha sama-60	
e. isiqingatha sama -320	

Teacher: _____
 Sign: _____
 Date: _____

Okunye ngokuphinda kabini nokwahlula kubini

Khangela uphindaphindo kabini okanye iziqingatha

a. b. c. d. e. f.

Gcina imali yokuthenga ibhayisekile

UNtsasa ugcina ama -R25 ngeveki ukuze athenge ibhayisekile. Kufuneka agcine imali iiveki ezingaphi?

Impendulo: iiveki

Intengiso

Zonke izinto ezithengiswayo zithengiswa ngesiqingatha sexabiso. Bhala ixabiso lentengiso kufutshane nento ethengiswayo.

a. Iingubo R190
Ixabiso lentengiso _____

b. Amashiti R154
Ixabiso lentengiso _____

c. Imiqamelo R54
Ixabiso lentengiso _____

d. Izitulo R220
Ixabiso lentengiso _____

Intengiso R450
Ixabiso elisisiqingatha: ibixabiso R900

Zirandi ezingaphi?

	R135	USenzo ufuna ihempe. Unesiqingatha sesixa kuphela. Kufuneka abe namalini ngoku? R _____
	R78.50	Izihlangu zikaSiko zibiza kabini kunezi. Zibiza malini izihlangu zikaSiko? R _____
	R97	Ilokhwe kaPhindi ixabisa kabini kuneli ixabiso. Ingaba ilokhwe kaPhindi ixabisa malini? R _____

Kungena ntoni? Kuphuma ntoni?

Landela umzekelo. Gewwalisa amanani ashicilelweyo.

a.

b.

Umhla:



Qukanisa uze udibanise



Qukanisa abantwana

UNkosikazi Ndaba ufuna ukwahlula ikhosi ibe ngamaqela alinganayo aza kudlala imidlalo yqhandle. Okokuqala ubahlula babe ngamaqela ama-4.



- a. Bala abantwana.
- b. Wenza amaqela amangaphi?
- b. Bonisa zonke ezinye iindlela ulNkosikazi Ndaba anokuzisebenzisa ukwenza amaqela abantwana.

Qaphela, Thelekisa.

Blank lines for writing answers to question b.

Zingaphi iimpahla?

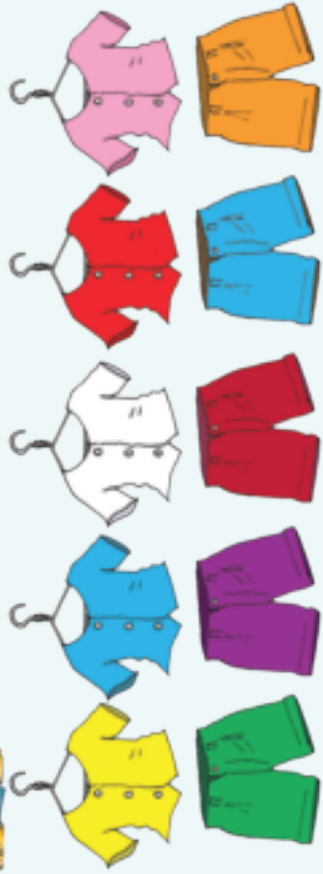

UPhindi uneehempe ezi-5 ezimibalbala neebhulukhwe ezimfutshane ezimibalbala ezi-5. Zingaphi iimpahla ezahlukeneyo anokuzenza edibanisa imibala eyahlukeneyo?

Umzekelo: Ithempe ezuba/ibhulukhwe emfutshane ezuba. Ithempe ezuba/ibhulukhwe emfutshane eorenji.

Bhala unobumba wokuqala wombala ngamnye. Bonisa zonke ezinye iimpahla ezinokwenziwa.

Blank lines for drawing and writing colors for the clothing items.

Thelelela: Bekunokwenzeka ntoni xa uPhindi ebenembala emi -b eyahlukeneyo yeehempe neebhulukhwe ezimfutshane? Zingaphi iimpahla anokuzenza?

Qaphela, Thelekisa. Lungisa.

Teacher Sign: _____ Date: _____



Umhla:

Ukonwaba ngezibalo



Khangela umthetho

Sebenzisa umthetho ukuze ufumane amanani angekhoyo.

Yenza oku

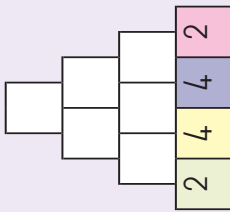
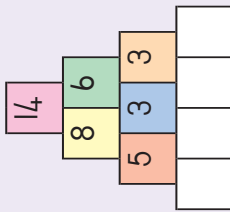
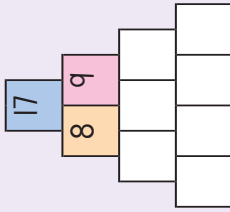
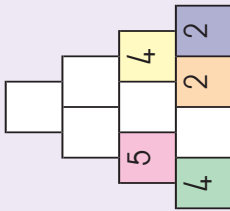

Yakha ama-20 ngeendlela ezi-3 ezahlukeneyo

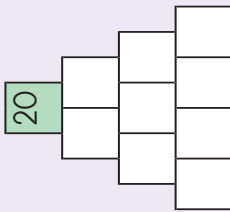
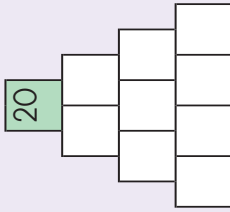
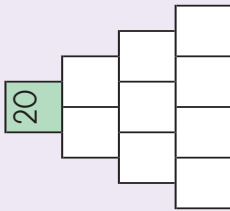

Umngeni

Khawucinge!



Sebenzisa amanani 1, 2, 3, 4, no-5.

Amanani amathathu kumqolo ngamnye kufuneka enze i-10 xa edibene.

Umthetho: Sebenzisa inani ngalinye kube kanjye kuphela.

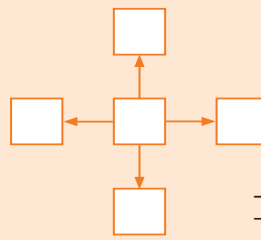

Khangela amanani



a. Umthetho: Amanani akumqolo ngamnye kufuneka anike isiphumo esili -1b edibene.

2	5	3	6
			2
		2	

b. Umthetho: Amanani ama-3 kwinqolo exwesileyo nakwiikholamu ezihlayo mawanike isiphumo esifanayo xa edibene.

2	7	6
9		1
	3	8

23	28	21
12		26
		10

c. Umthetho: Fakela nokuba ngawaphi amanani ama-5 athi xa edityanisiwe anike inani elisebindini wenkwenzezi.

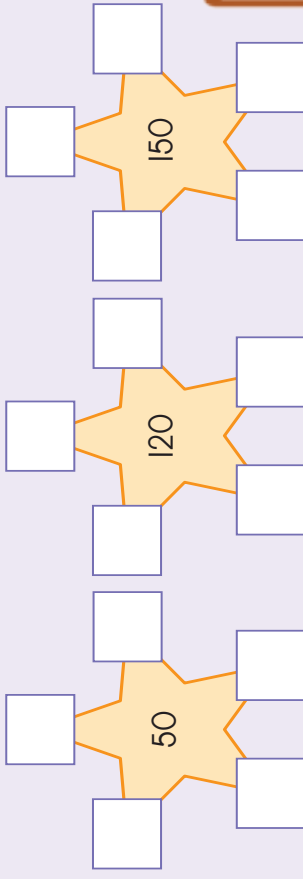

Teacher: _____
Sign: _____
Date: _____

1	1	0	1	0	0
2	2	0	2	0	0
3	3	0	3	0	0
4	4	0	4	0	0
5	5	0	5	0	0
6	6	0	6	0	0
7	7	0	7	0	0
8	8	0	8	0	0
9	9	0	9	0	0

