

Revised and  
CAPS aligned

# Grade R



Name: \_\_\_\_\_



ENGLISH  
GRADE R – BOOK 1  
TERM 1  
ISBN 978-1-4315-0689-7  
THIS BOOK MAY NOT BE SOLD.  
14th Edition



basic education  
Department:  
Basic Education  
REPUBLIC OF SOUTH AFRICA

ENGLISH

Book



Term 1



Mrs Angie Motshekga,  
Minister of  
Basic Education



Dr Reginah Mhaule,  
Deputy Minister of  
Basic Education

These Reception year (Grade R) Rainbow Workbooks form part of the Department of Basic Education's strategy to boost South African children's school performance. Research shows that for every year that children are exposed to stimulating activities before Grade 1, they perform better academically in later years – throughout their primary and secondary schooling. Hence this strong focus on learning in Grade R.

The Foundation Phase curriculum requires that Grade R learners are given the opportunity to develop their pre-reading, pre-writing and pre-mathematics skills and outlines the skills they will need to get a solid educational foundation so that they find it easier to learn in Grade 1 and beyond.

The Grade R workbooks therefore aim to assist children in developing these skills and the key initial concepts they need to lay a solid foundation for learning. They are packed with opportunities for children to develop and practise the skills that will prepare them for formal schooling.

Before children formally learn to read they need to find out how to hold a book and turn its pages, and to understand how books work. They need to understand the relationship between the words and pictures in a book and to realise that words on a page are made up of sounds and have meaning. Similarly, before children learn to write, they need to develop their fine motor coordination, to practise the formation of shapes and then to move on to forming letters. These are precisely the skills that these workbooks aim to develop.

We know that all children do not learn at the same pace the Grade R workbooks make it possible for teachers to work at the learner's individual pace and, where necessary, to go backwards and forwards in the book, in line with each child's unique development. The activities will also assist teachers in identifying barriers that children may have in learning so that these can be addressed before the child starts formal schooling.

The workbooks integrate the teaching of literacy, numeracy and life skills across 20 themes using fun and engaging ways to capture young learners' interest and attention. We hope that your learners will enjoy working through the workbook activities as they grow and learn, and that you, as their teacher, will share in their pleasure.

## Teamwork



### Building a puzzle...



basic education  
Department:  
Basic Education  
REPUBLIC OF SOUTH AFRICA



SCAN HERE  
or visit [OMO.CO.ZA](http://OMO.CO.ZA)  
for fun activities in  
the OMO Messy  
Play Zone.



# Grade R

## INTEGRATED

- Home Language
- Mathematics
- Life Skills

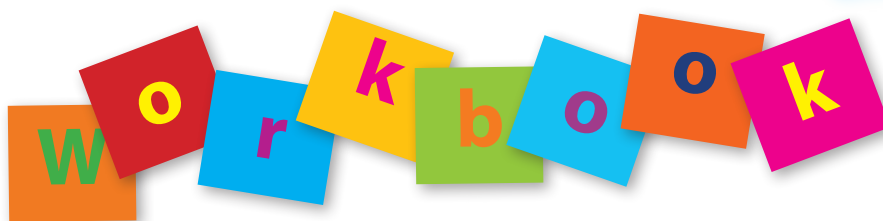

1	About Me.....	2
2	My body.....	12
3	My classroom.....	24
4	Healthy living.....	32
5	Friends.....	42

ENGLISH

Book



Term 1



# About Me



Trace and colour.

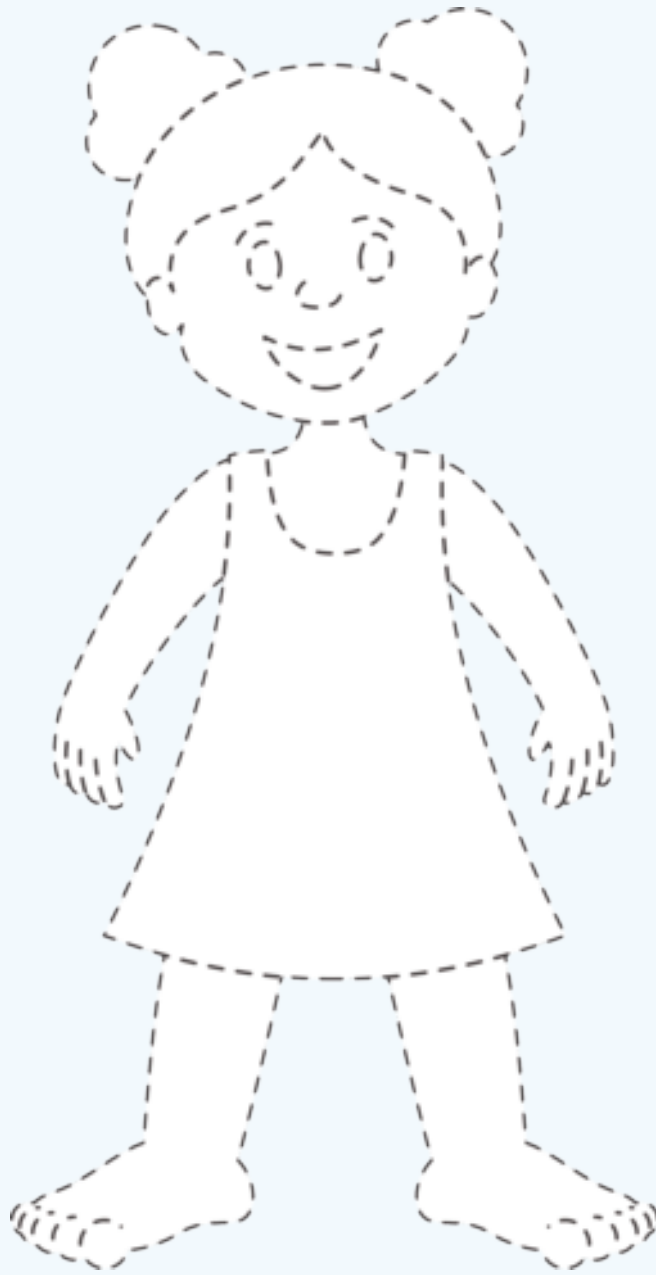

I am a

girl.



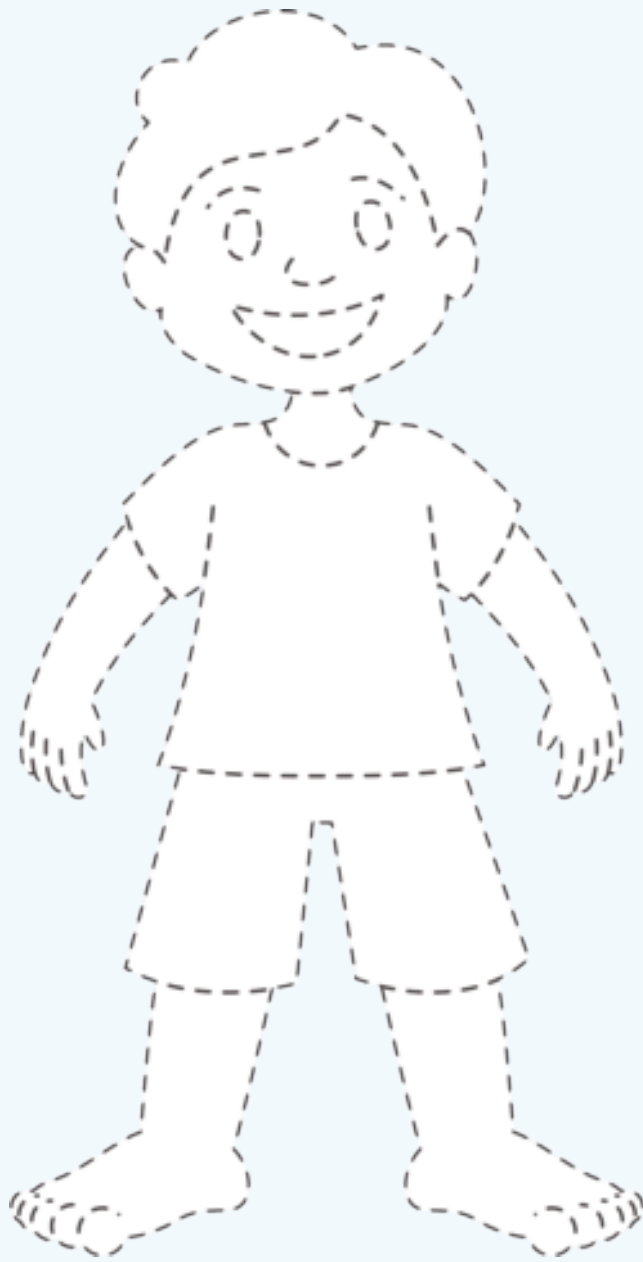

I am a

boy.

TEACHER: Sign

Date





Draw a picture of yourself.



1.2



How old are you?

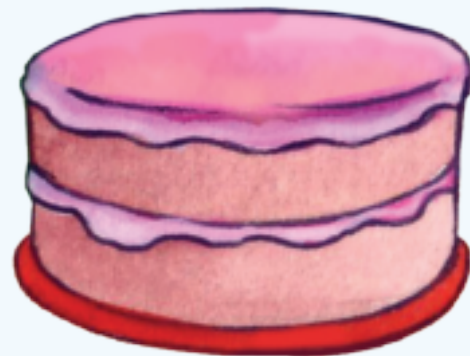
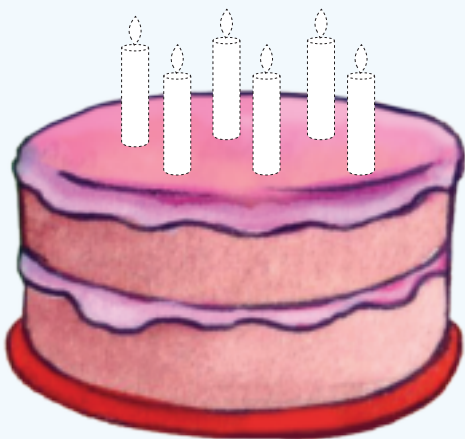

TEACHER: Sign  Date



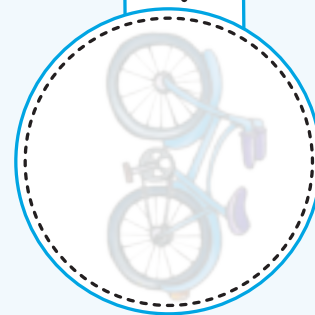
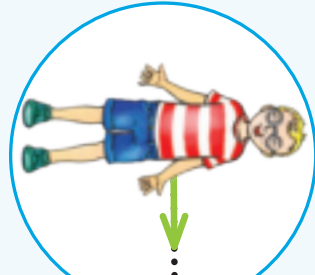
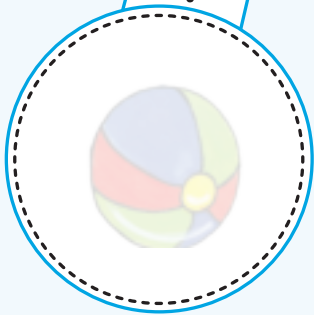

Paste the correct stickers and trace the path with your finger and then with a crayon.



Tick ✓ the box to show.

## The colour of my eyes

<input type="checkbox"/>			<input type="checkbox"/>		
		<input type="checkbox"/>			
			<input type="checkbox"/>		

## The colour of my hair

	<input type="checkbox"/>	<input type="checkbox"/>	<input type="checkbox"/>	<input type="checkbox"/>	
	<input type="checkbox"/>		<input type="checkbox"/>		

TEACHER: Sign  Date





15



Draw your face.

Term 1 – Week 1–5



8





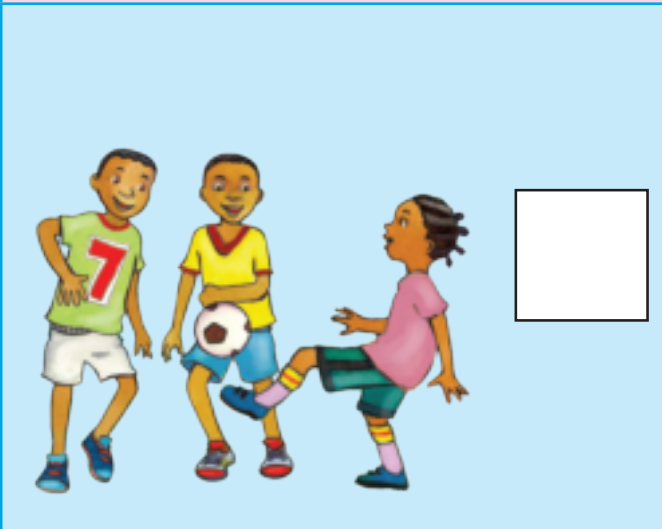
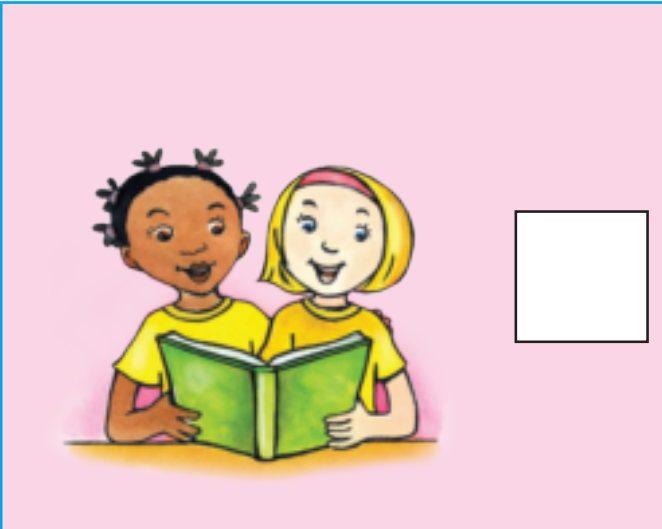
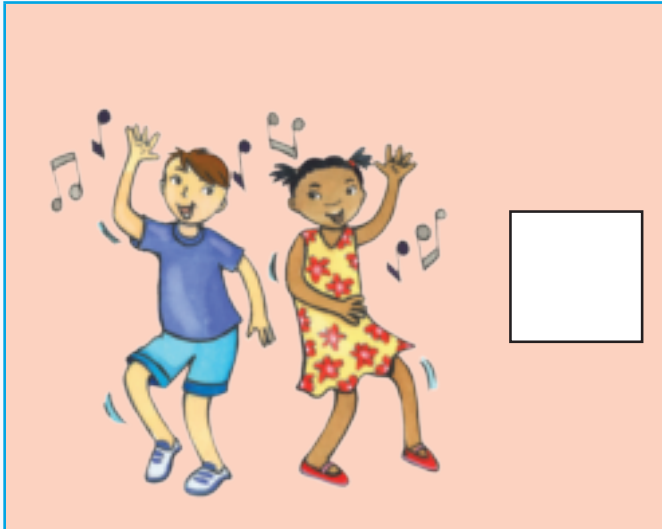

Talk about the pictures and say what you like to do.



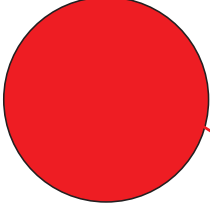







Let's match.

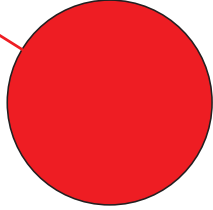





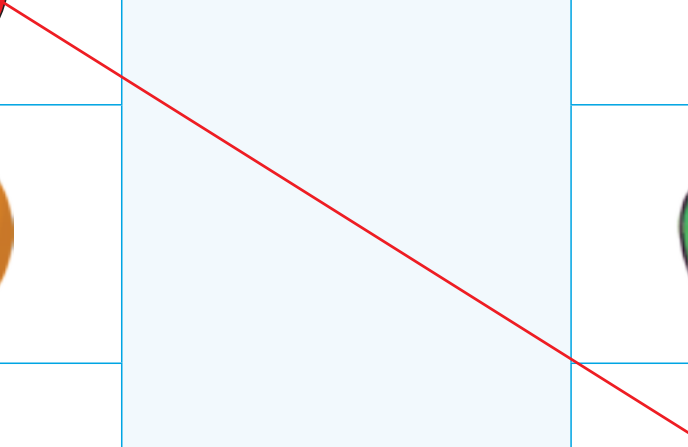



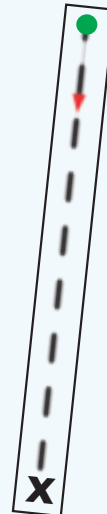
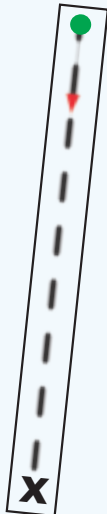

Circle the boxes that have only 1 object and trace I.

TEACHER: Sign  Date





# My body



Let's discuss and paste the missing parts.

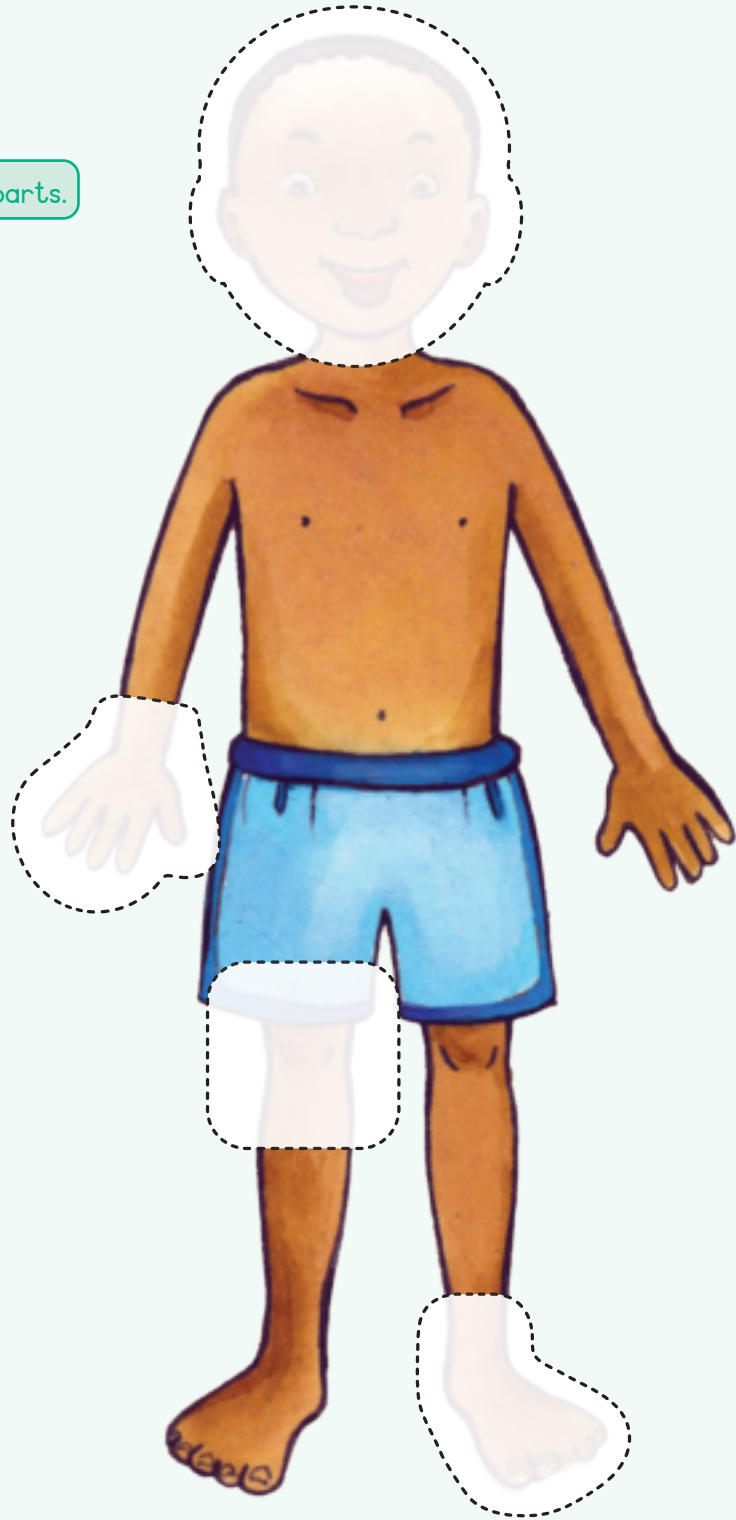

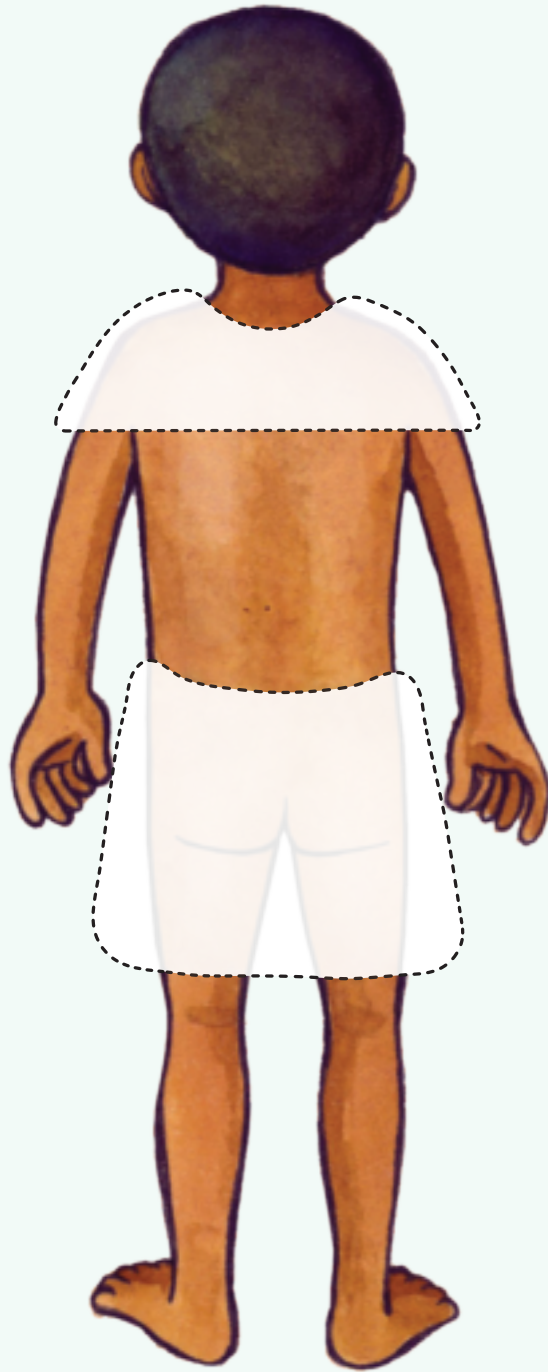

TEACHER: Sign  Date



2.



Match, trace, and colour.

Term 1 – Week 1–5

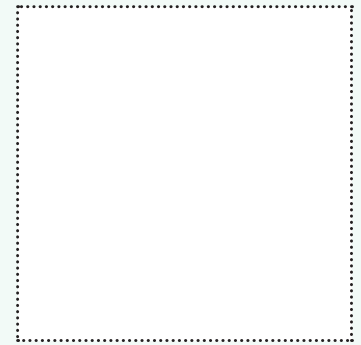
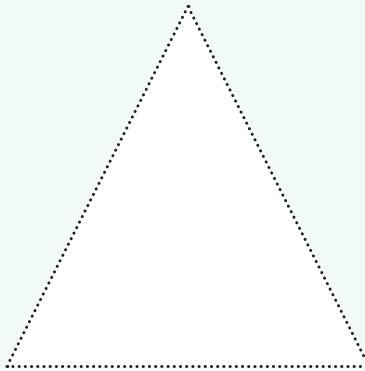
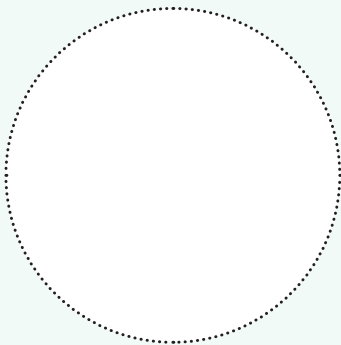
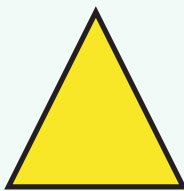
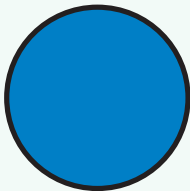
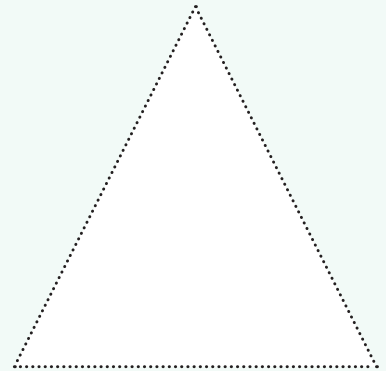
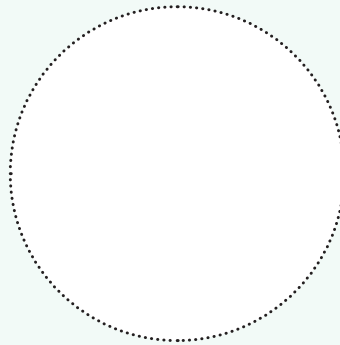
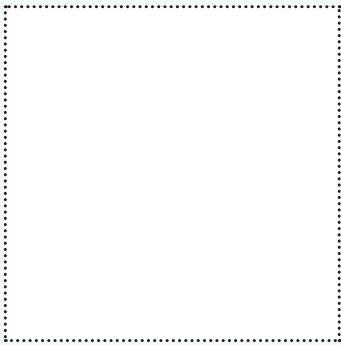
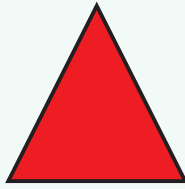
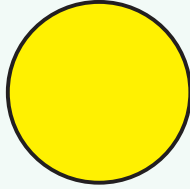
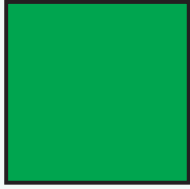

2.2



Let's fold.

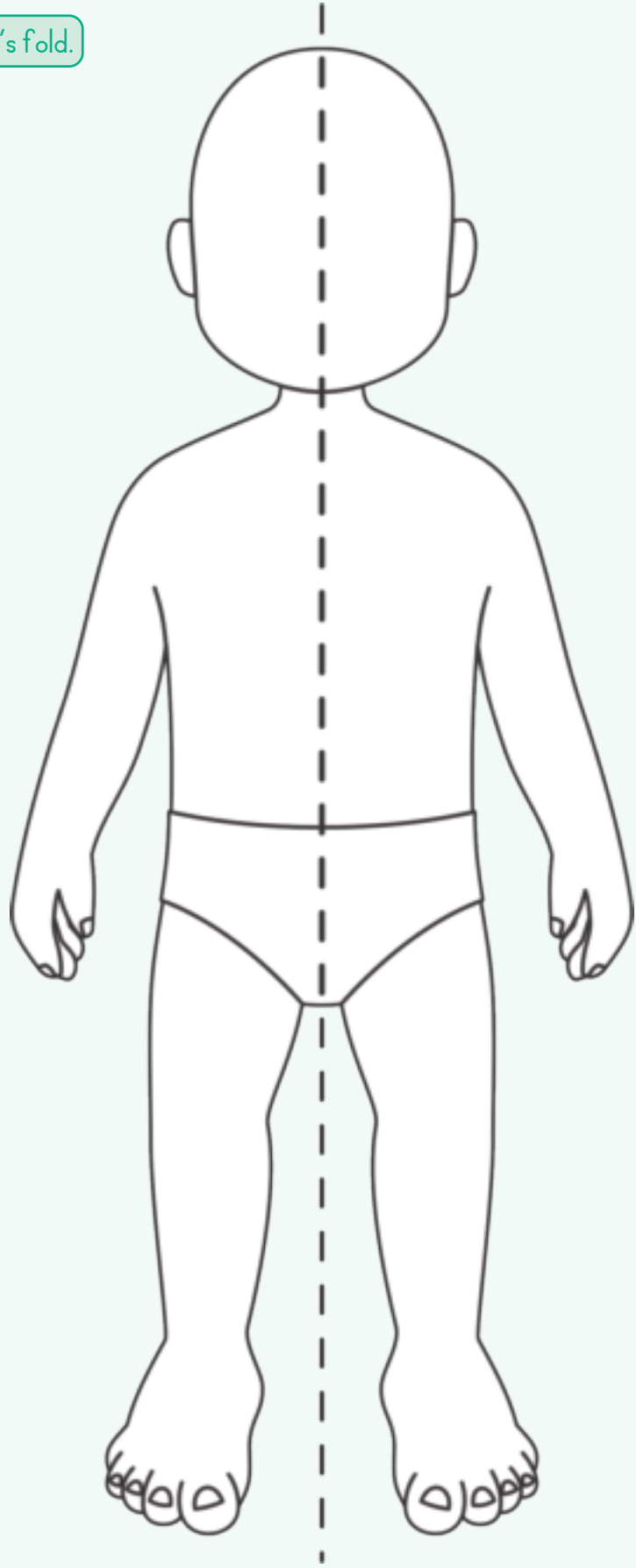

TEACHER: Sign  Date



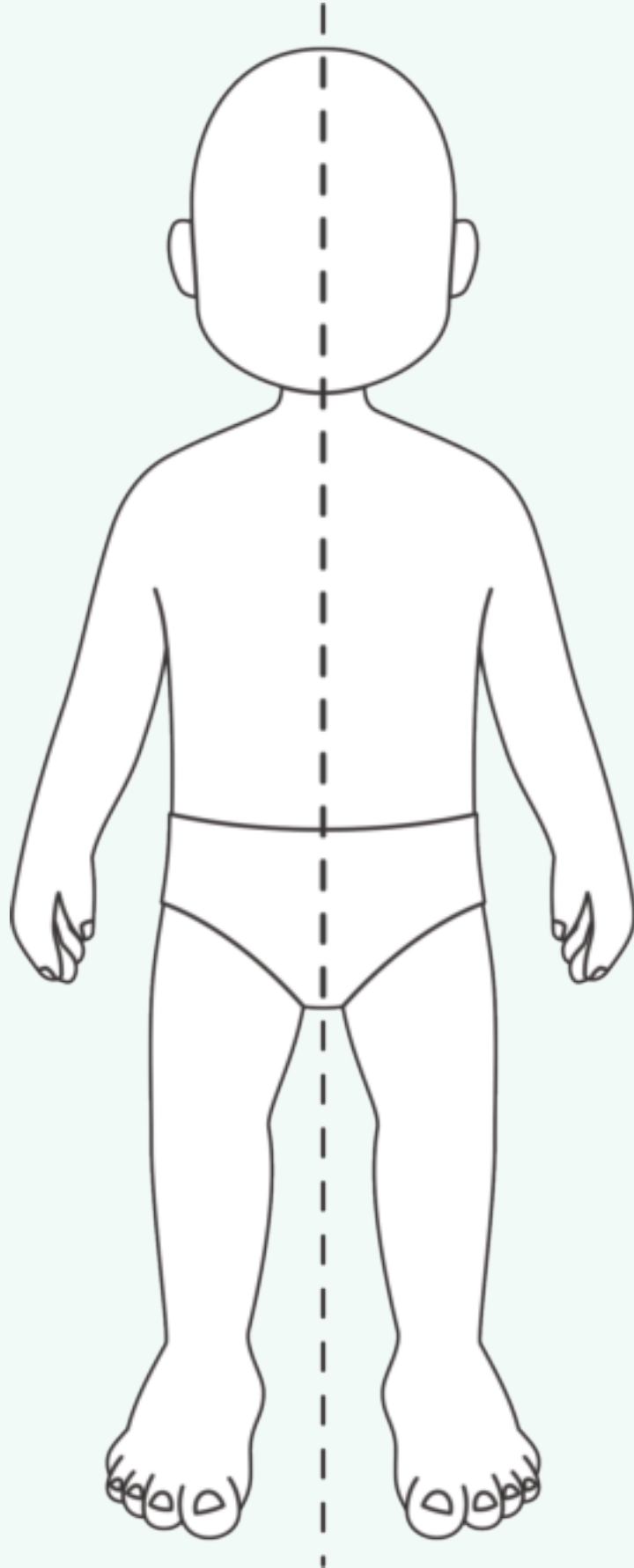

2.3



Cut and paste correctly.

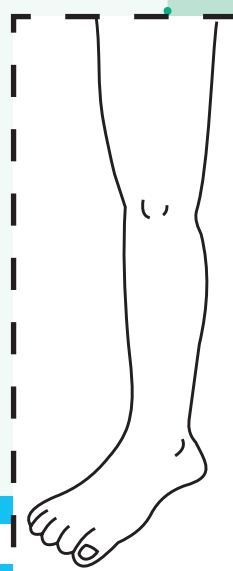
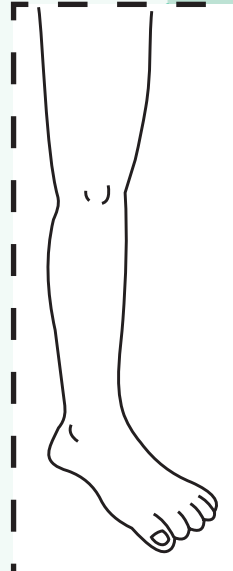
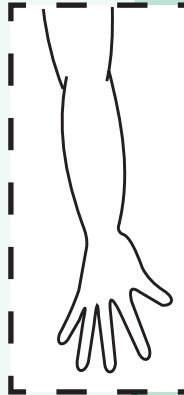
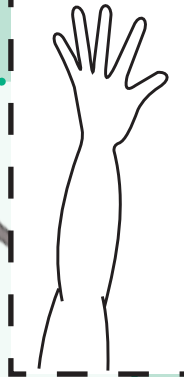
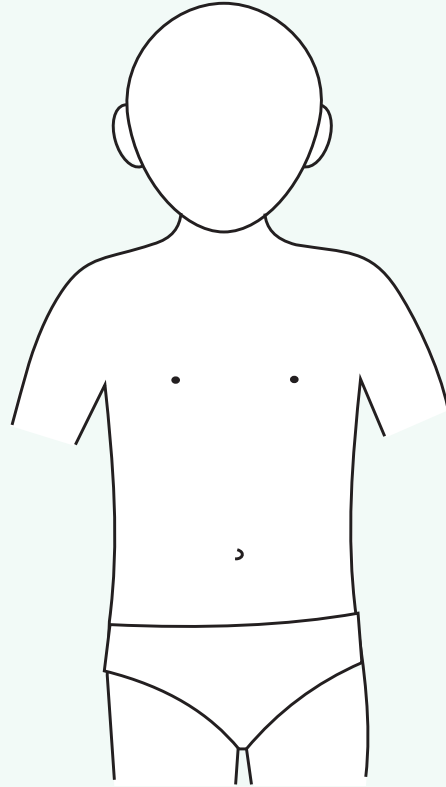

TEACHER: Sign  Date



2.4



Trace your left/ right hand.

Large empty rounded rectangular box for tracing the left and right hands.



Do your fingerprints.



Five empty rounded rectangular boxes for drawing fingerprints.



TEACHER: Sign  Date



Sequence the activities done in the morning.





Circle the odd one in each row.

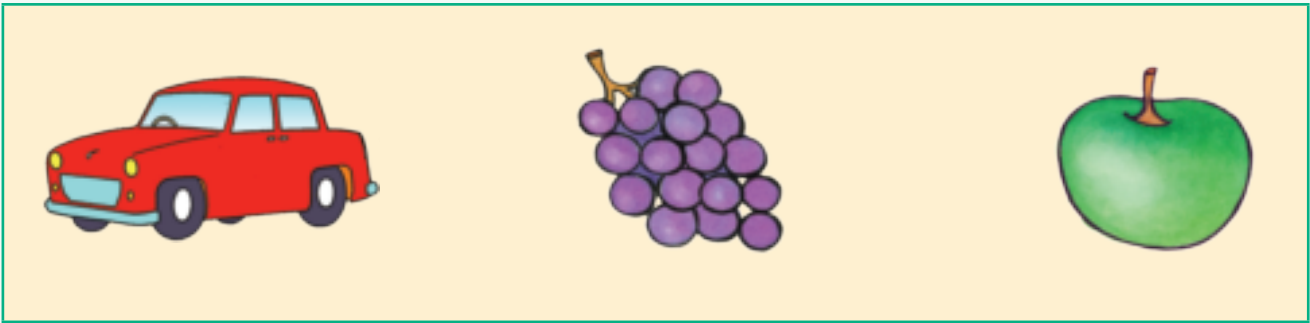
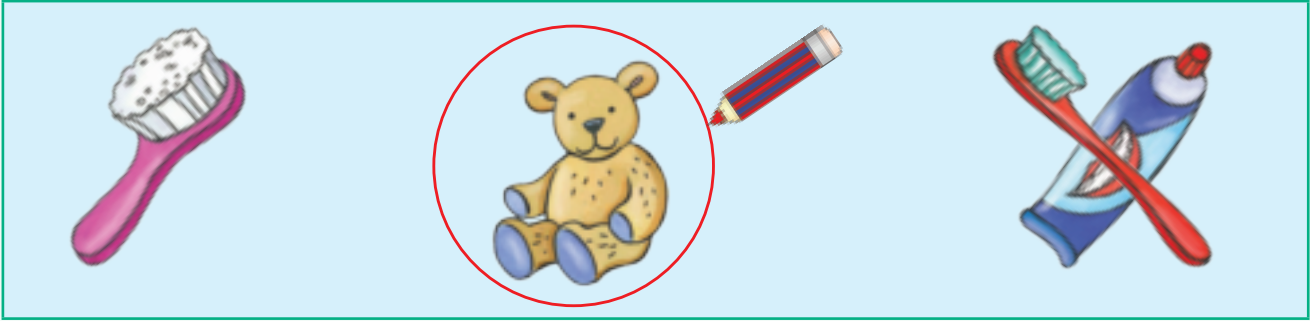



Which face matches the first in each row?





Repeat the pattern.

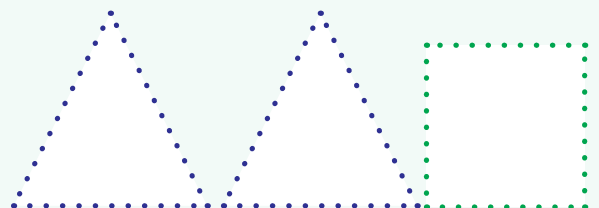
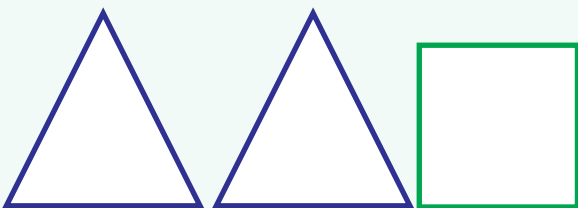
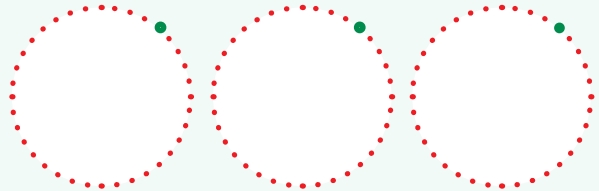
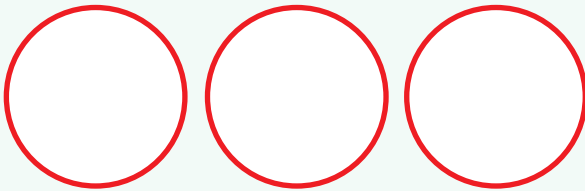
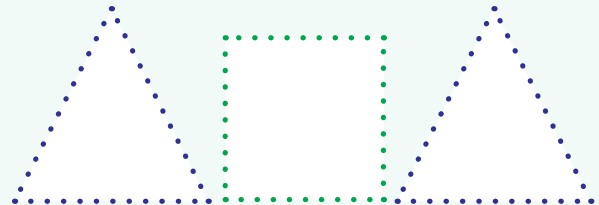
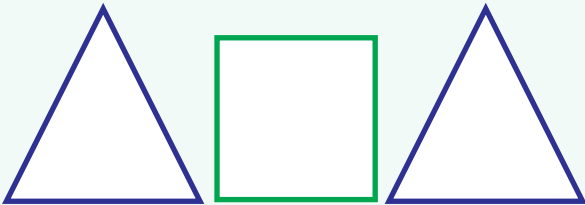
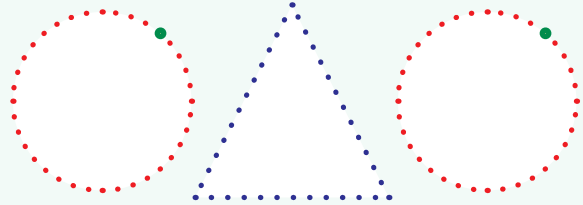
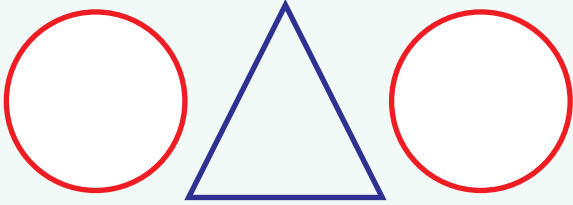

TEACHER: Sign  Date

# My classroom

Discuss the picture.





TEACHER: Sign  Date



Trace the strings, tick ✓ the longest and circle the shortest.

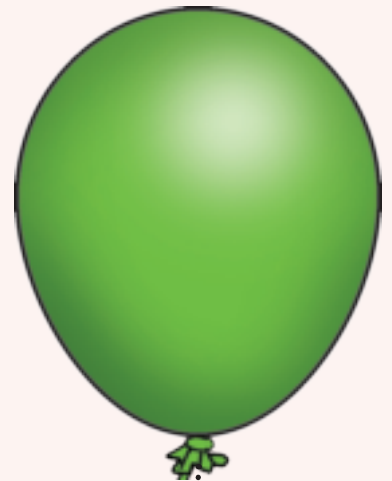
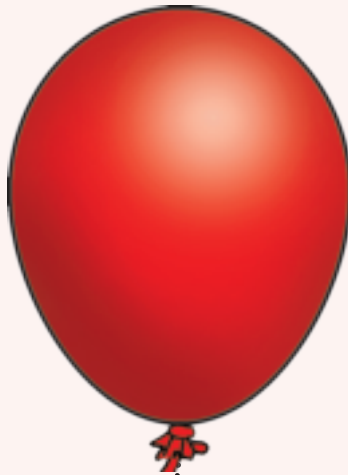
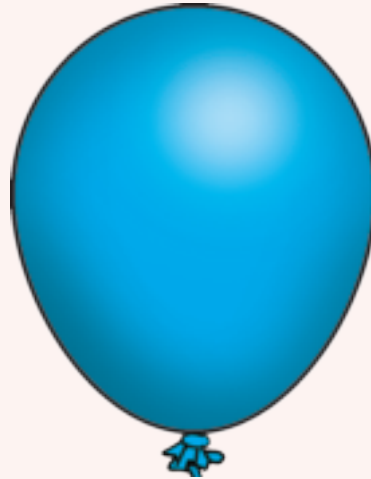
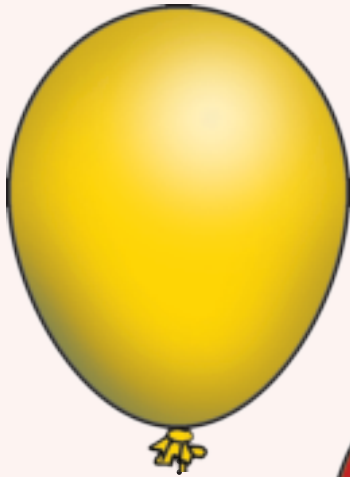



Circle the boxes with two objects only. Trace number 2.

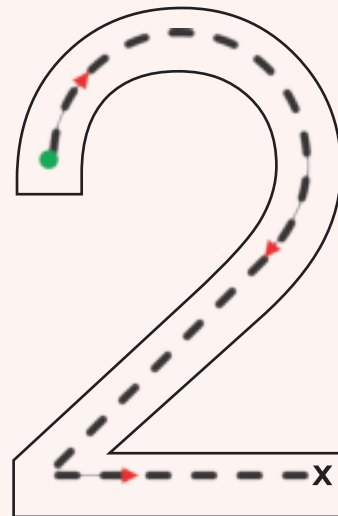
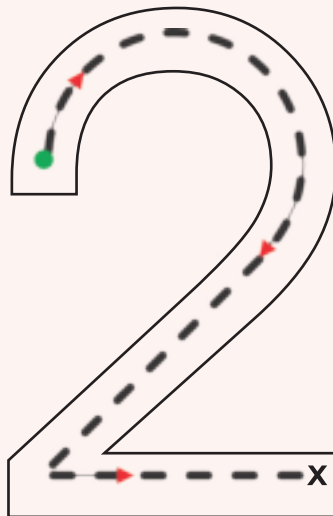
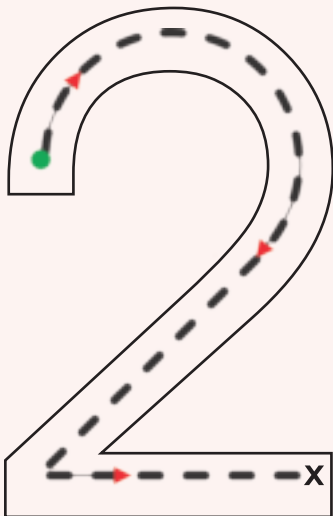

TEACHER: Sign  Date





Colour 2 objects in each row.

Term 1 – Week 1–5

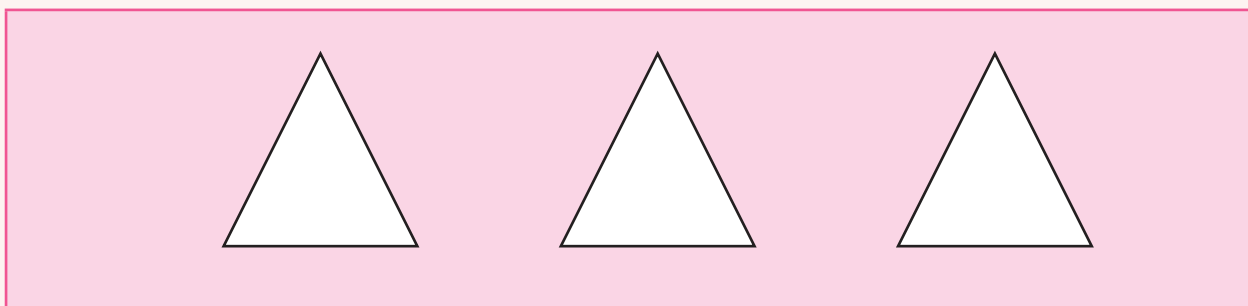
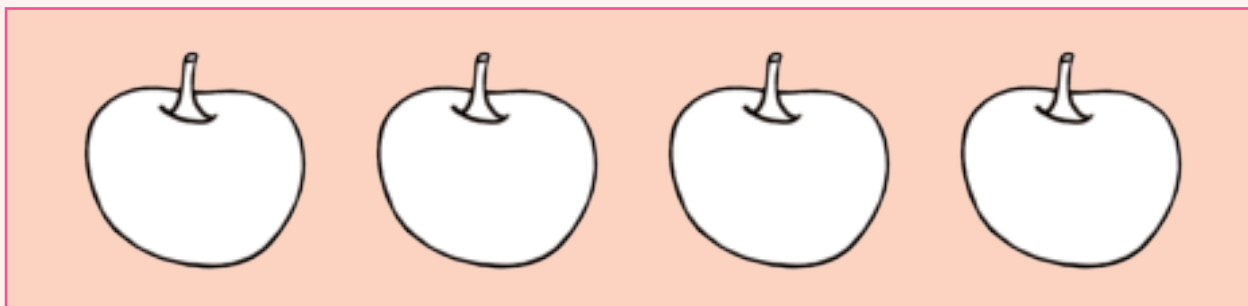



Talk about daily routine at school.





Paste the items in your school bag.





Paste the correct stickers and trace the path with your finger and then with a crayon.

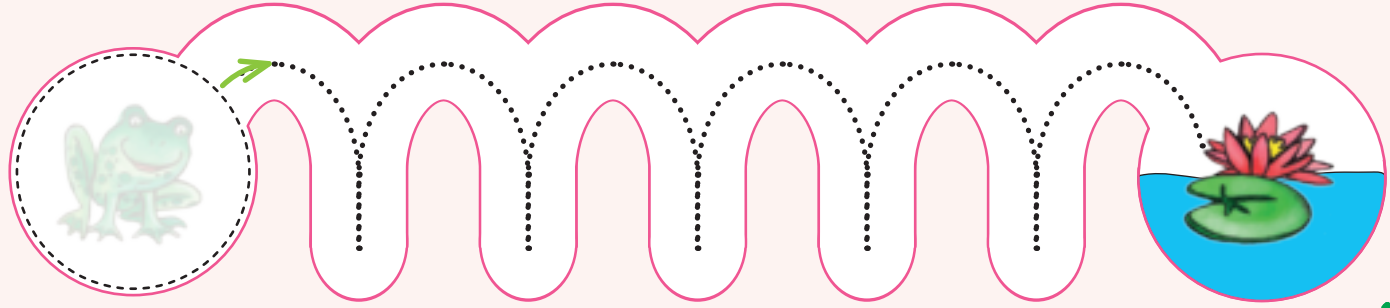
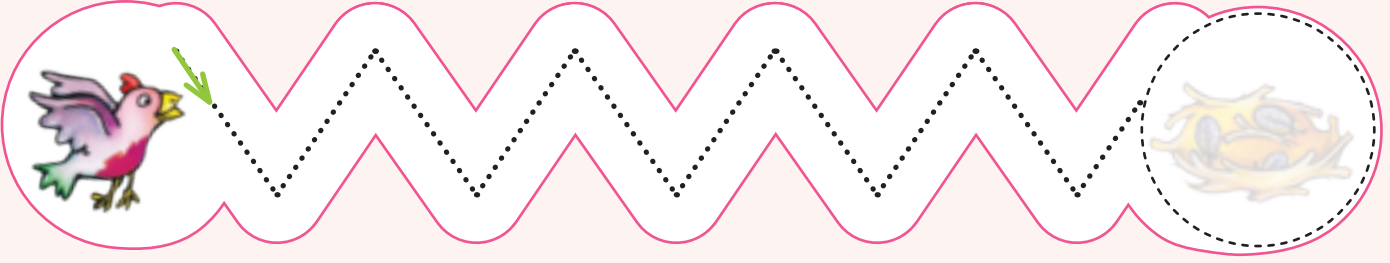
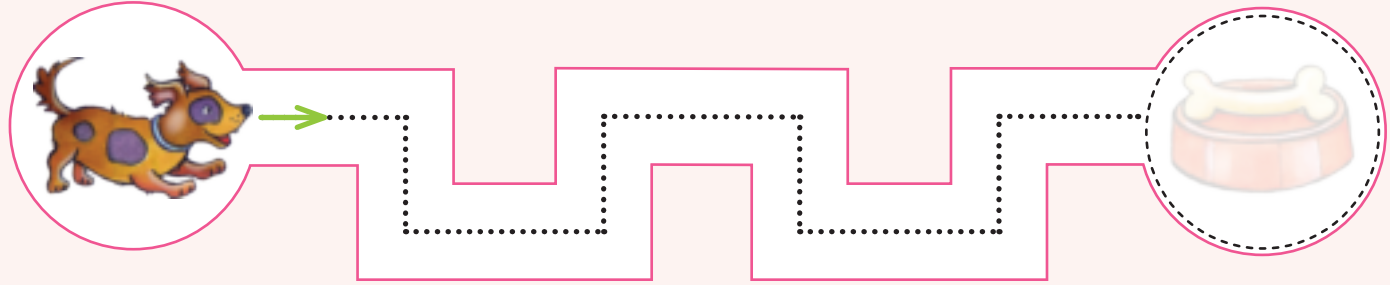
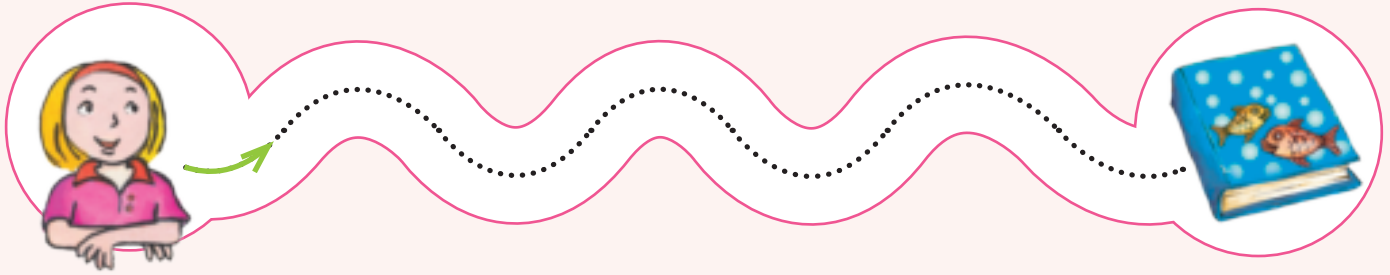



# Healthy living



Discuss the picture.





TEACHER: Sign  Date



Match and trace the path for each activity.

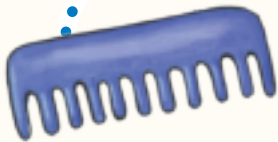

4.2



Trace and colour the tube of tooth paste and toothbrush.

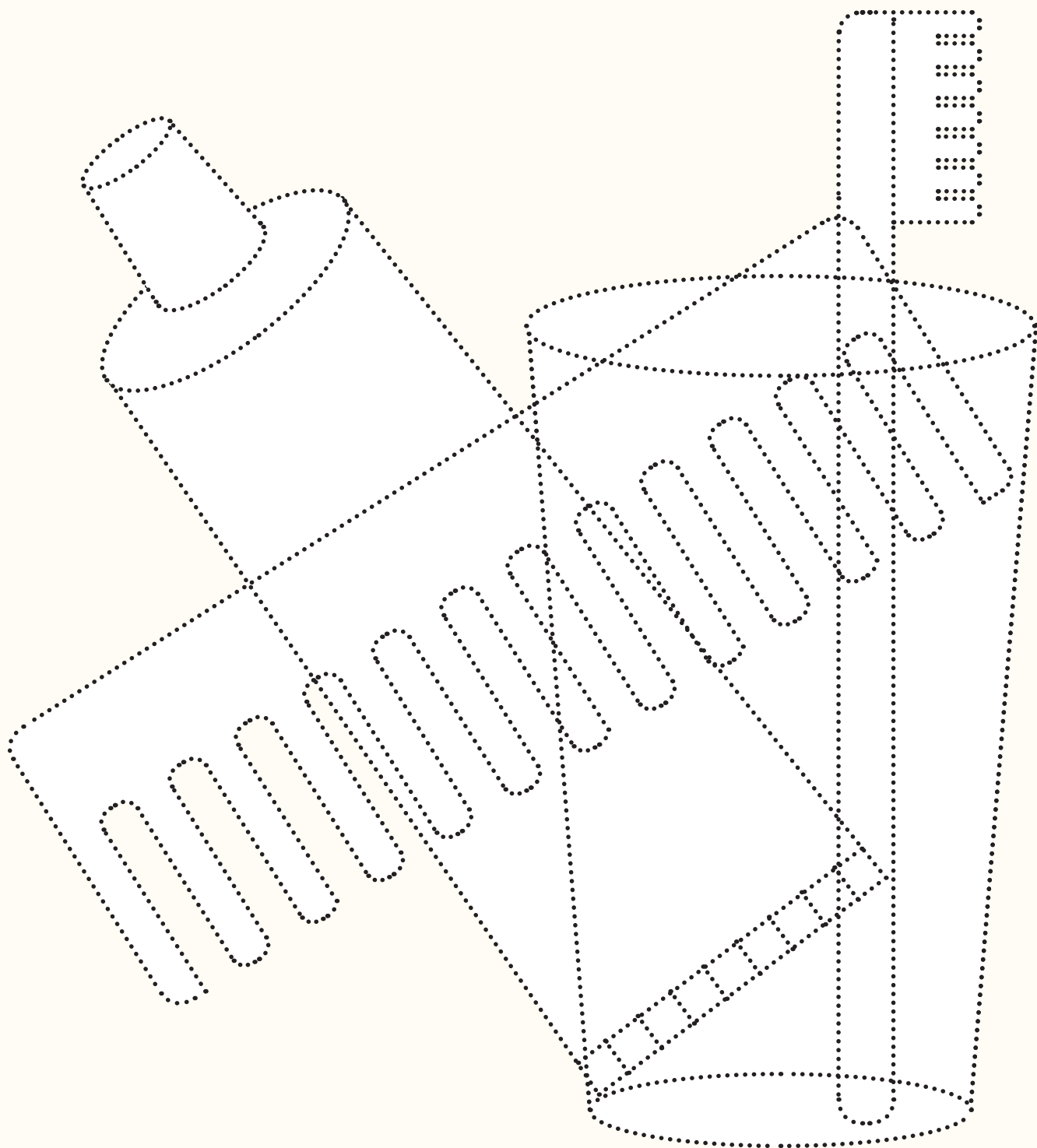

TEACHER: Sign  Date





Circle the boxes that have 3 objects only. Trace number 3.

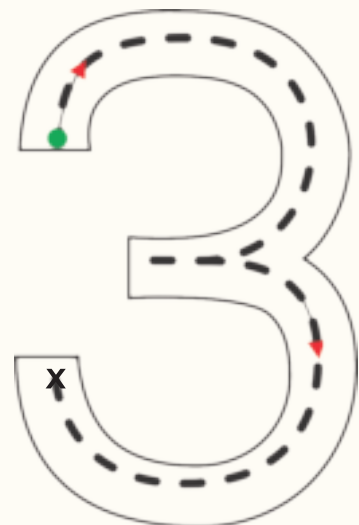
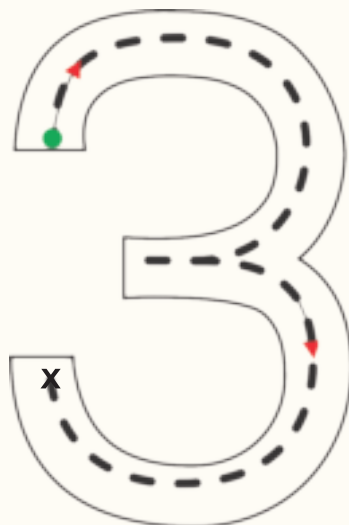
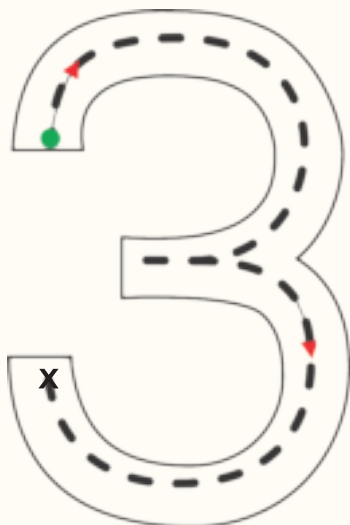
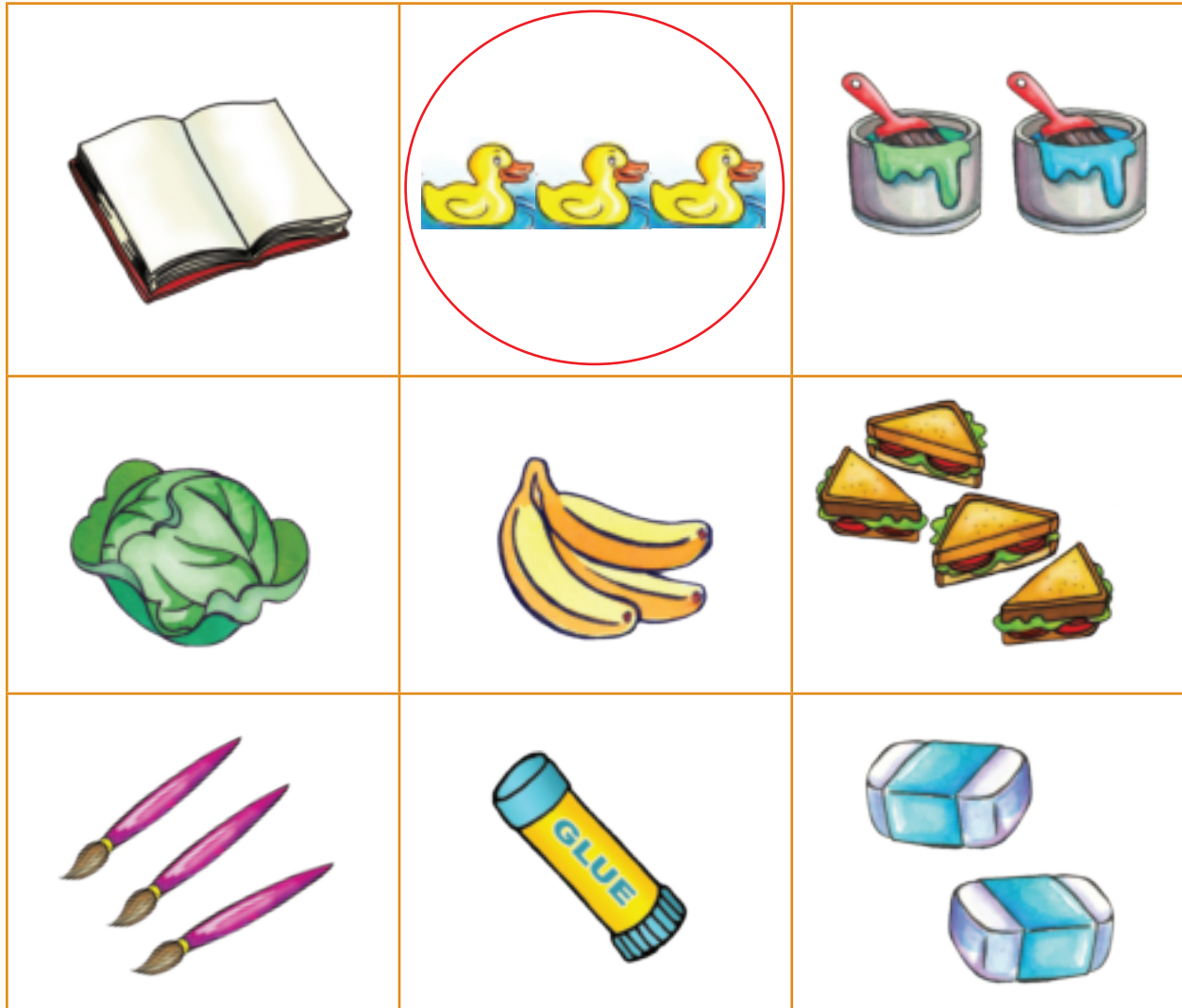

4.4



Cut on the broken lines and build your puzzle.

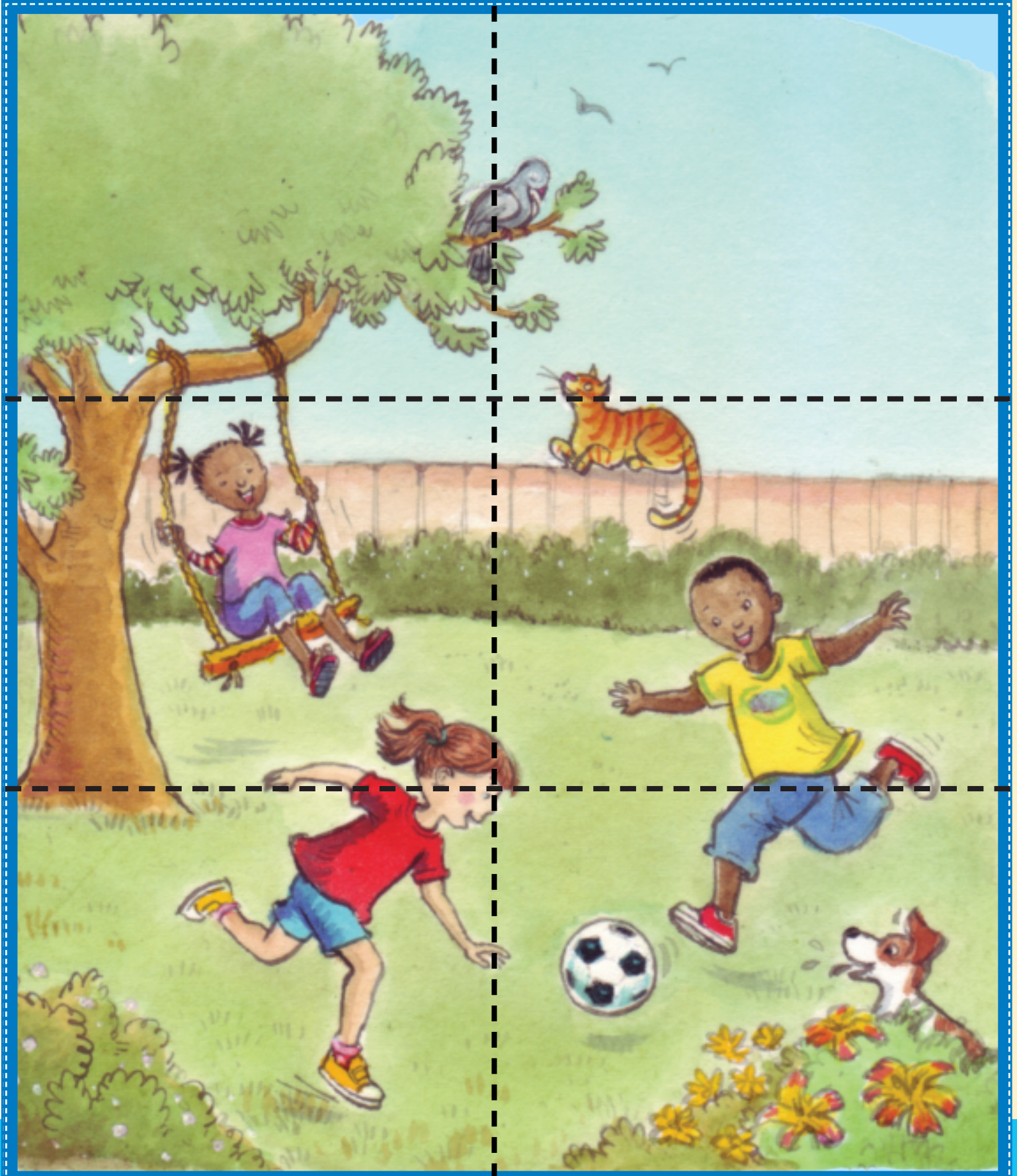

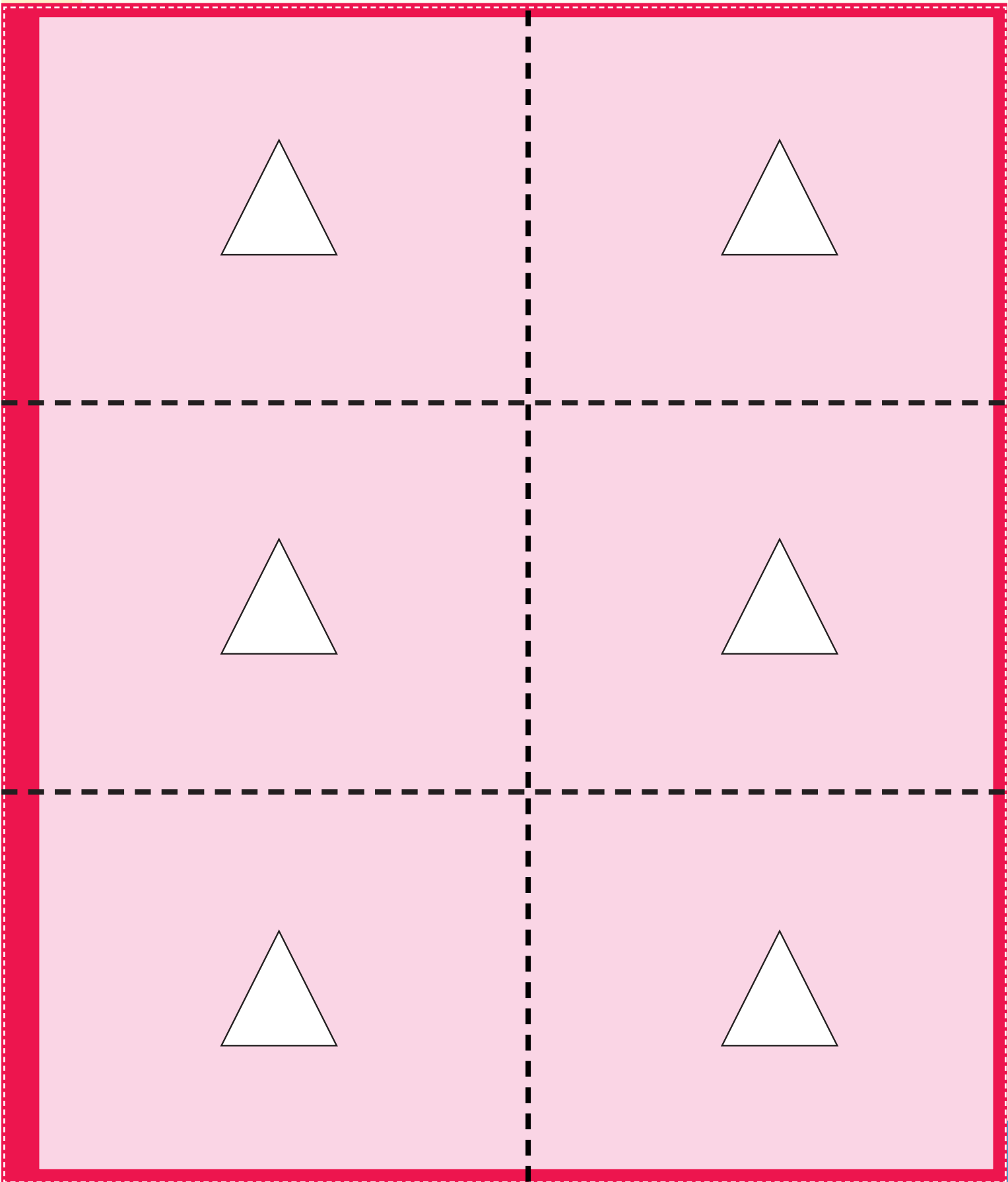
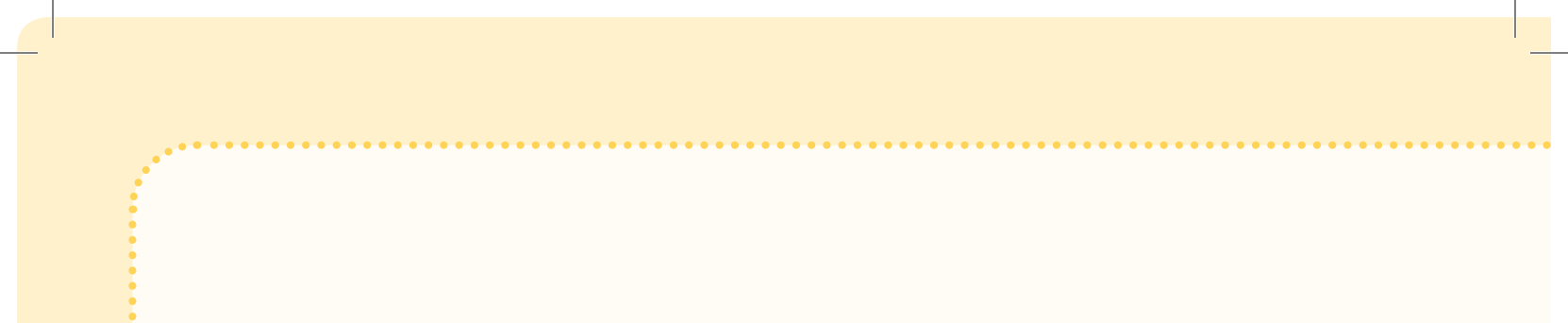



Cut on the broken lines, sequence the pictures.

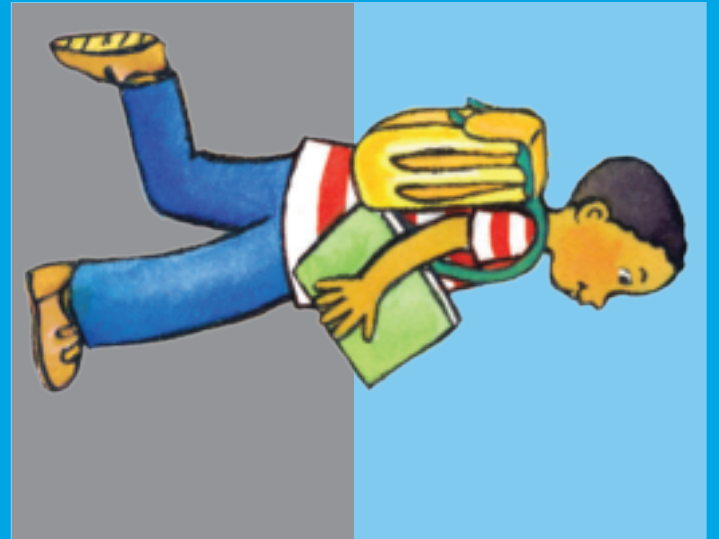
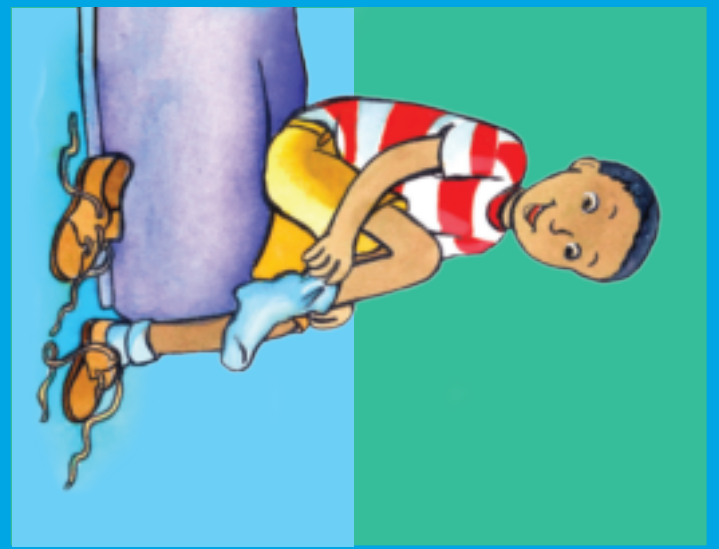

3

2

1

3

2

1

4.6

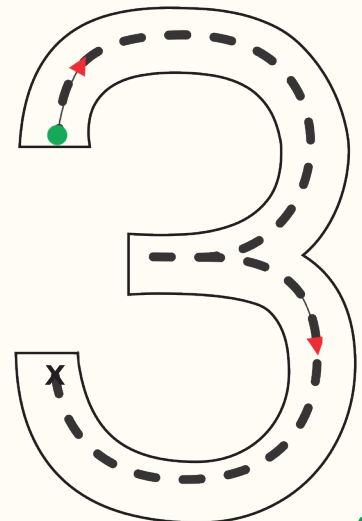
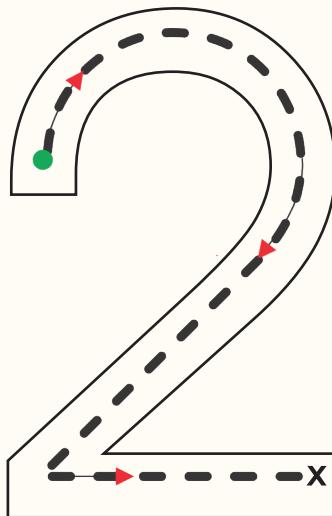
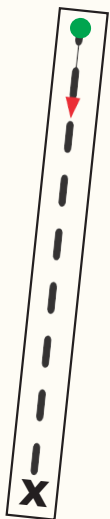

Count, paste the stickers. Trace the numbers.

TEACHER: Sign  Date



5

# Friends

Discuss the picture and paste the stickers correctly.





TEACHER: Sign  Date





Circle the identical item as in the first box.





Spot the differences in the bottom picture.



TEACHER: Sign  Date





Match and trace the item to the correct child.

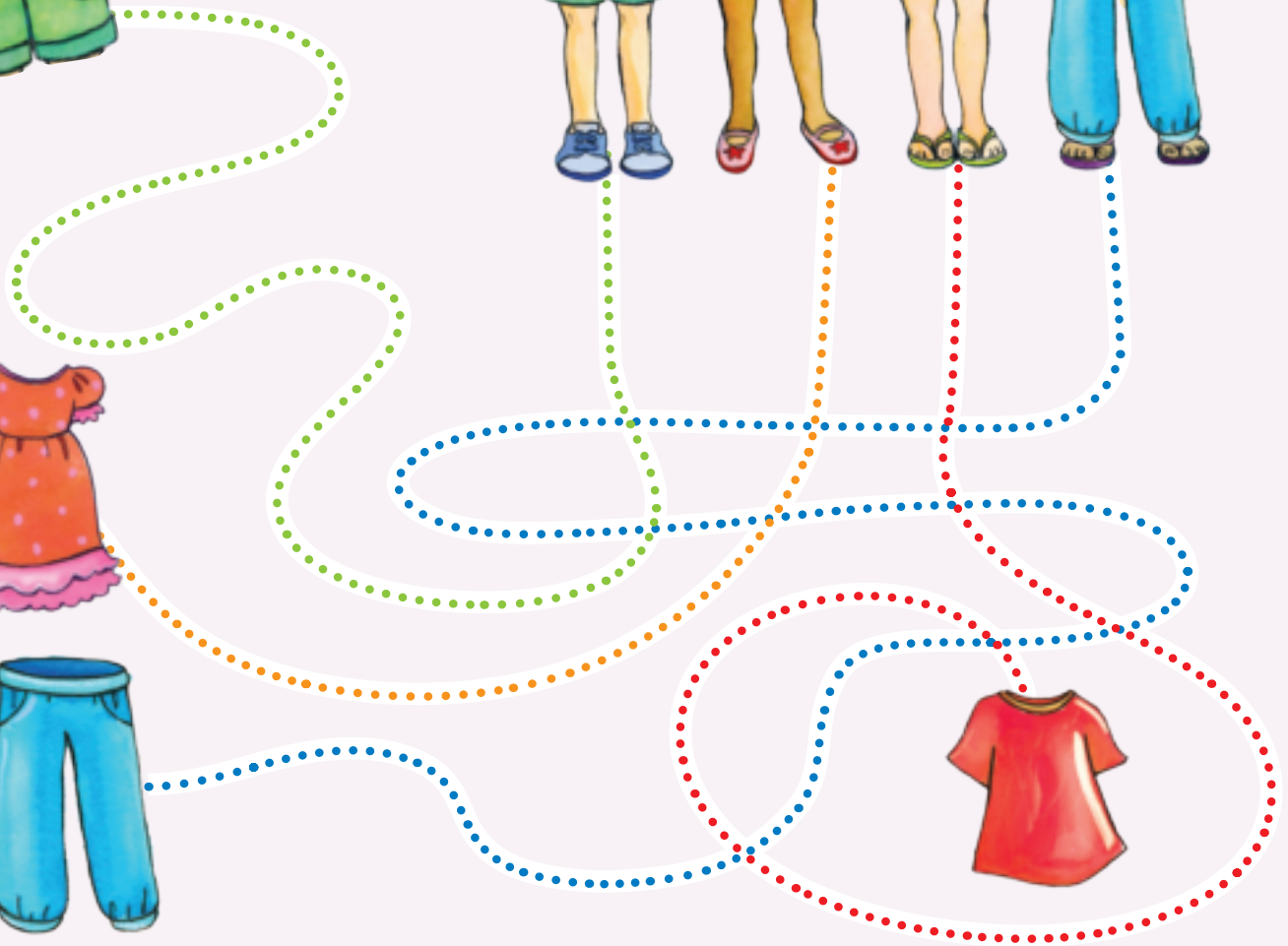



Discuss, colour, paste the stickers and count.



TEACHER: Sign  Date





Circle all the summer pictures.



5.6



Discuss the picture and paste the stickers.

hot

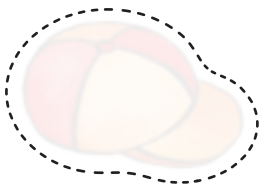
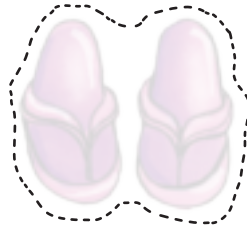
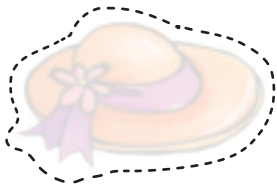

TEACHER: Sign  Date





Discuss the picture and paste the stickers.



cold

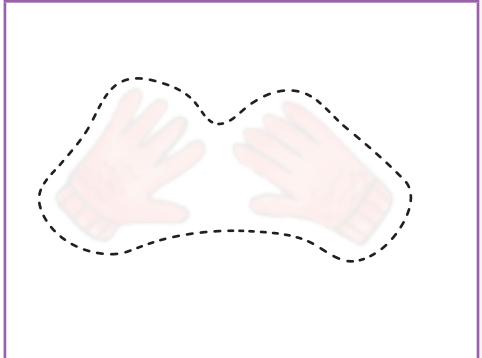
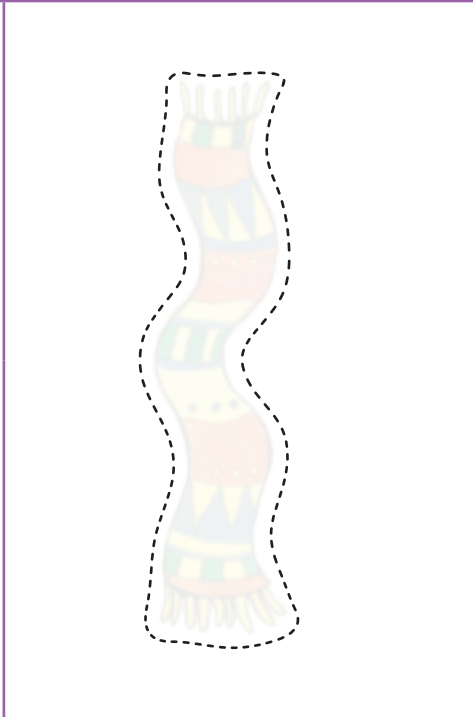



Cut and paste the arrows to help the friends reach the jungle gym.

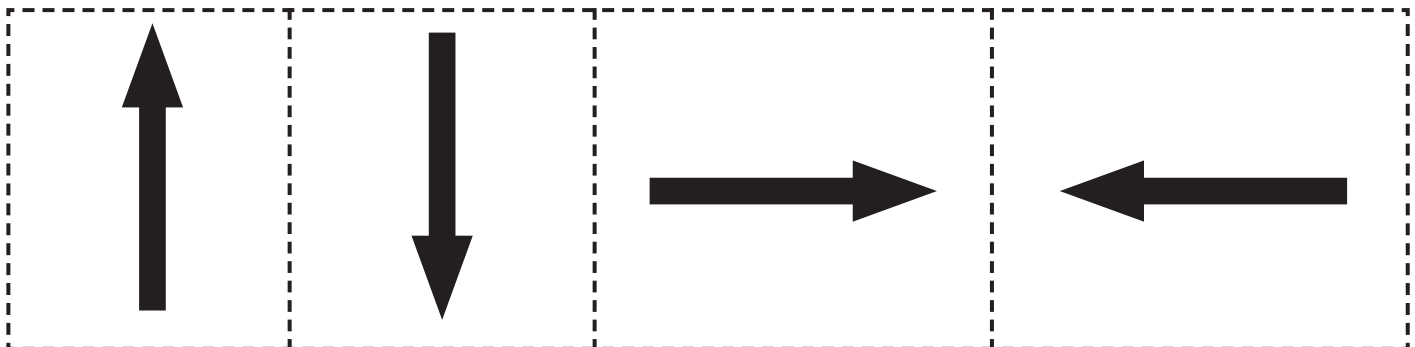
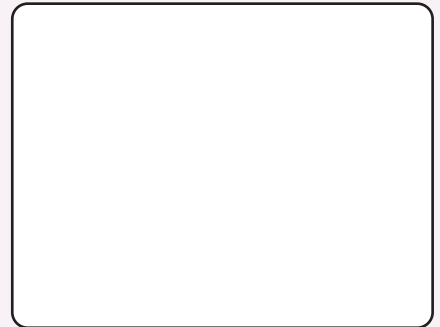
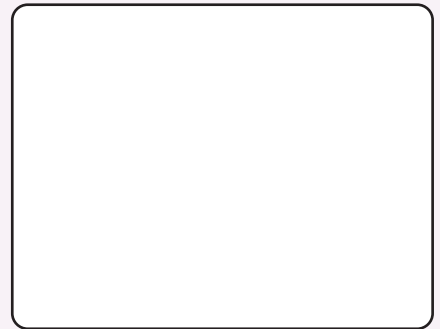
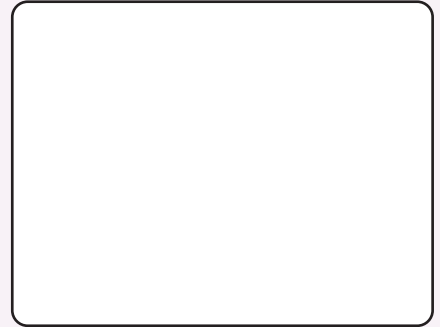
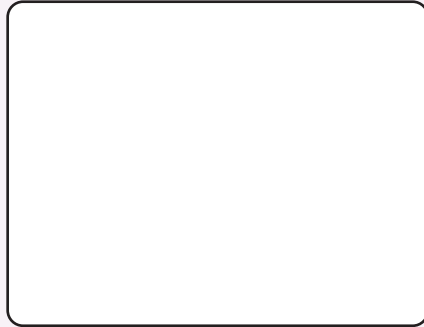

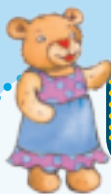

# Cut outs



## Finger puppets:

Choose 1 animal and write the first letter of your name on its t-shirt. Then write the first letters of 4 of your friends' names on the others.



## Picture dominoes:

Cut out the cards on the black dotted lines and then match the numbers to the correct pictures.

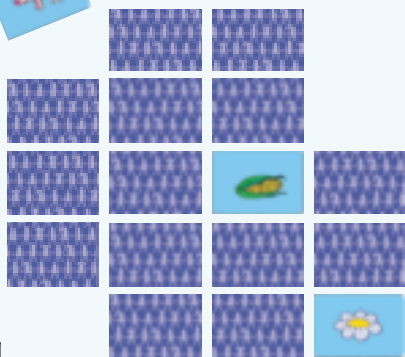

## Memory Game:

Shuffle the cards and pack them out face down on the table. Then, turn 2 cards at a time and see if they match. If they do, put them aside. If they don't put them back. See if you can remember where you put them. The first one to find all the matching pairs is the winner. You can also play snap with these cards.

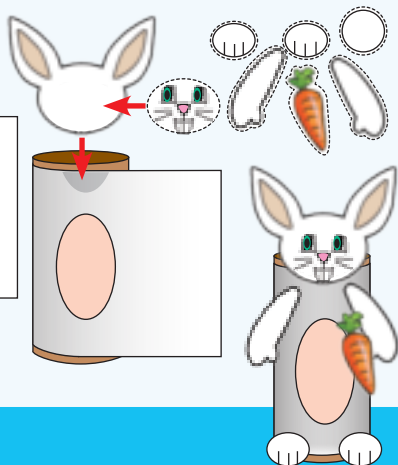
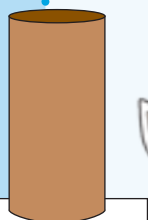

## Toilet roll animals:

Find some empty toilet rolls. Cut out the rectangles and then glue the large rectangular pieces around the toilet rolls to cover the tubes. Now cut out the heads and stick it on the rolls at the top. Use the animal stickers and paste the faces on the heads as you like it. Paste the arms, legs and tail of each animal on the rolls. You can also draw and make your own animals.



Make some zig zag books.  
Cut on the solid lines and  
fold on the dotted lines.



# Numbers

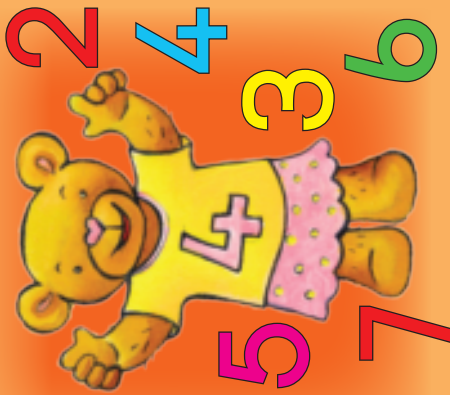

# 1



one

# 2

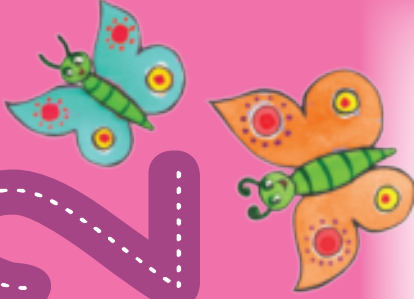

two

# 3



three

# Pets



dog



cat



fish

lizard



four

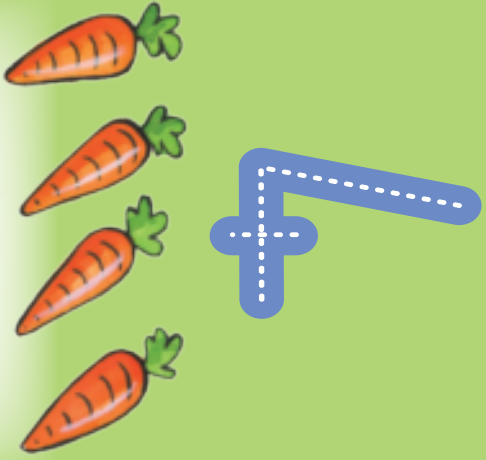

bird

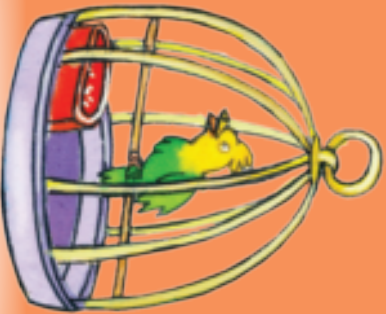

five



hamster



six



rabbit

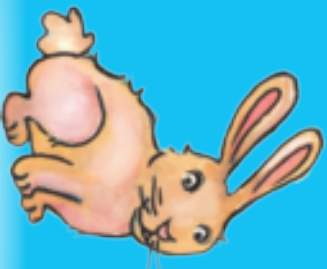

seven

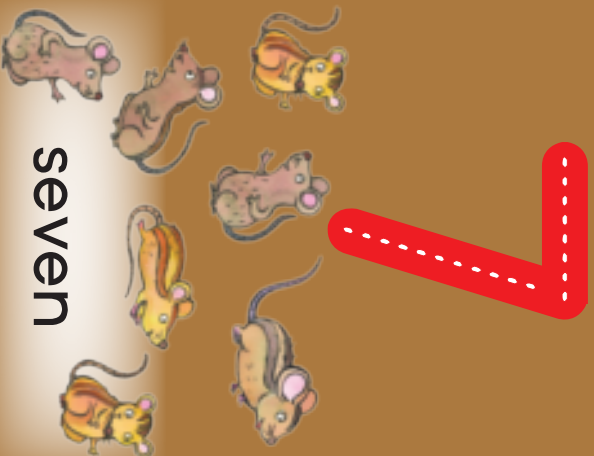



# MY CUT OUTS



Let's do.

Cut the page off on the dotted line at the top and then glue the page to the back cover to make a pocket. Keep your cut outs here so that they don't get lost.

GLUE HERE

GLUE HERE

GLUE HERE

GLUE HERE

FOLD

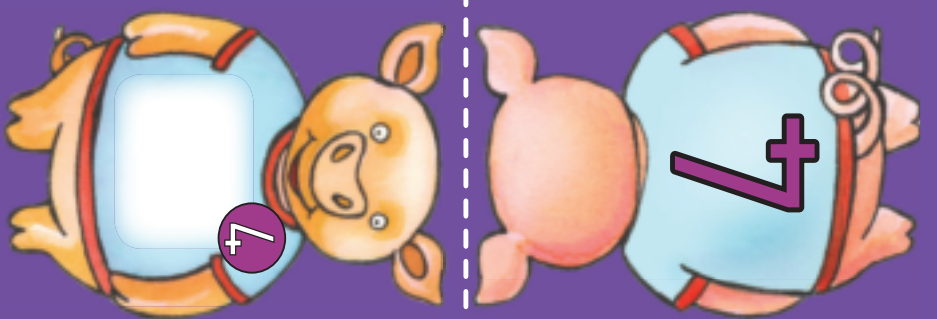

- 0
- 1
- 2
- 3
- 4
- 5
- 6
- 7
- 8
- 9
- 10
- 11
- 12
- 13
- 14
- 15
- 16
- 17
- 18
- 19
- 20
- 21
- 22
- 23
- 24
- 25
- 26
- 27
- 28
- 29

a b c d e f g h i j k l m n o p q r s t u v w x y z



0	a
1	b
2	c
3	d
4	e
5	f
6	g
7	h
8	i
9	j
10	k
11	l
12	m
13	n
14	o
15	p
16	q
17	r
18	s
19	t
20	u
21	v
22	w
23	x
24	y
25	z

GLUE HERE

GLUE HERE

GLUE HERE

GLUE HERE

GLUE HERE

GLUE HERE

GLUE HERE

GLUE HERE

GLUE HERE

GLUE HERE



1



2

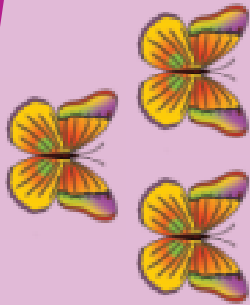

3

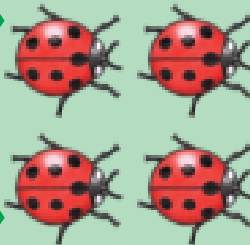

4

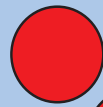

5

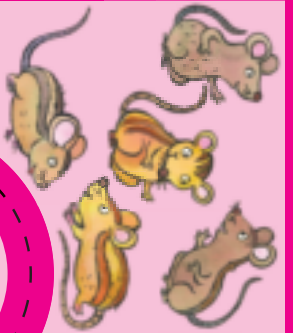





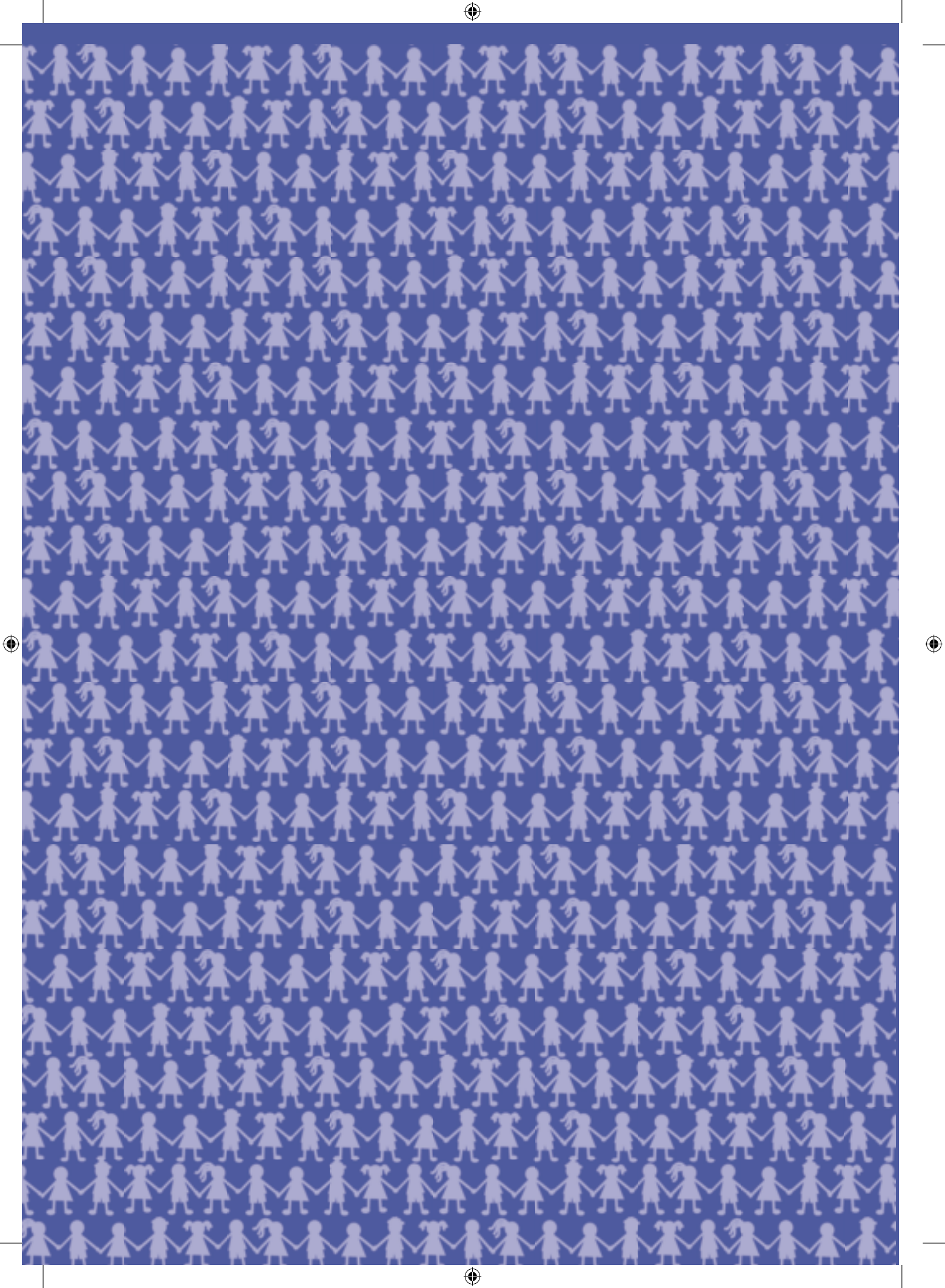

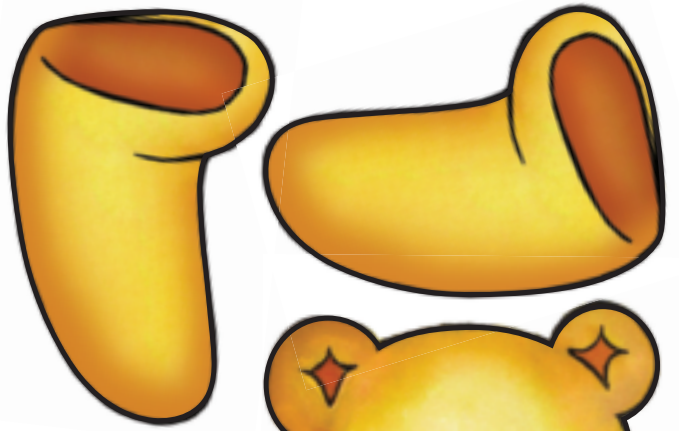
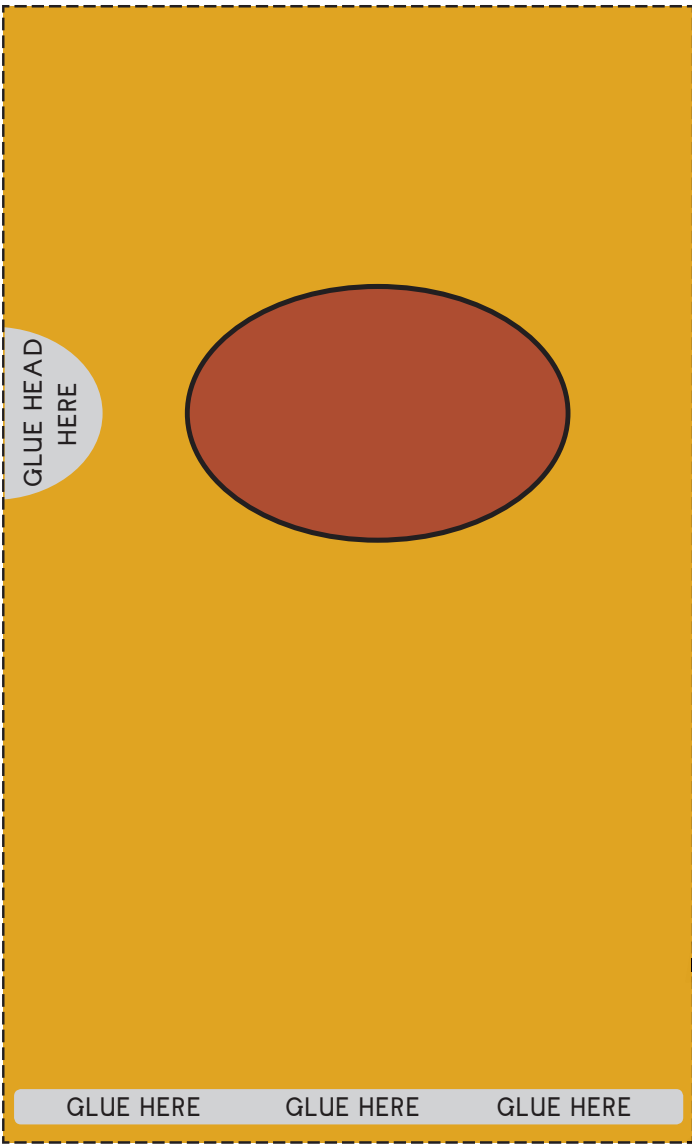

**TEDDY BEAR**

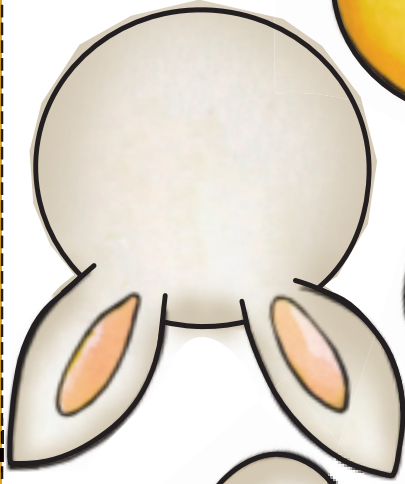

**RABBIT**

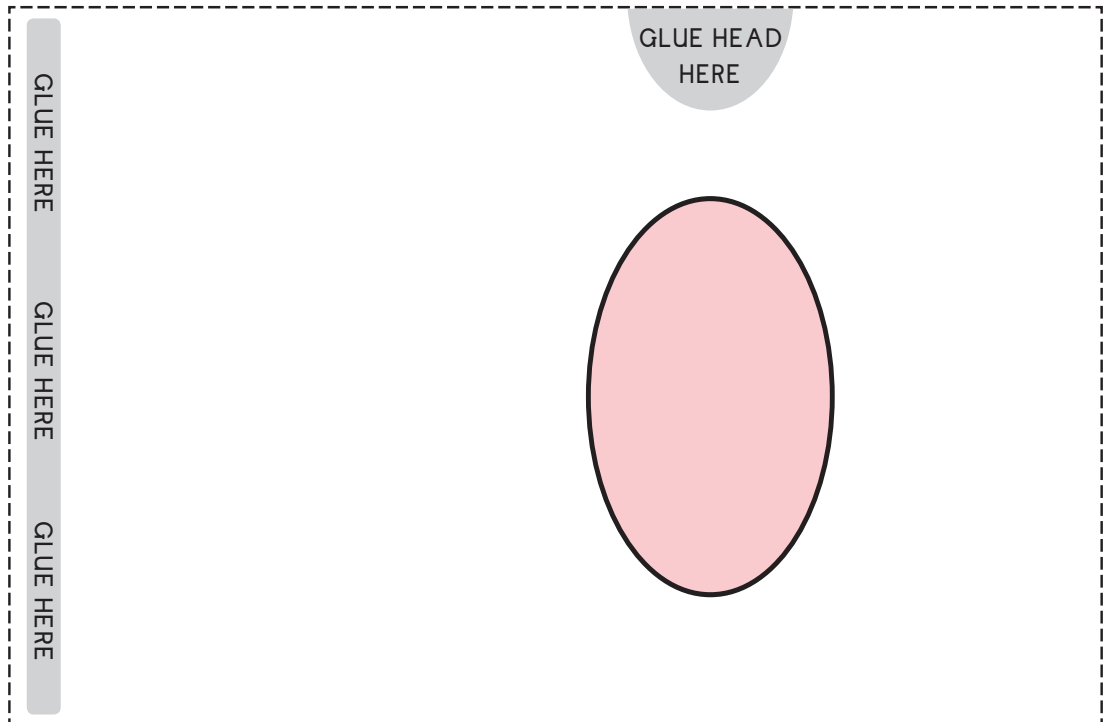

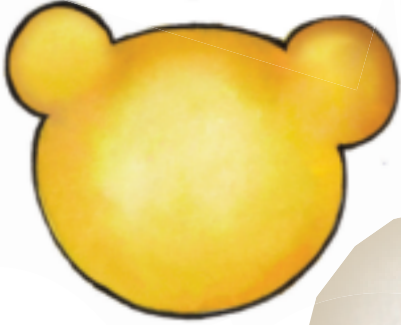
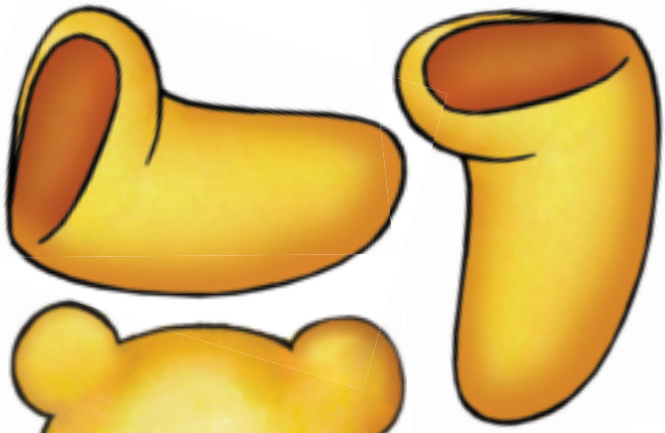

# STICKERS

GRADE R BOOK1

8



6



12



20



30

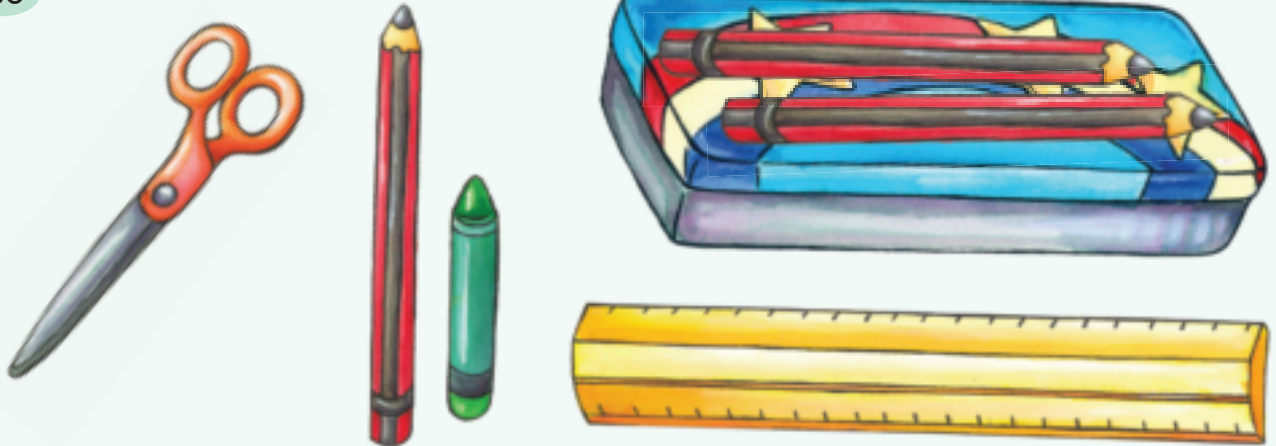

31



43



47



49-50



TEDDY BEAR

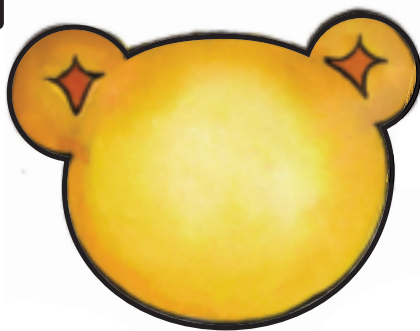

ARMS

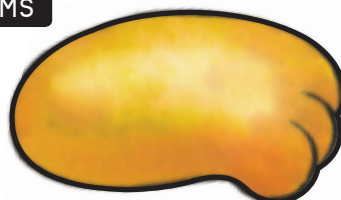
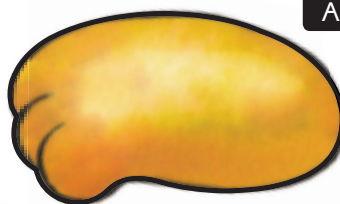

NOSES & MOUTHS

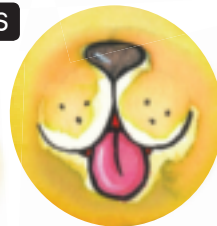

TAILS

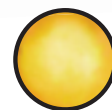
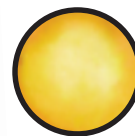

EYES

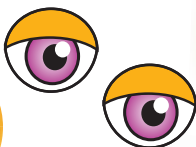

FACES



ARMS



TAILS



EYES



FACES

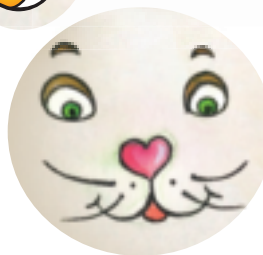

RABBIT

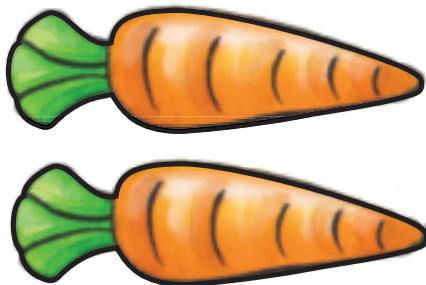

12

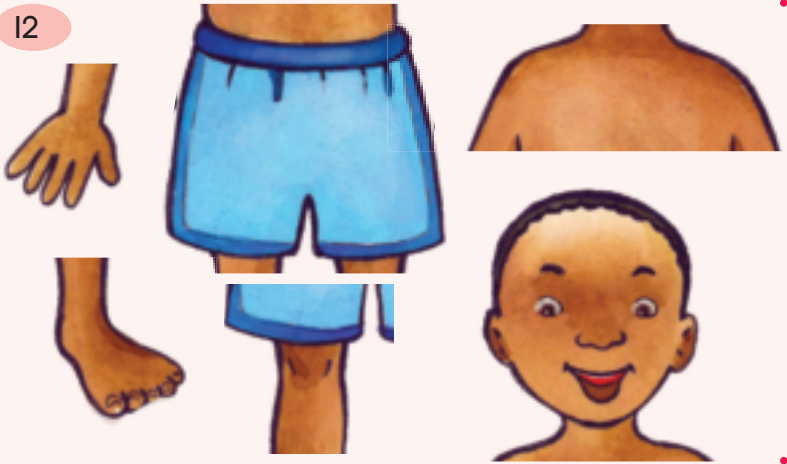

33



30



41

