



E boeleditšwe
ebile e sepelelana
le CAPS

Mphato wa **R**



Leina:

Empty rectangular box for writing the name.

SEPEDI
GRADE R – BOOK 1
TERM 1
ISBN 978-1-4315-0694-1
THIS BOOK MAY NOT BE SOLD.
14th Edition



basic education
Department:
Basic Education
REPUBLIC OF SOUTH AFRICA



SEPEDI
Puku
I
kotara ya l



Mdi Angie Motshekga.
Tona ya
Thuto ya Motheo



Ngk. Reginah Mhaule.
Motlatša-Tona ya
Thuto ya Motheo

Dipukutšhomo tša Rainbow tša ngwaga wa mathomo wa Mphato wa R ke maano a Kgoro ya Thuto ya Motheo a go kaonafatša mošomo wa sekolo wa bana ba Afrika-Borwa. Dinyakišišo di bontšha gore ngwaga wo mongwe le wo mongwe wo bana ba ikhwetšago ba dira ditiro tše di ba fago mafolofolo pele ga Mphato wa 1. ba dira bokaone dithutong tša bona mengwaga ye e latelago - dithutong tša bona tša praemari le tša sekontari. Ke ka lebaka leo go lebelelwago kudu dithuto tša Mphato wa R.

Lenaneothuto la Kgato ya Mathomo le nyaka gore barutwana ba Mphato wa R ba fiwe sebaka sa go tšwetša pele bokgoni bja pele ba ka bala le pele ba ka ngwala gammogo le bokgoni bja tša mmetse. ba tla swanela go hwetša motheo wo o tiilego wa tša thuto gore ba kgone go kwešiša bokaone ge ba ithuta tša Mphato wa 1 le go ya pele.

Ka lebaka leo dipukutšhomo tša Mphato wa R di lebišitšwe go ruta bana le go tšweletša pele mabokgoni a le dikgopolo tše bohlokwa tša mathomo tše ba di nyakago go aga motheo wa go tia wa go ithuta. Di fa bana sebaka sa go tšwela pele le go ithuta mabokgoni ao a tla ba lokišetšago thuto ya semmušo.

Pele bana ba ithuta go bala ba swanela go ithuta go swara pene le puku le go phetlolla matlakala a yona le go kwešiša gore dipuku di šoma bjang. Ba swanela go kwešiša tswalano magare ga mantšu le diswantšho tše di lego ka pukung le go lemoga gore mantšu mo letlakaleng a agiwa ke medumo gomme a na le tlhalošo. Ka wona mokgwa woo pele bana ba ithuta go ngwala ba swanela ke go tšwetša pele nyalano ya tšhišinyego ya dikwi go ithuta go agega ga dibopego gomme ba tšwela pele ka go hlama maletere. A ke ona mabokgoni a nnete ao dipukutšhomo tše di lebišitšego go a tšwetša pele.

Re a tseba gore bana ka moka ga ba ithute ka lebelo la go swana. Dipukutšhomo tša Mphato wa R di kgontšha barutiši go lebelela lebelo leo ngwana yo mongwe le yo mongwe a ithutago ka lona ge go kgonagala; go boela morago. gape ge go kgonagala ba ya pele ka mo pukung go ya ka bokgoni bja ngwana yo mongwe le yo mongwe. Gape mešongwana ye e tla thuša barutiši go lemoga mathata ao bana ba ka bago le ona ge ba ithuta gore a tle a hlokomelwe pele ngwana a thoma ka dithuto tša semmušo.

Dipukutšhomo tše di kopantšha go ruta tsebotlhaka le go ruta mmetse le mabokgoni a bophelo e le karolo ya merero ye 20 ka go šomiša go bapala le go šomiša mekgwa ya go dira gore barutwana ba bannyane ba be le kgahlego le šedi ya go ithuta. Re hutša gore barutwana ba gago ba tla ipshina ka go šomiša mešongwana ye e lego ka go dipukutšhomo tše. ge ba dutše ba gola ba bile ba ithuta. le gore wena bjalo ka morutiši wa bona o tla thaba le bona.

Tirišanommogo



Go aga lelepa...



basic education
Department:
Basic Education
REPUBLIC OF SOUTH AFRICA



SCAN HERE
or visit OMO.CO.ZA
for fun activities in
the OMO Messy
Play Zone.



Mphato
wa

R

DI KOPANTŠWE

- Leleme la gae
- Mmetse
- Mabokgoni a bophelo



1	Ka ga nna	2
2	Mmele wa ka	12
3	Ka phapošingborutelo.....	24
4	Go phela gabotse	32
5	Bagwera	42

SEPEDI

Puku ya

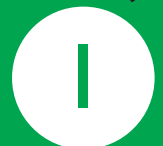

Kotara ya I

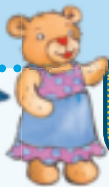

Ka ga Nna



Kotara ya 1 – Beke 1-5



Gatšetša o be o malafatše.

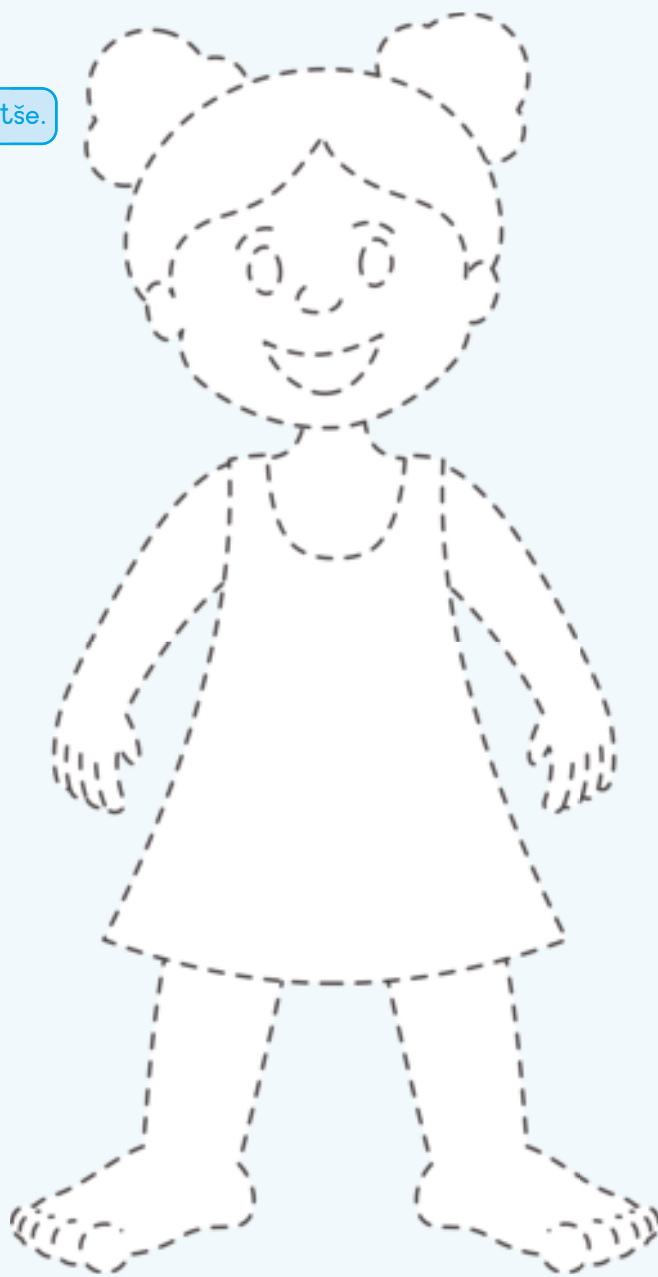

Ke nna

mosetsana



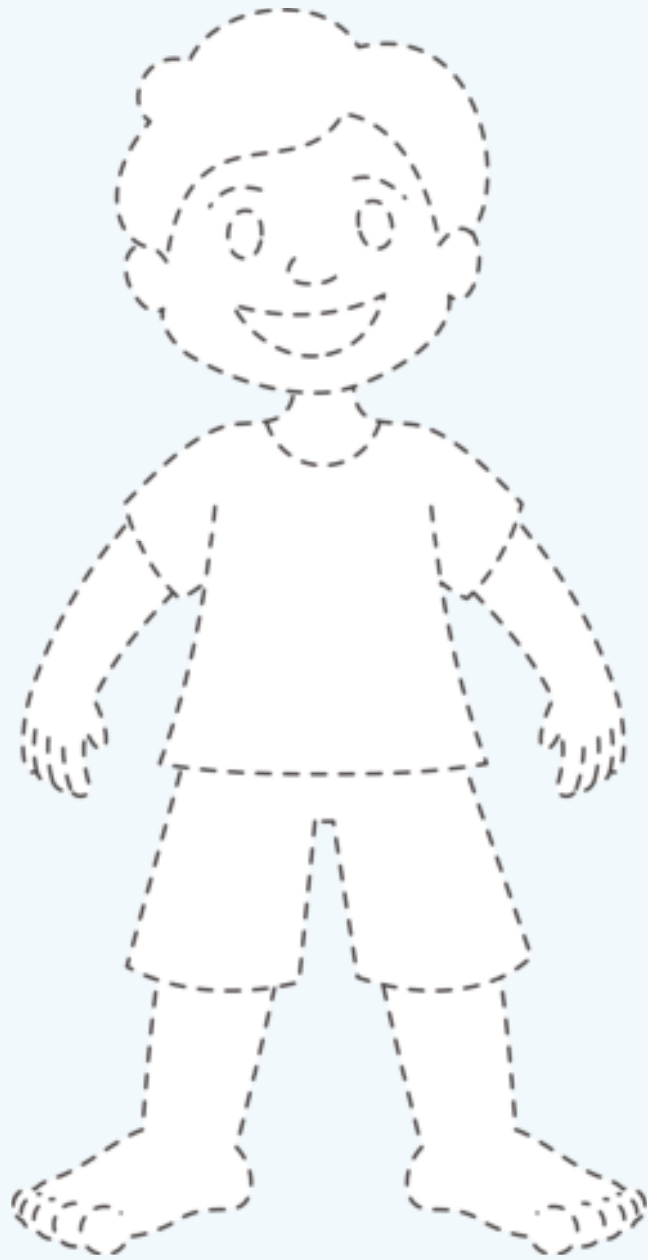

Ke nna

mošemane



Thala seswantšho sa gago.

Kotara ya 1 – Beke 1-5



1.2



Ke na le mengwaga e mekae?

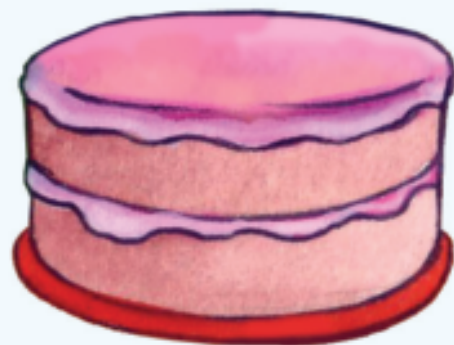
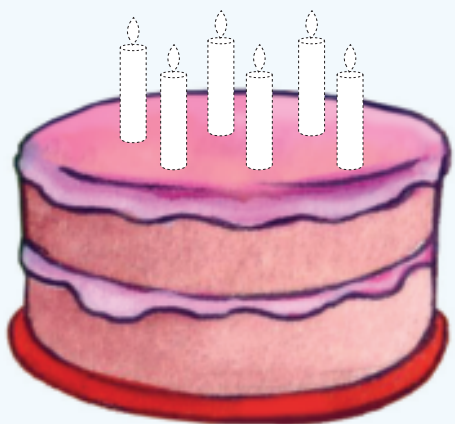
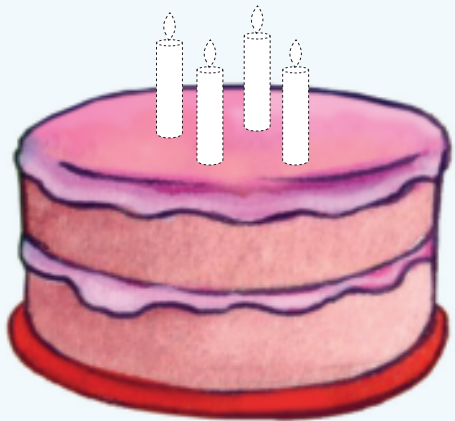

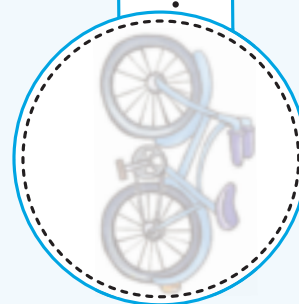
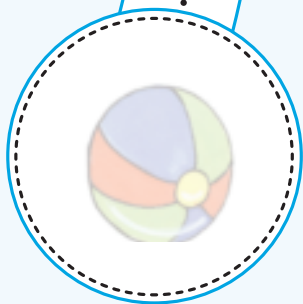

Šomiša monwana morago o šomiše kherayone go gatišetša.



Mmala wa mahlo a ka

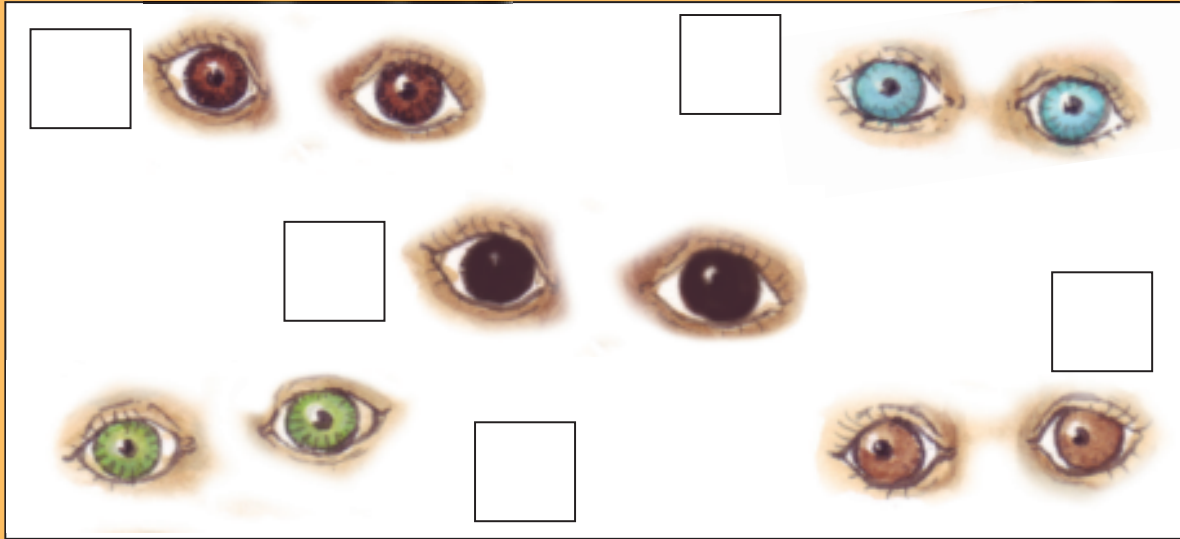

Mmala wa moriri wa ka

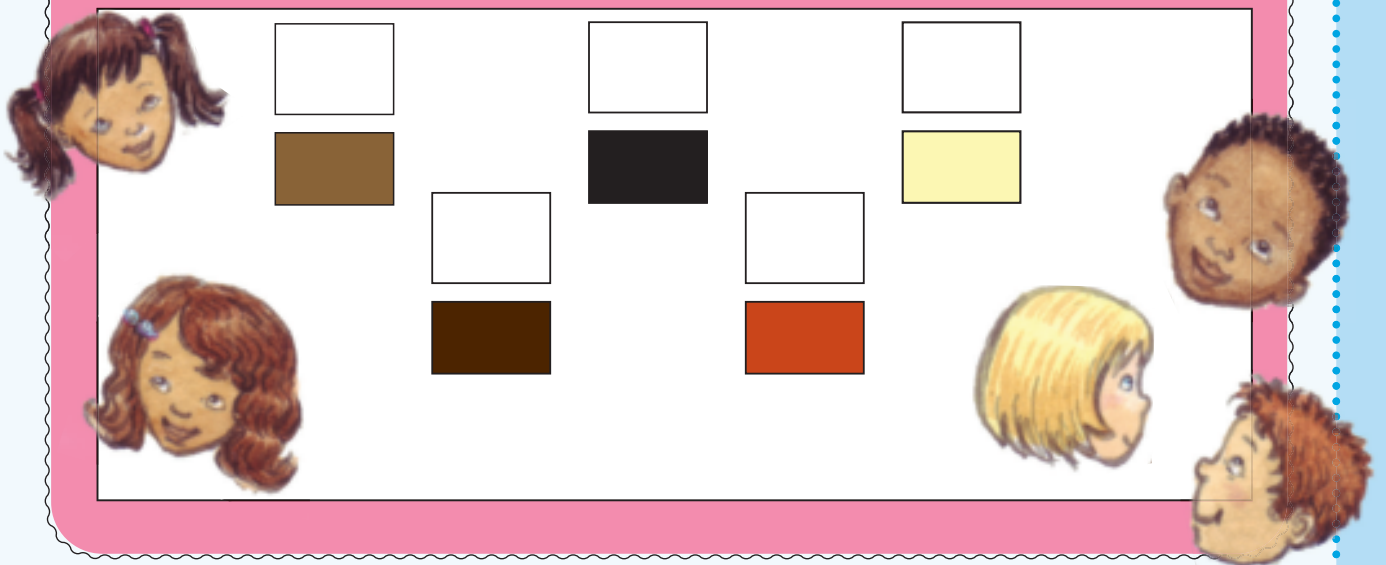

15



Thala sefahlego sa gago.

Kotara ya 1 – Beke 1–5





Bolela ka seo o se ratago o be o swaye.

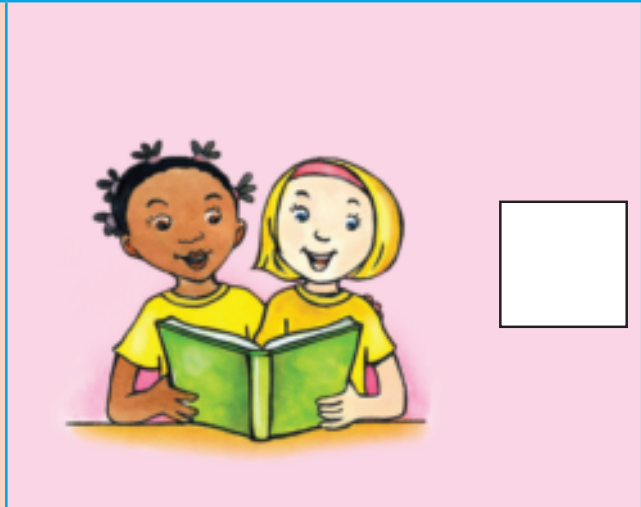
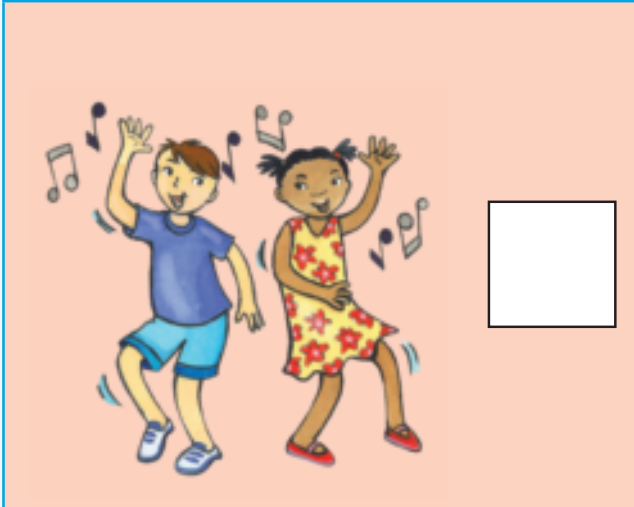







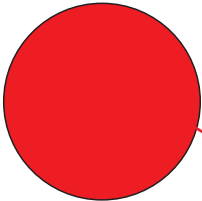



Lebanya ka go thala mothladi.

Kotara ya 1 – Beke ya 1-5



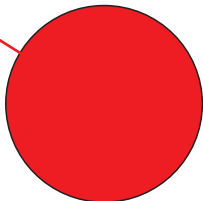









Raretša selo ka se tee ka lepokisaneng o be o gatišetše.

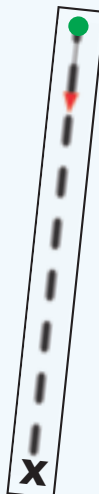
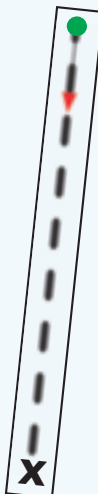
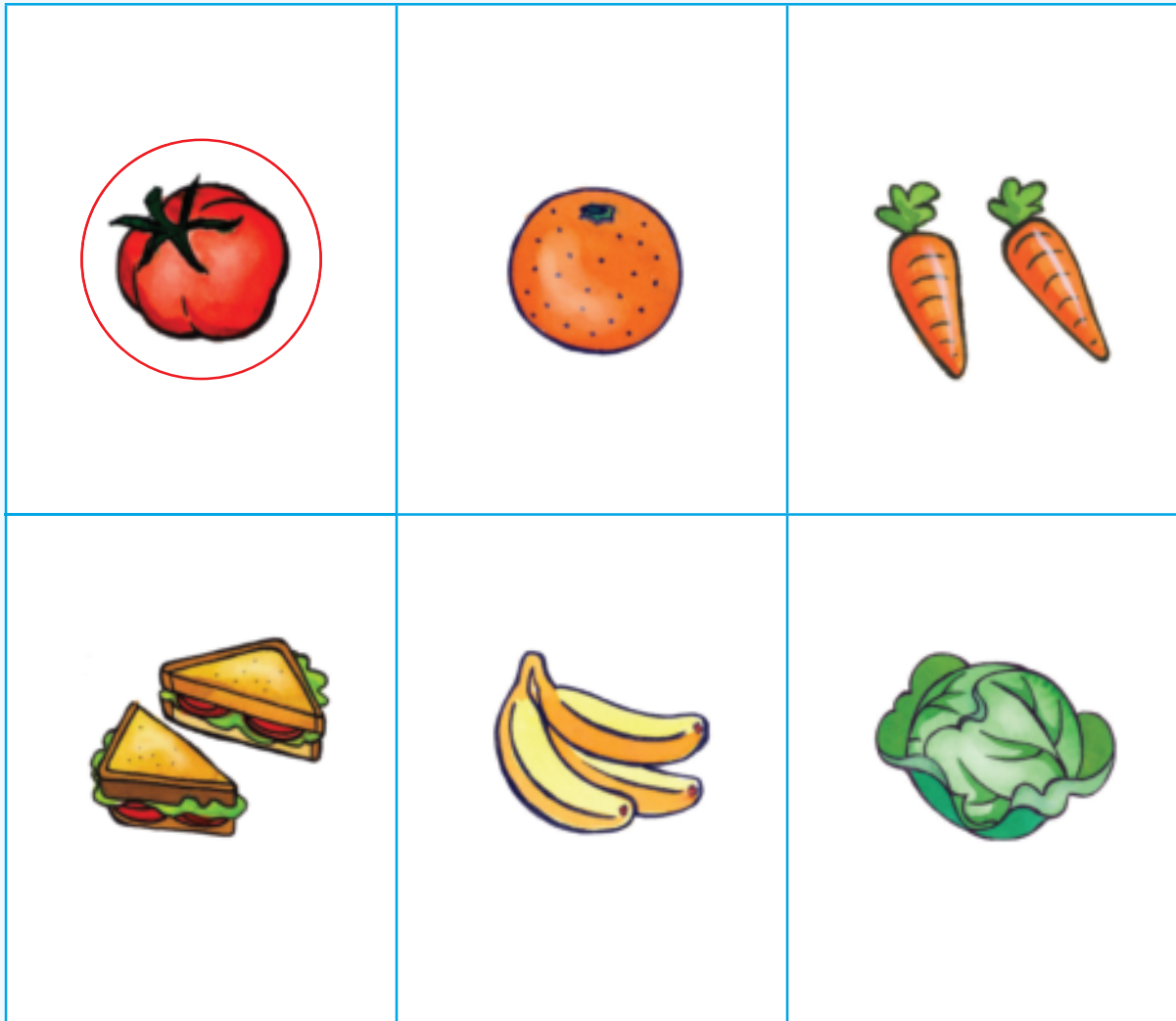

2

Mmela wa ka



Ahlaahla seswantšho gomme o mamaretše tšeo di sego gona.

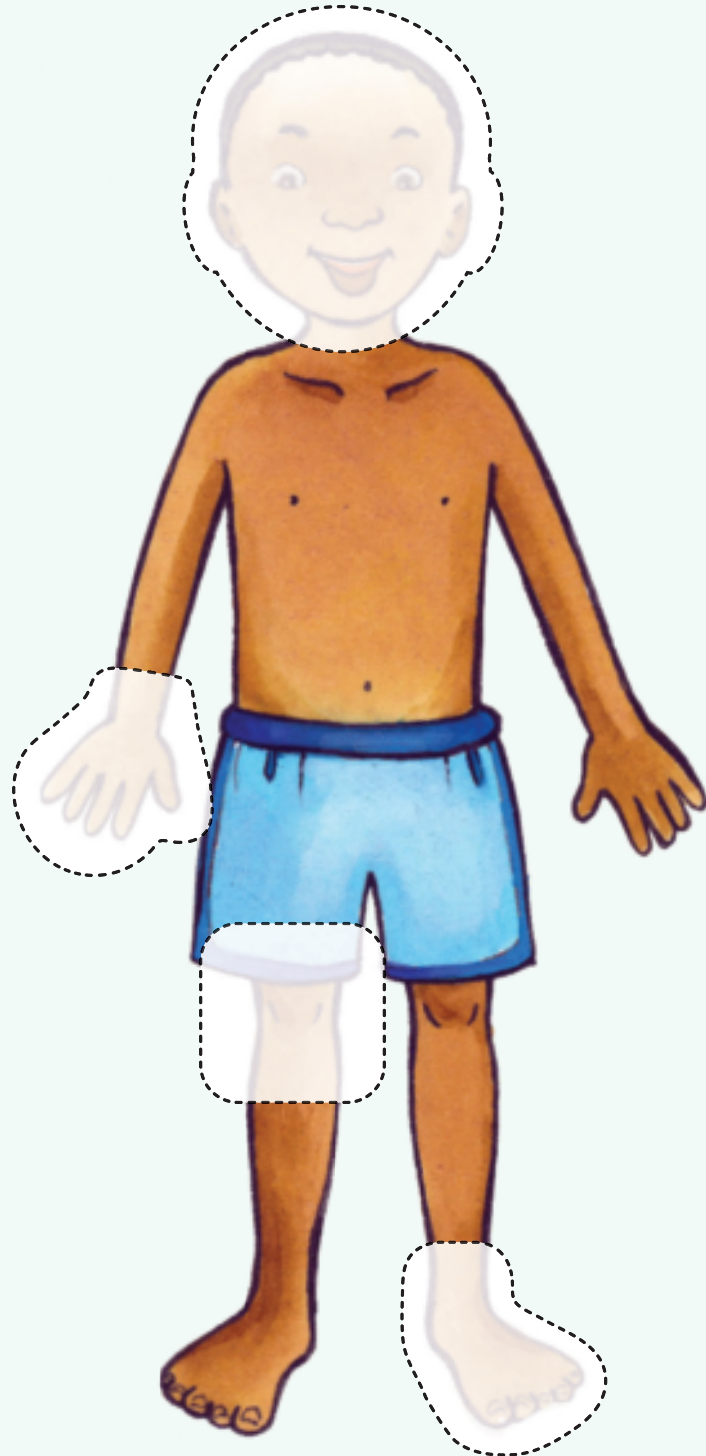

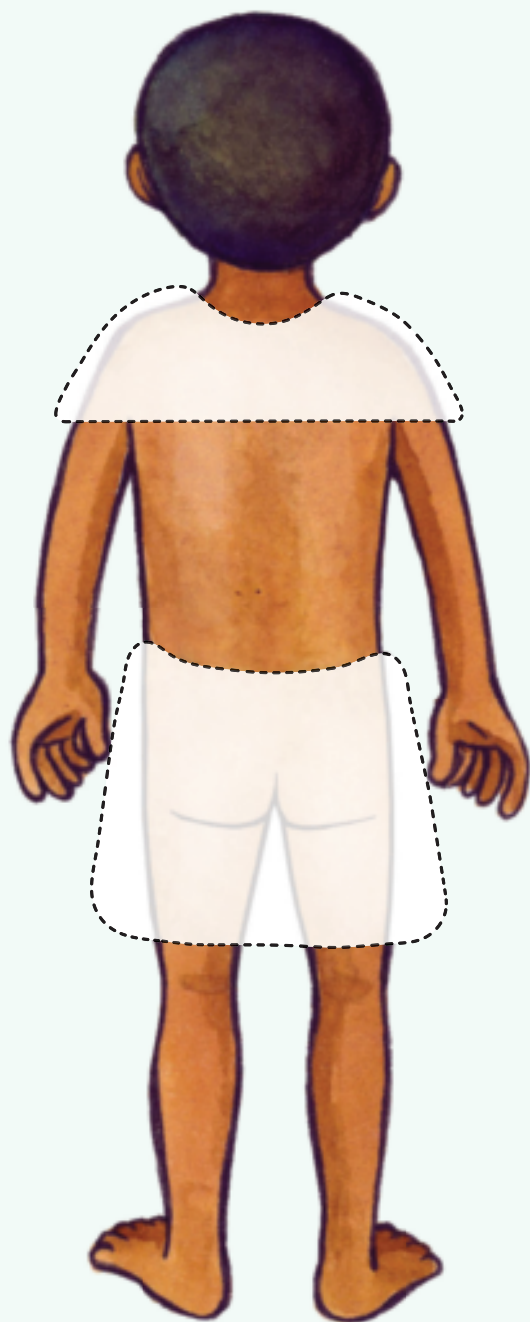

21



Gatīša o be o malaf atše dibopego.

Kotara ya 1 – Beke 1-5

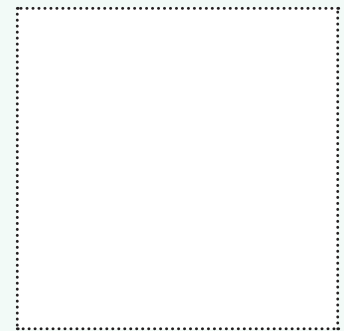
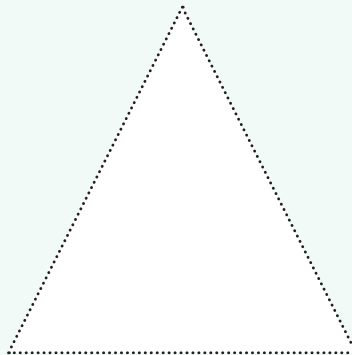
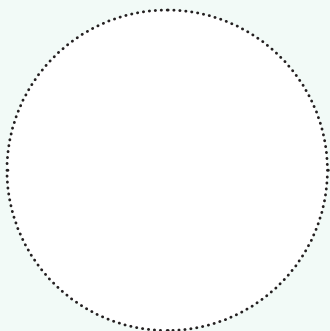
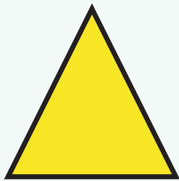
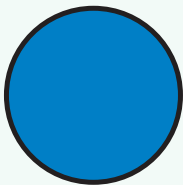
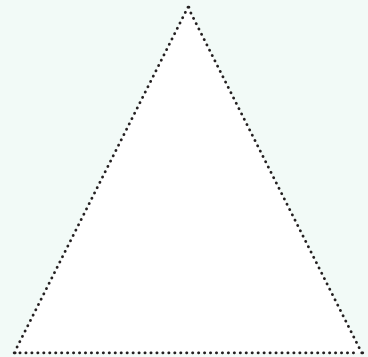
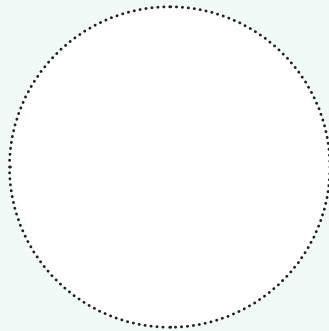
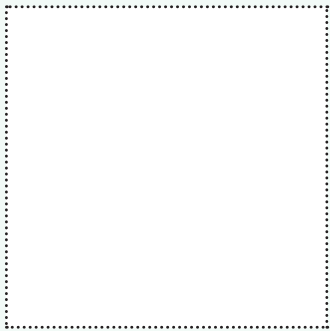
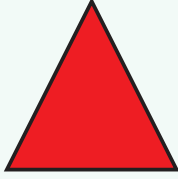
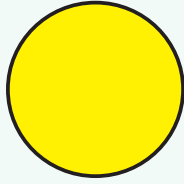
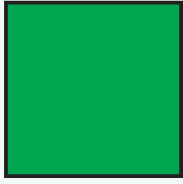

2.2



Menaganya letlakala go laetša mothaladi wa simethiri.

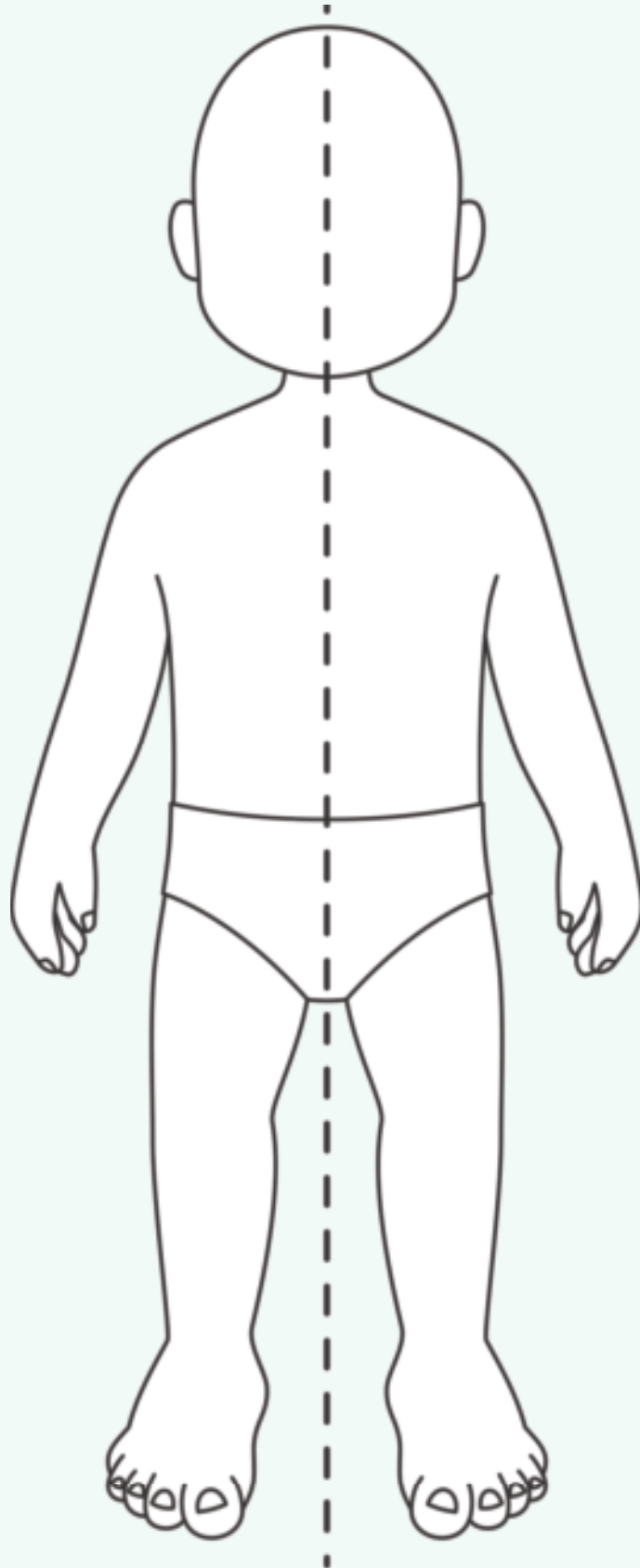

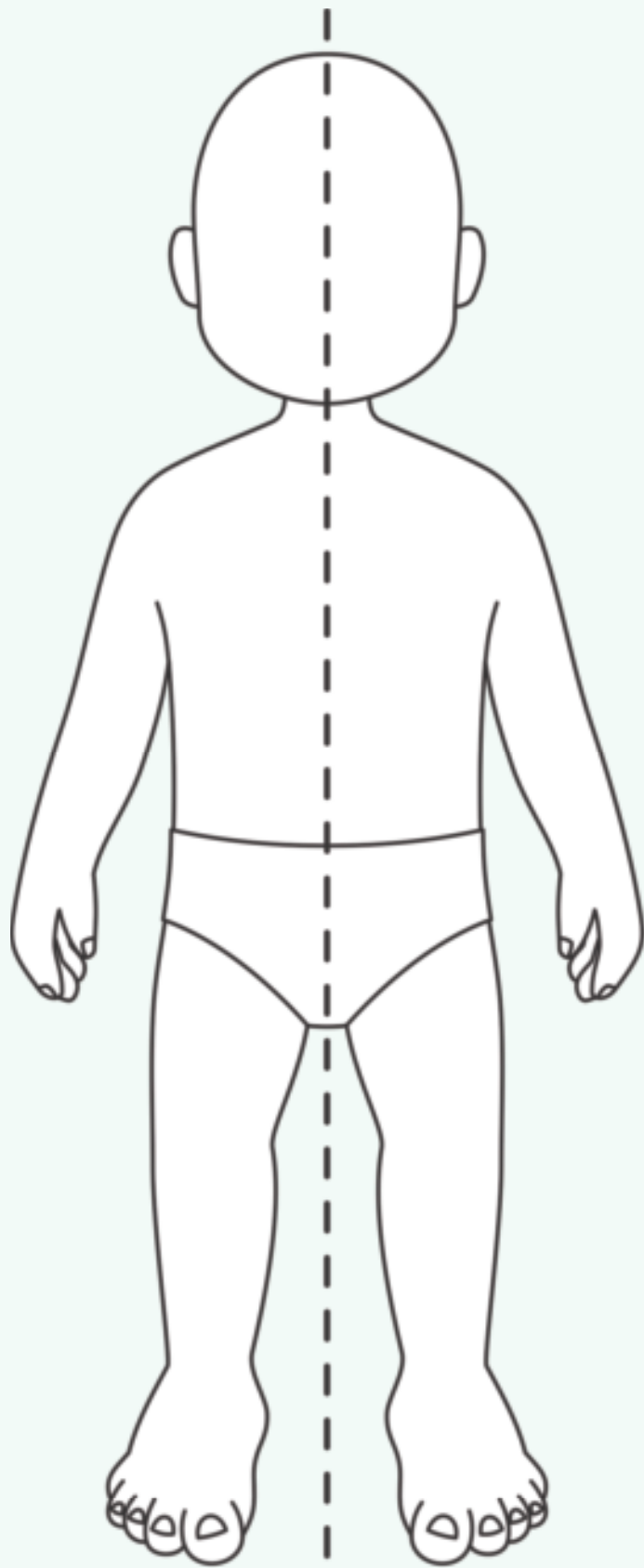

2.3



Ripa o mamaretše ka maleba.

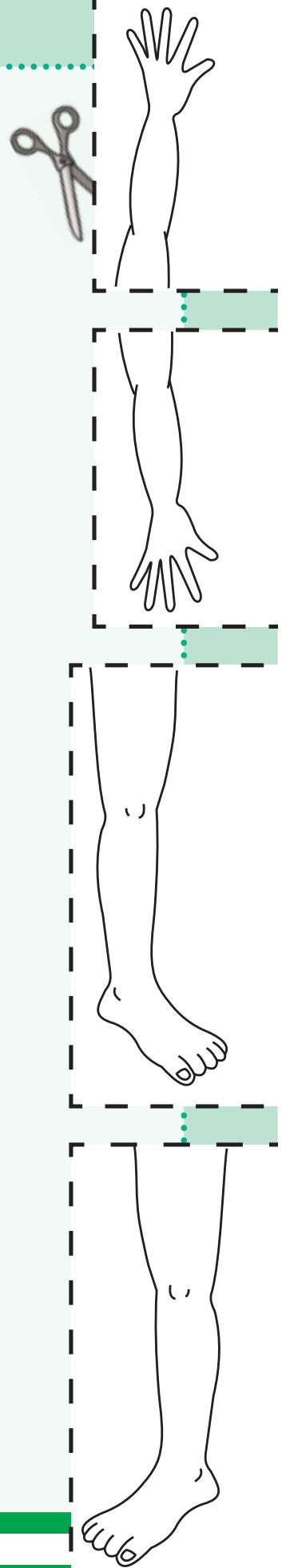
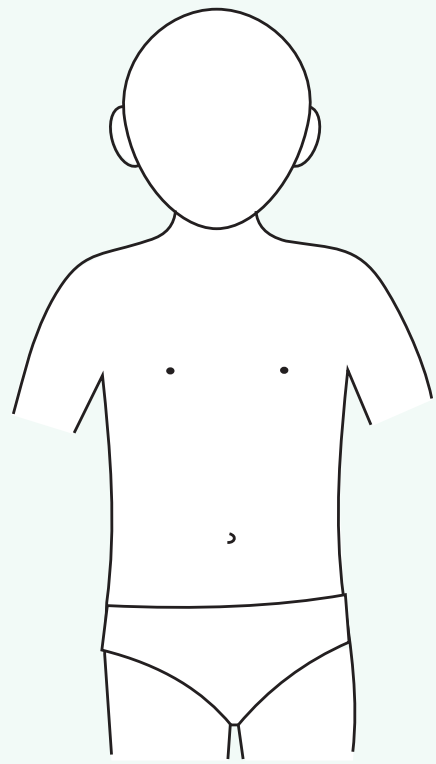

2.4



Gatšša seatla sa go ja/sa ngele.



Dira kgatššomenwana ka mo fase.





Ahlaahla tatelano ya ditiragalo tša mesong.

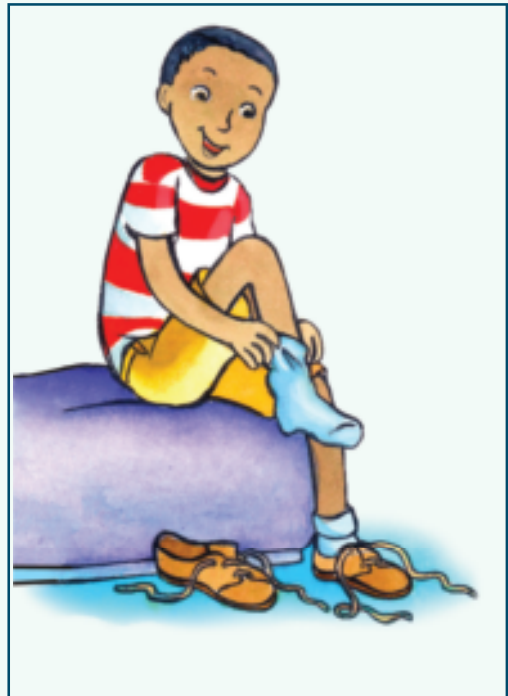
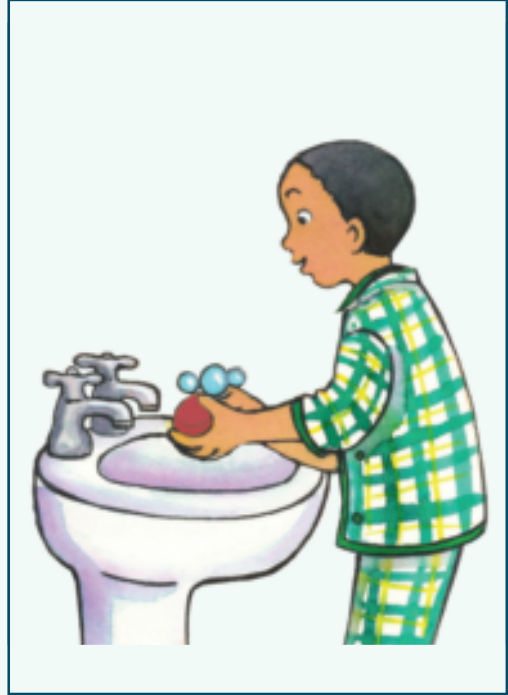





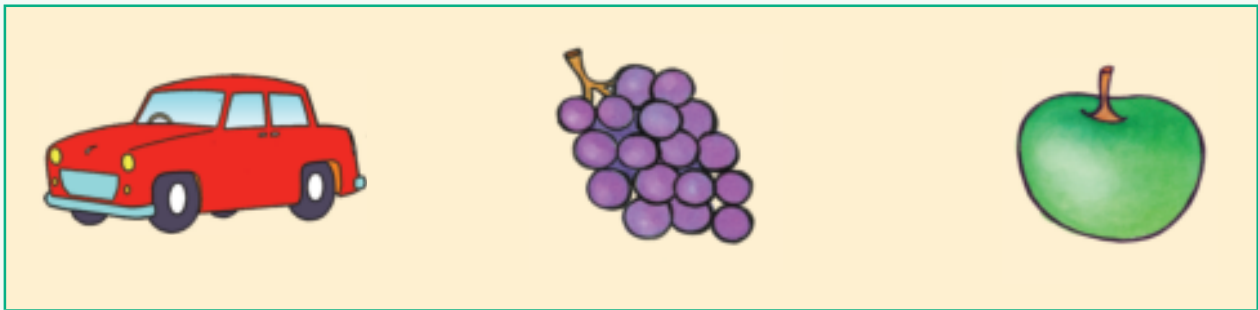
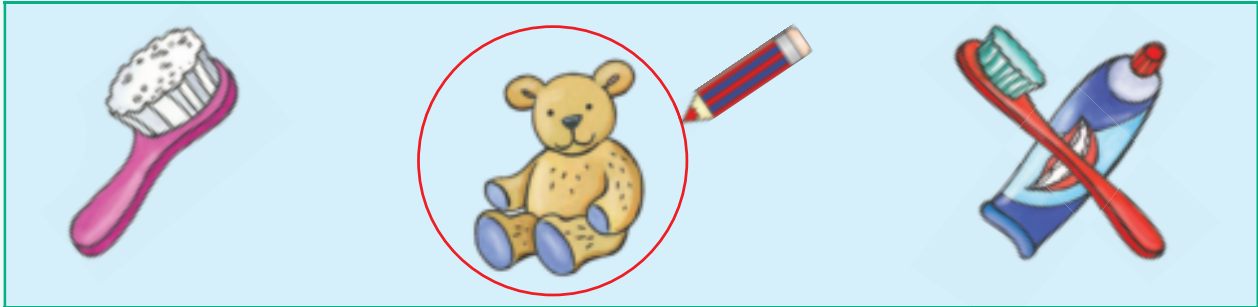

Raretša yeo e sa sepelelanego le tše dingwe.









Raretša sefahlego seo se sepelelanago le sa mathomo.

			
---	---	--	---

			
---	--	---	--

			
---	---	--	---



Gatšetša dibopego go boeletša paterone.

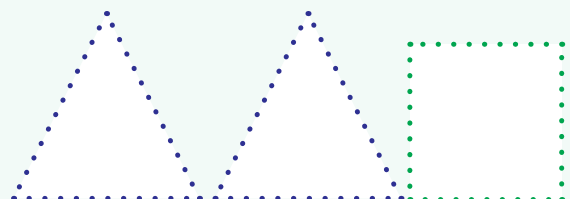
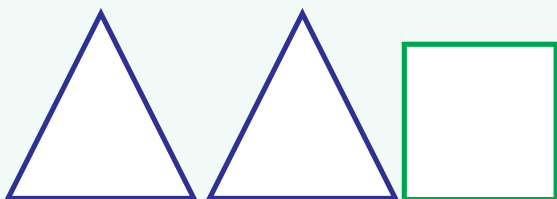
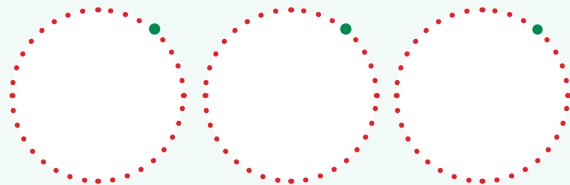
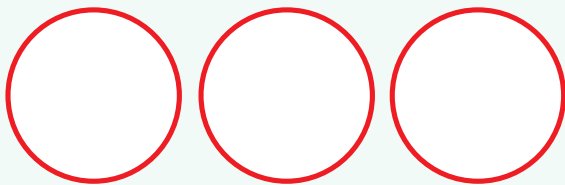
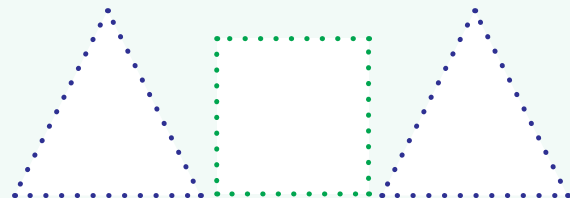
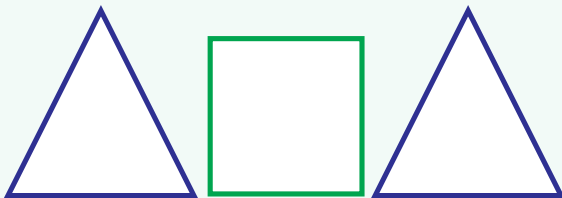
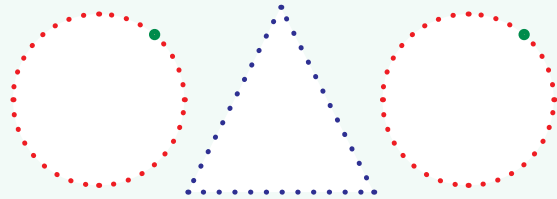
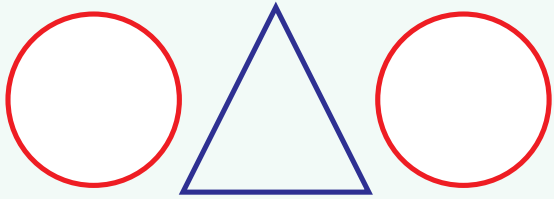

Ka phapošingborutelo



Ahlahla seswantšho.



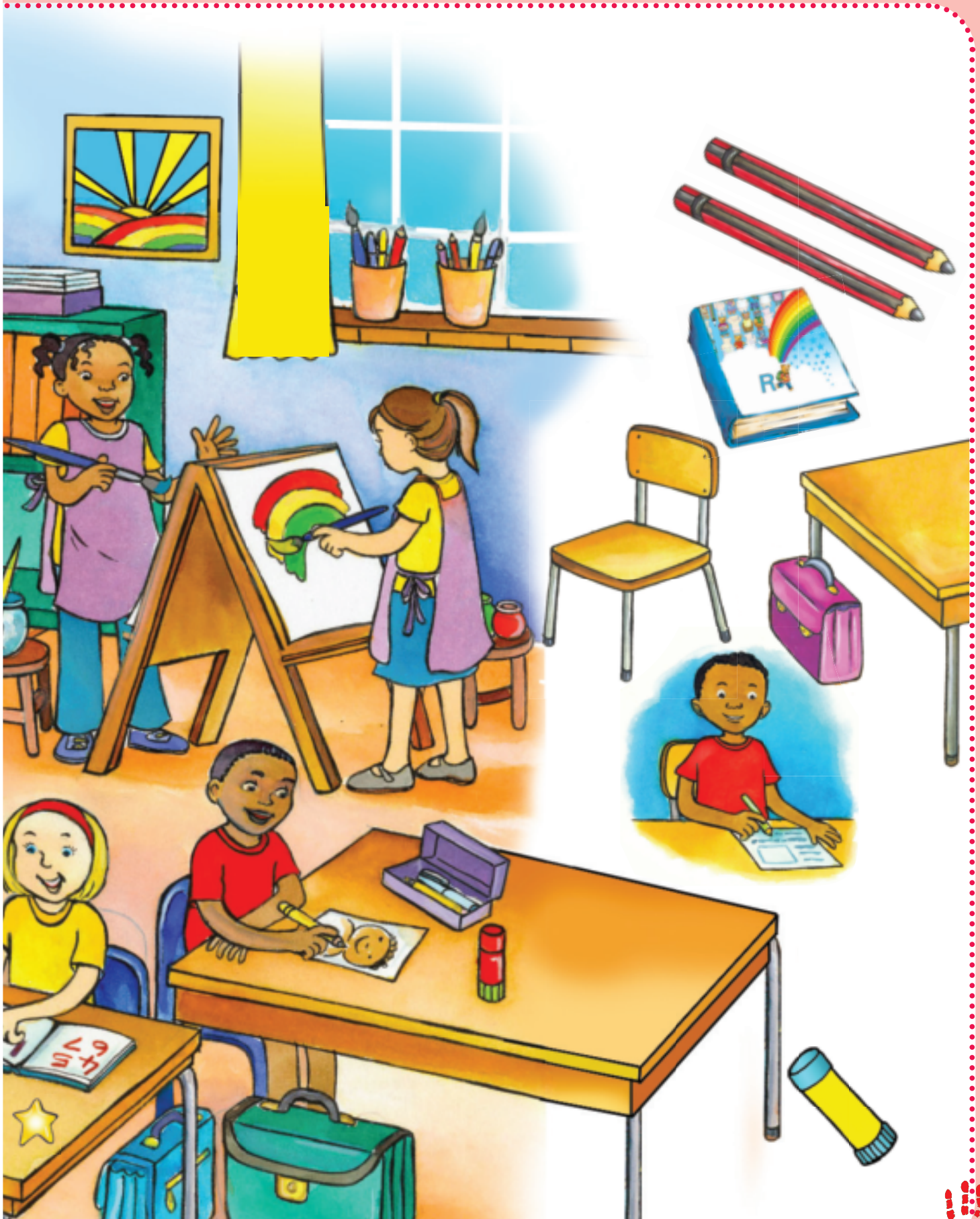

3.1



Gatišetša dithapo, swaya ✓ palunu ya thapo e telele, o raretše palunu ya thapo e kopana.

Kotara ya 1 – Beke 1–5

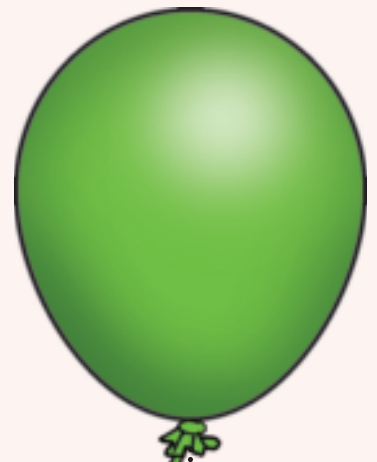
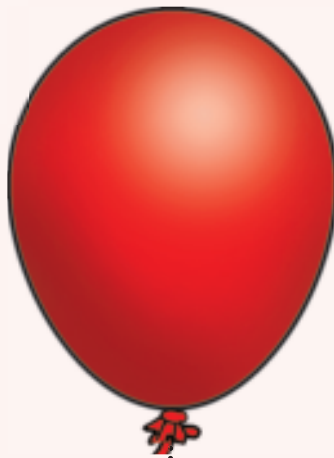
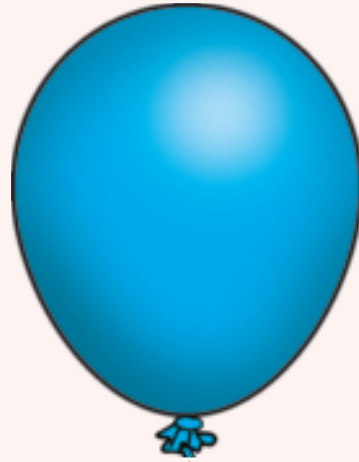
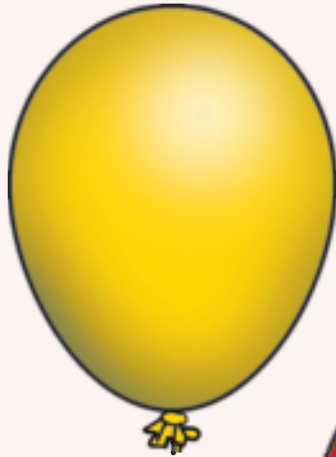

3.2



Balela, o raretše dilo tše 2 ka lepokising le go gatišetša nomoro ya 2 ka fase.

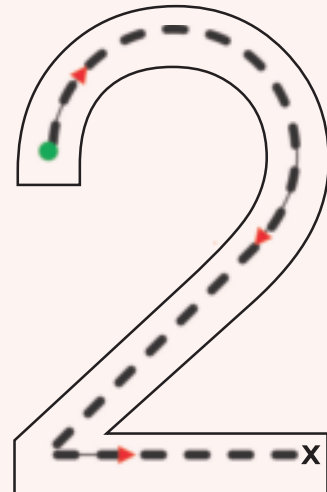
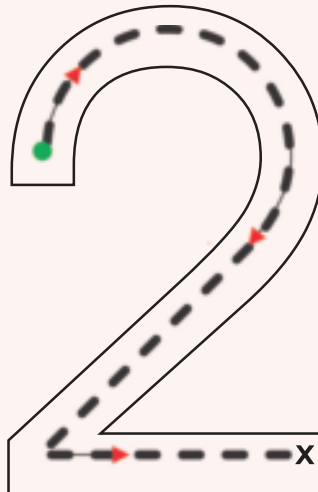
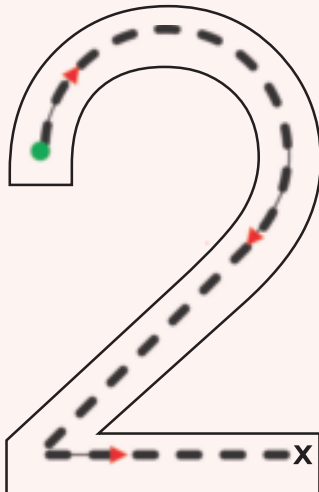



Malafatša dilo tše 2 mothalong o mongwe le o mongwe.

Kotara ya 1 – Beke 1-5

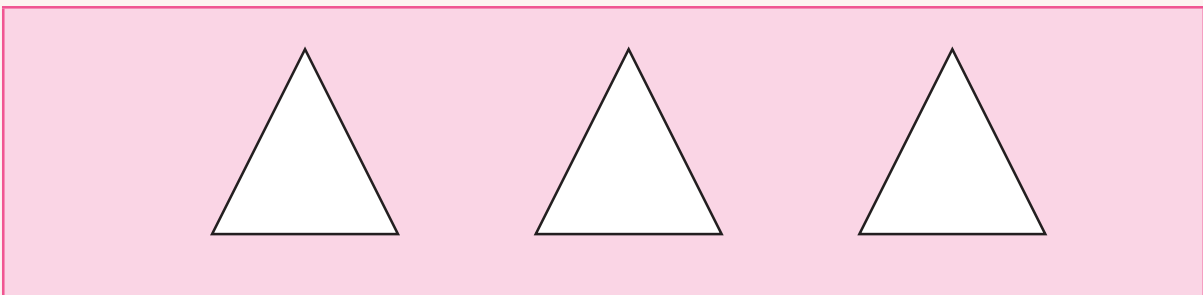
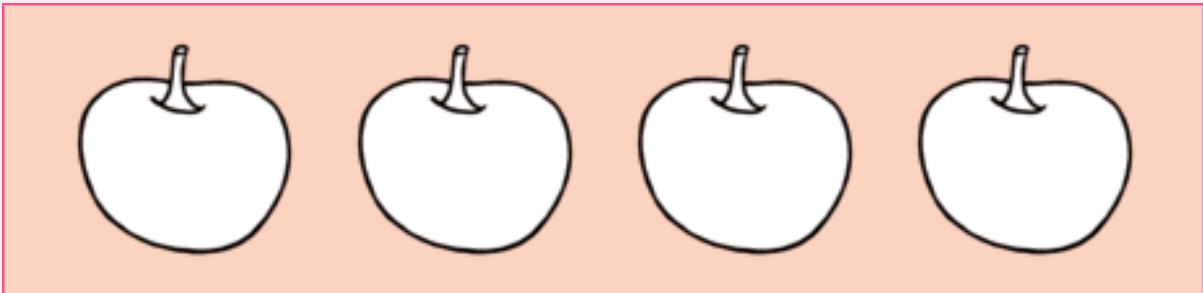

3.4



Bolela ka ditiragalo tša letšatši le letšatši.





Mamaretša dimamaretšwa ka gare ga mokotla wa sekolo.





Gatišetša tsejana.

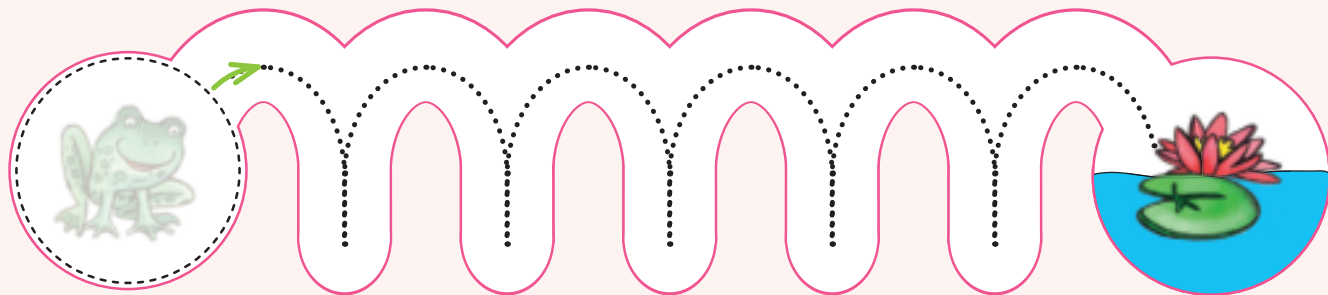
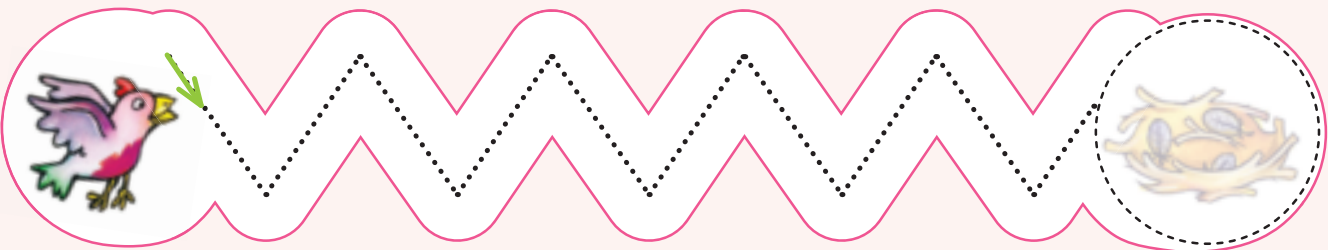
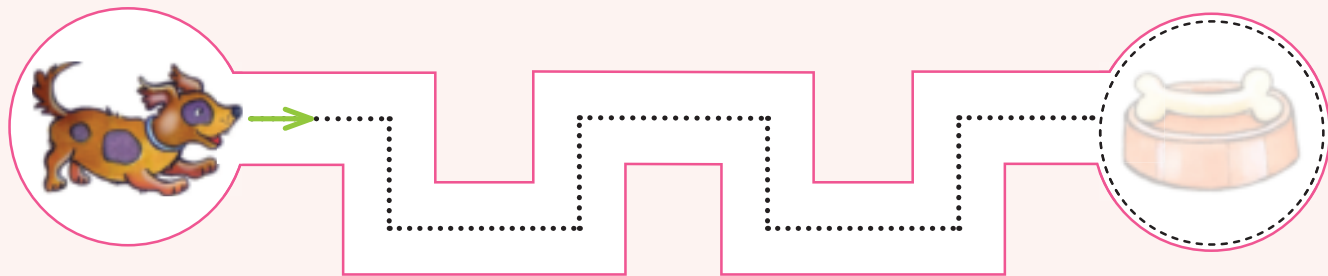
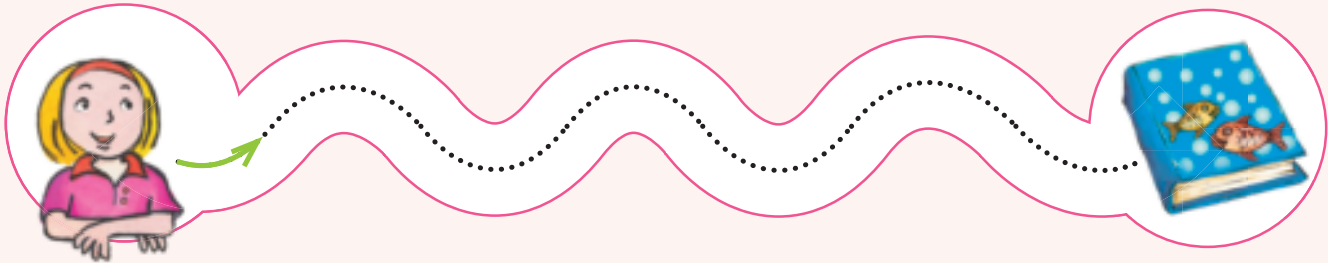

4

Go phela gabotse

Kotara ya 1 – Beke 6–10



Ahlaahla seswantšho.







Gatišetša go latela marothorotho.

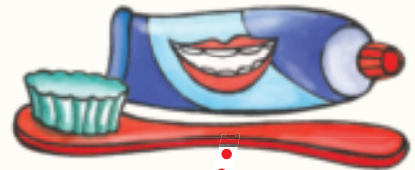
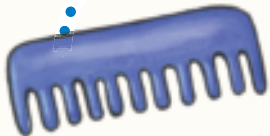

4.2



Gatišetša go latela marothorotho o be o malafatše.

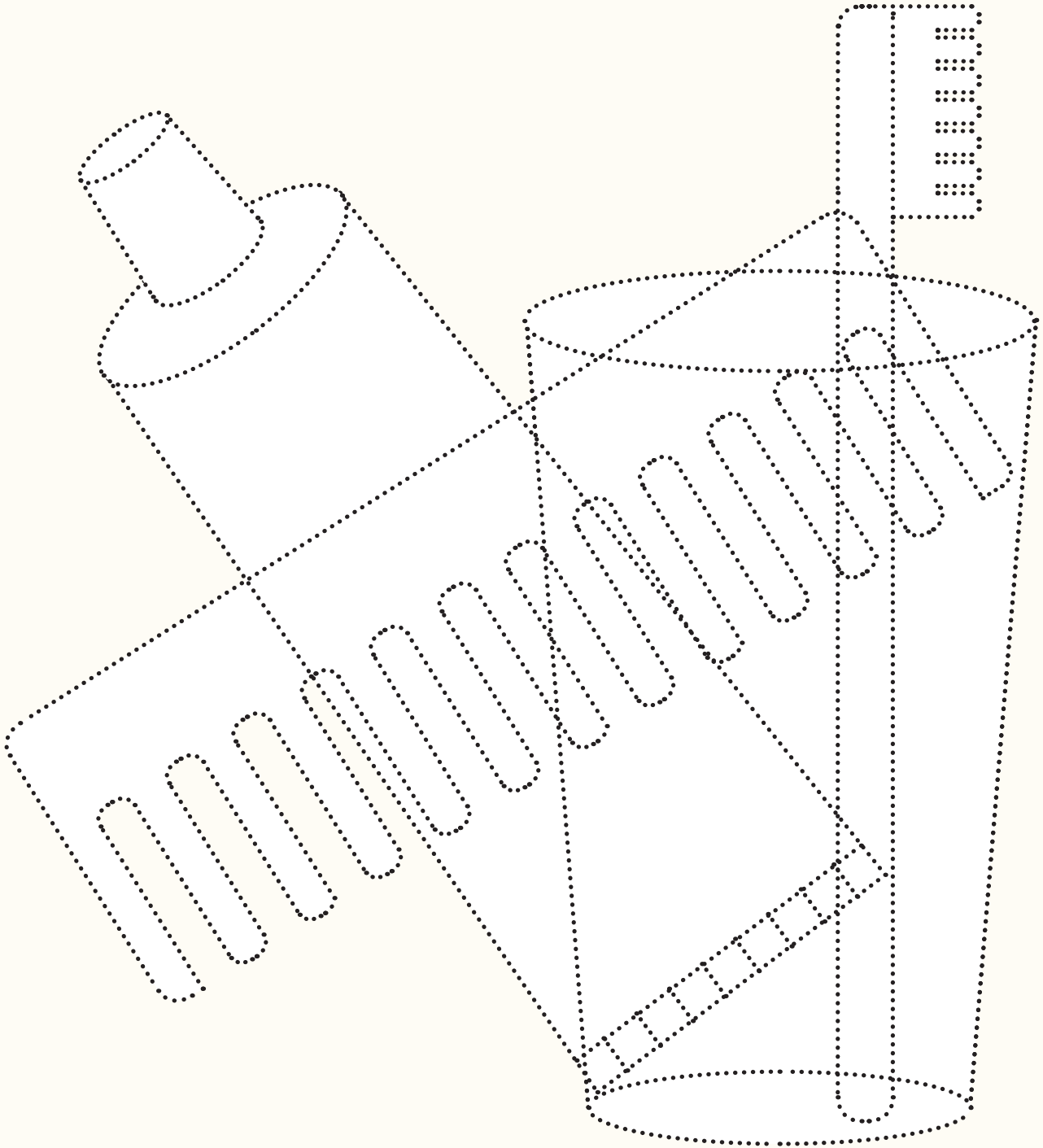



Balela, o raretše dilo tše 3 ka lepokising le go gatišetša nomoro ya 3 ka fase.

		
		
		





Latela methalo ya marothorotho go ripa seswantšho go aga phasele.

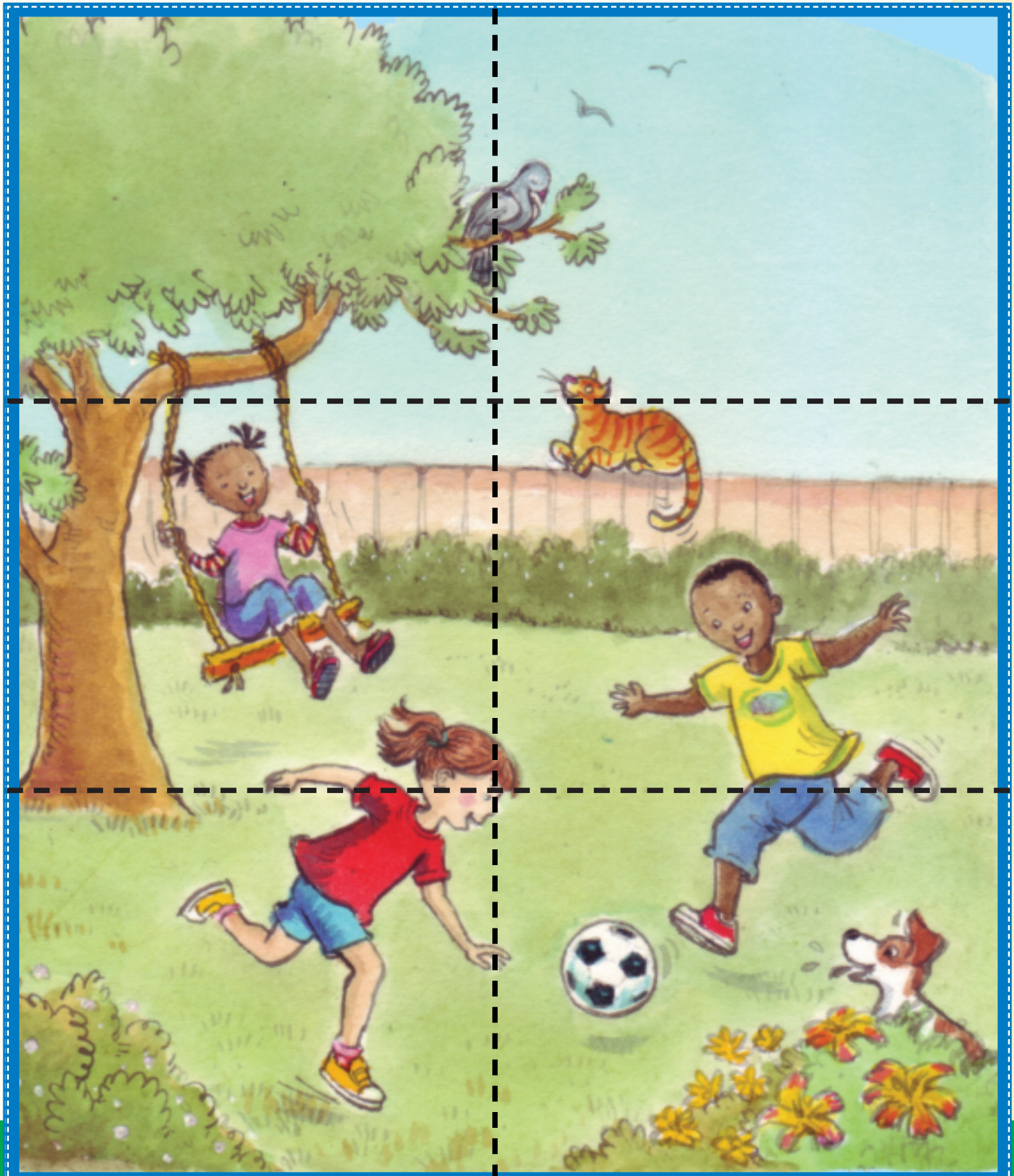

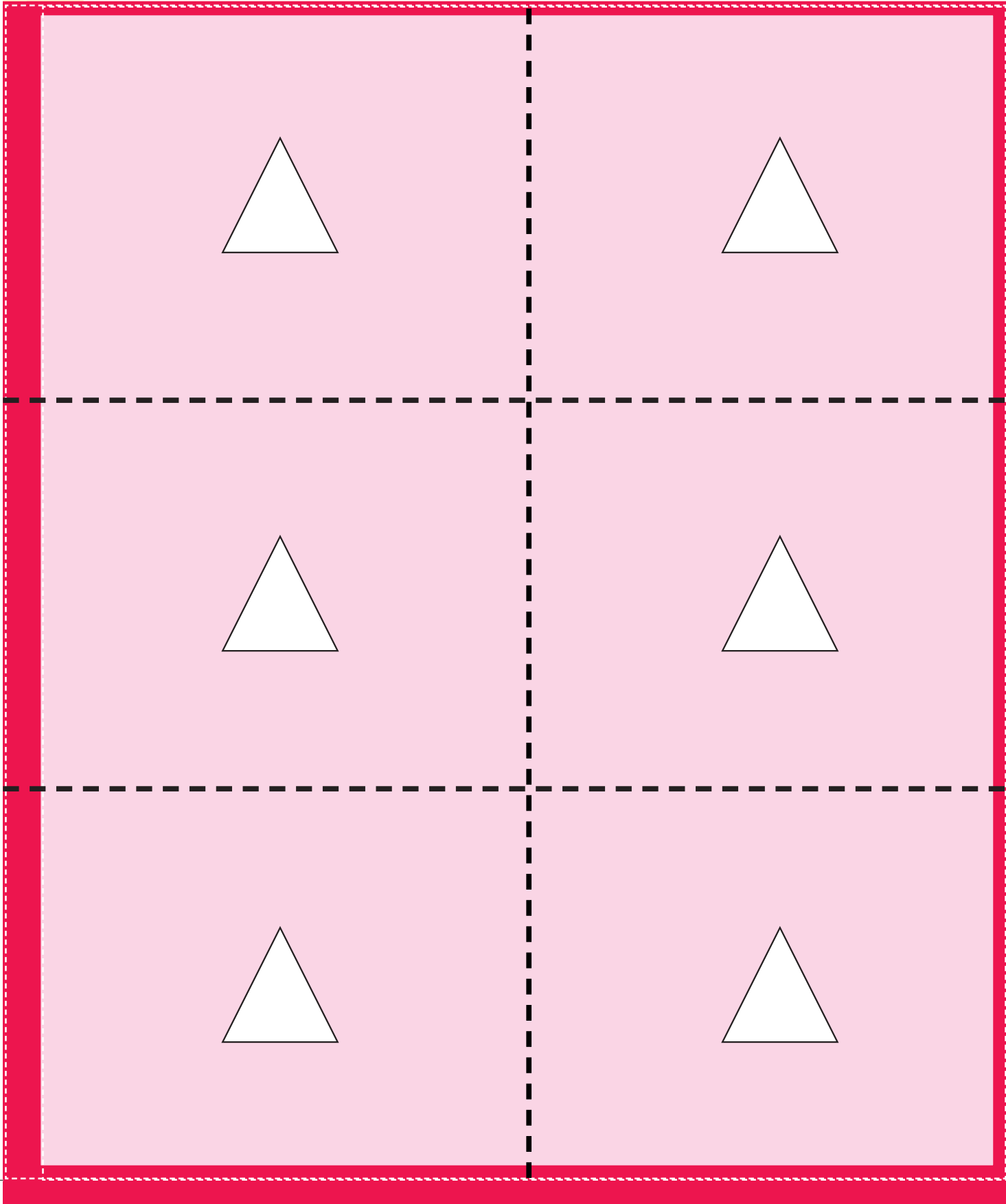
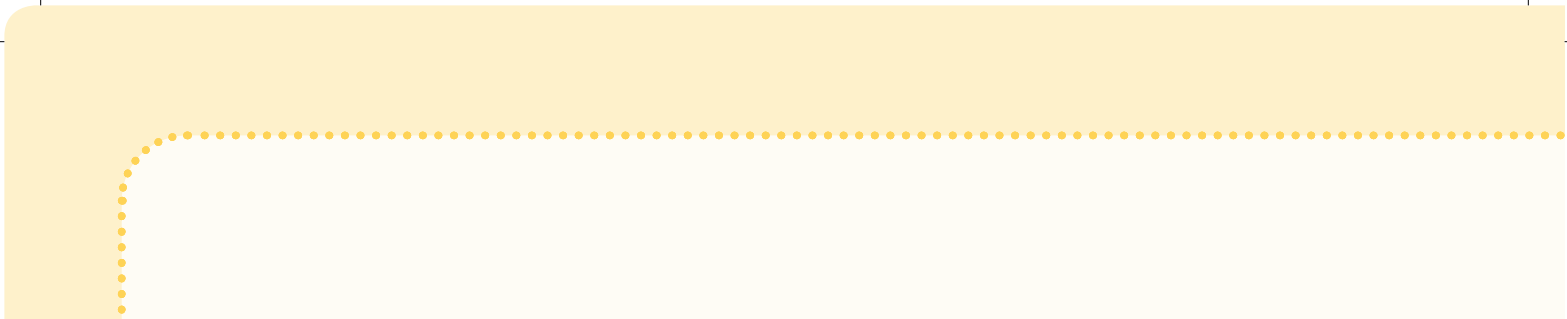



Latela methalo ya marothorotho go ripa seswantšho gomme o latelanye ditiragalo.



3

2

1

3

2

1

4.6



Balela, mamaretša o be o gatišetše dinomoro.

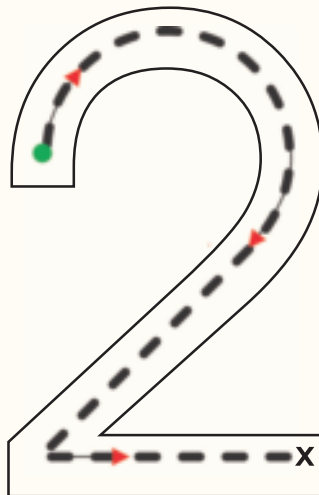
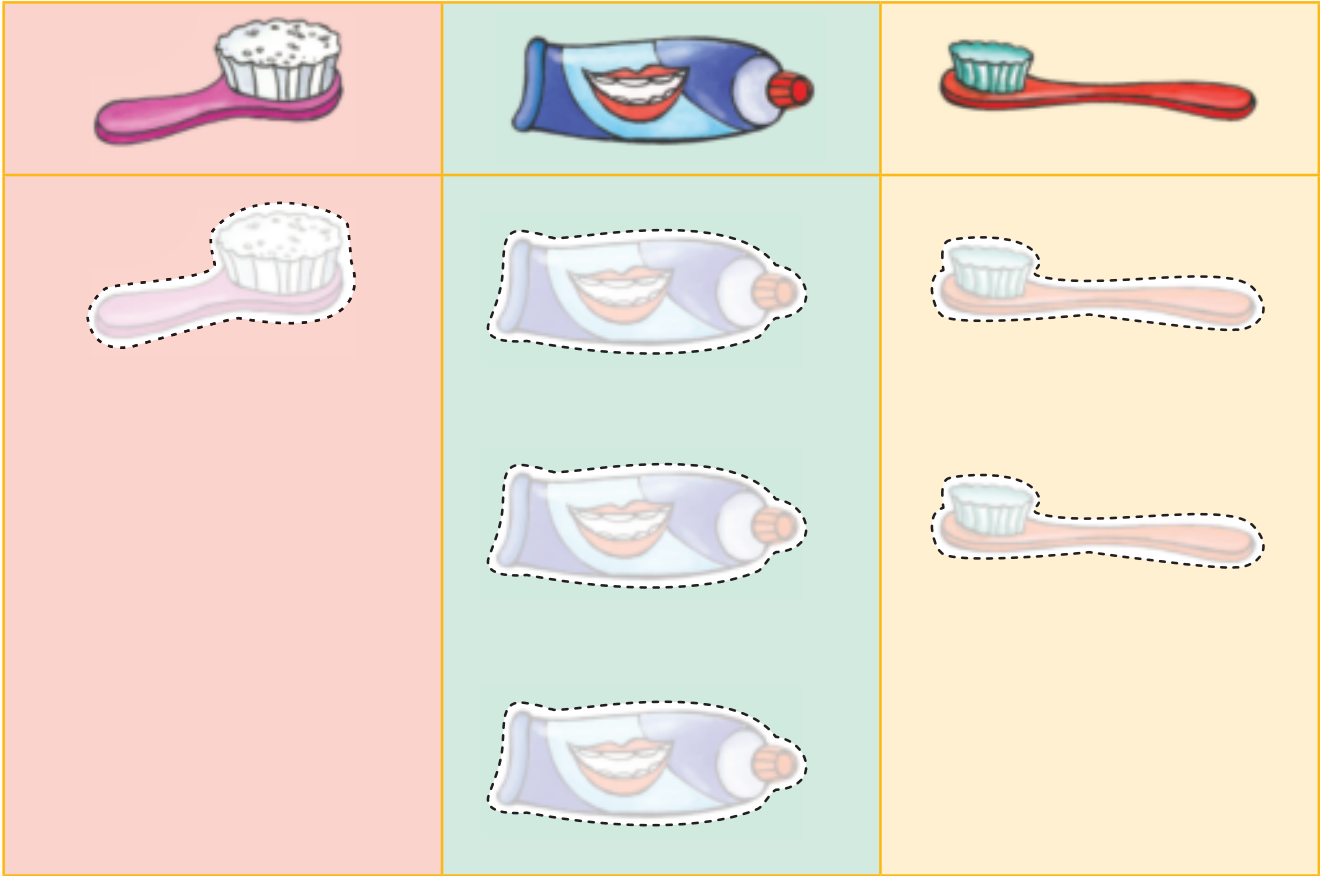

5

Bagwera

Ahlaahla seswantšho o be o mamaretše dimamaretšwa.

Kotara ya 1 – Beke 6–10



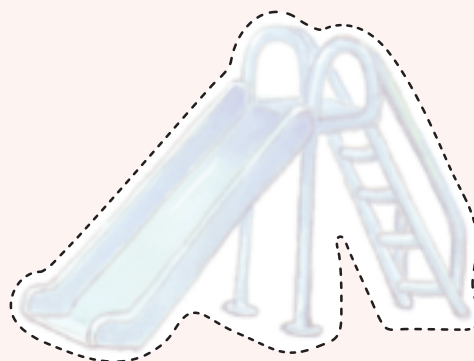



Raretša seswantšho seo se swanago le sa ka lepokising la mathomo.





Lemoga le go laetša phapano mo diswantšhong.





Gatšetša o be o nyalanye seaparo le mong wa sona.

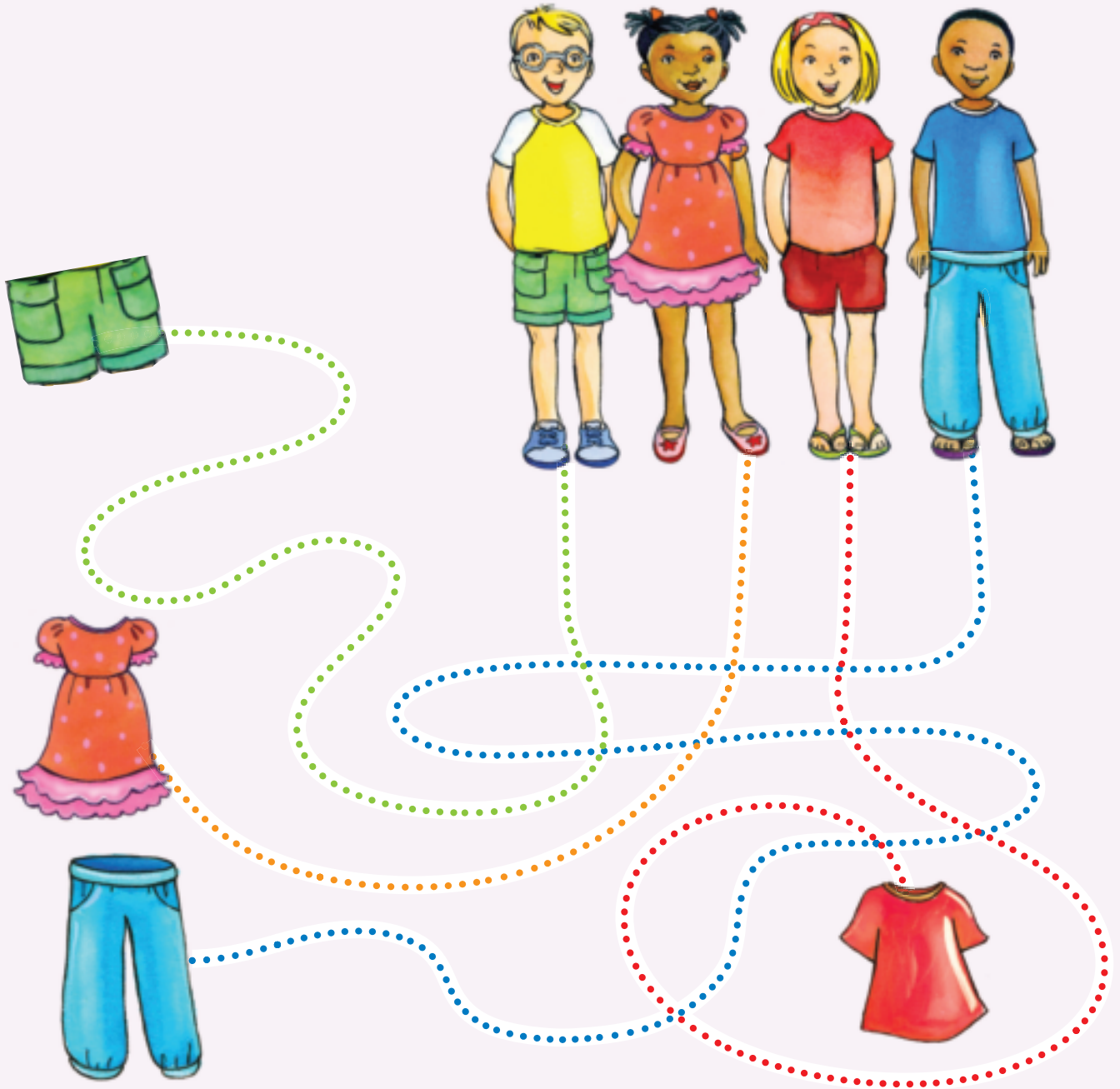

5.4



Mamaretša, o be o bolele gore ke tše kae.

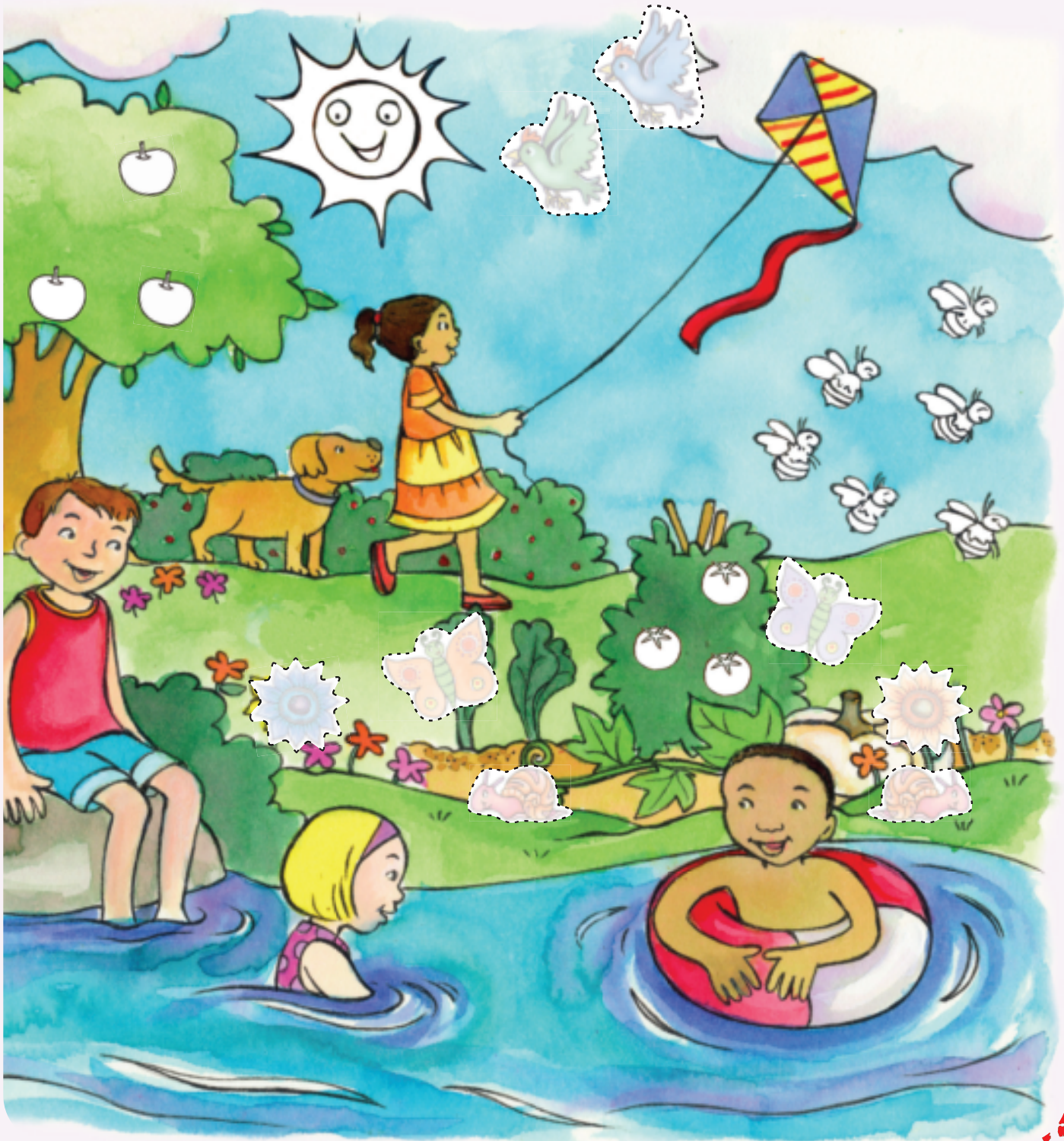



Raretša dilo tšeo di re botšago ka selemo.



5.6



Bolela ka seswantšho sa ditiragalo tša selemo o be o mamaretše dimamaretšwa.

fiša

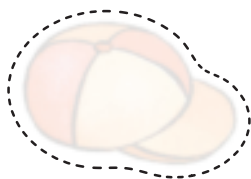
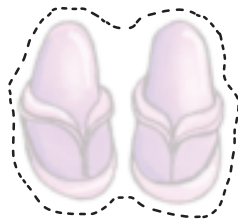
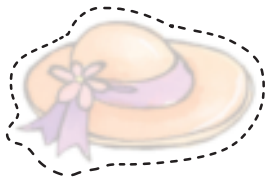



Bolela ka seswantsho sa ditiragalo tša marena o be o mamaretše dimamaretšwa .

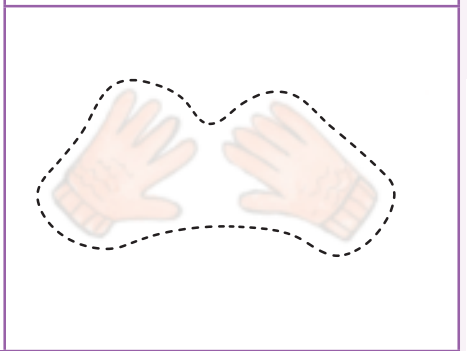
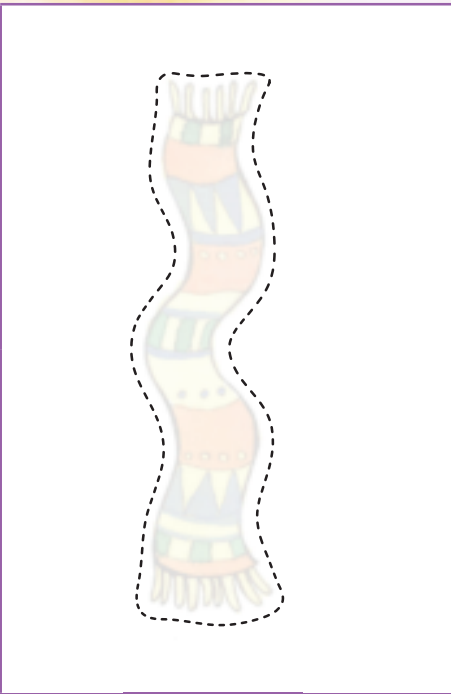

5.8



Sega, o be o mamaretše marungwana.

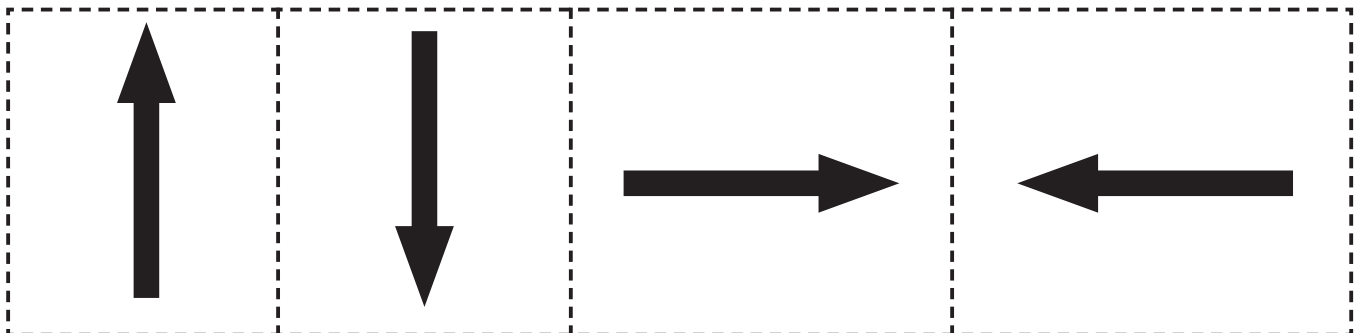
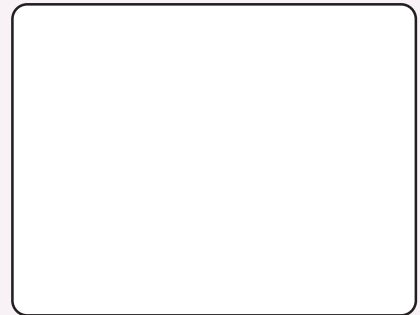



Disegwa



Diphaphethe tša menwana:

Kgetha phoofolo e 1 gomme o ngwale tlhaka ya mathomo ya leina la gago mo go sekipha sa yona. Ka morago o ngwale ditlhaka tša mathomo tša maina a bagwera ba gago ba 4 mo go tše dingwe.



Phasele ya dinomoro:

Sega mo go methalo ya marontho go dira dikarata tša go nyalanya dinomoro. Ka morago o nyalanye diswantšho le dinomoro tša maleba, goba le palo ya maleba ya marontho. O ka no šomiša dibopego gore di go thuše.

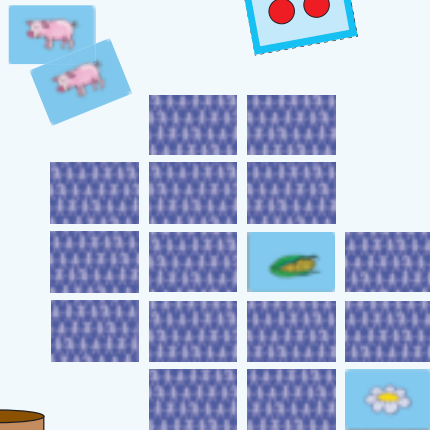

Papadi ya go elelwa:

Hlakahlakanya dikarata gomme o di pake godimo ga tafola, o di ribegile. Ka morago ga moo o phethole dikarata, tše pedi ka nako e tee. Gae di nyalana, o ka di beela ka thoko. Gae di sa nyalelane gona di bušetše. Bona ge eba o ka gopola gore o di beile kae.

Wa mathomo wa go hwetša diphere tša di nyalelanago ke mofenyi. Le ka raloka le sekaki ka tšona dikarata tše.

Diphoofolo tša go dirwa ka dithoeleterolo:

Nyaka dithoeleterolo tše di fedilego. Sega dikhutlonne, ka morago o mamaretše ditsekana tša dikhutlonne tše kgolo go dikologa dithoeleterolo go khupetša ditšhupu. Bjale, sega hlogo gomme o e mamaretše mo go dirolo kua godimo. Šomiša dimamaretšwa tša diphoofolo gomme o mamaretše sefahlego mo hlogong go ya le ka mo o ratago ka gona. Mamaretša matsogo, maoto le mosela mo go phoofolo ye nngwe le ye nngwe ye e lego mo go dirolo. O ka no thala le go ipopela diphoofolo tša gago.

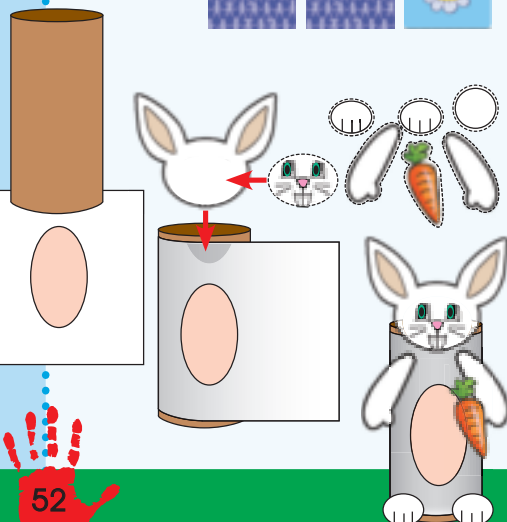

Dira dipuku tša manyokenyoke.
Di phuthe mo go motšhalo wo mokoto
gomme o di sege metšhalong ya marontšho.



Dinomoro

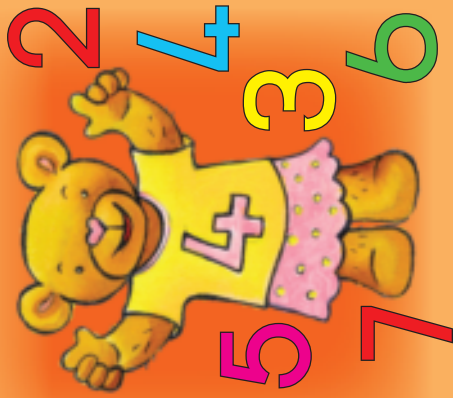

Diruiwaratwa



1



tee



mpša

2

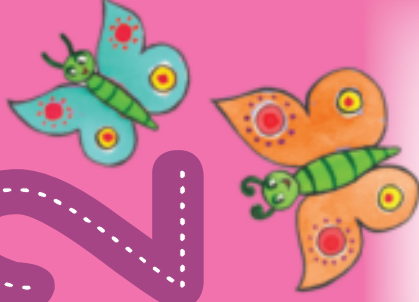

pedi



katse

3



tharo



hlapi

mokgaritswana



nne

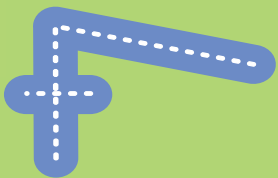

nonyana

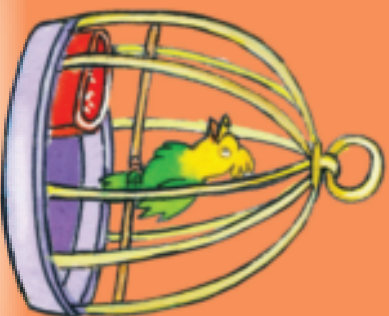

hlano



hemsta



tshela

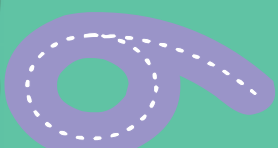

mmutlanyana



šupa

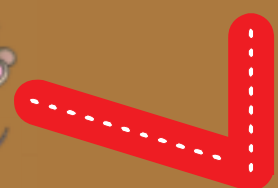



DISEGWA TŠA KA



A re direng

Sega letlakala mo go mothaladi wa marontho ka morago o mamaretše letlakala leo mafelelong a puku gore o dire kanapa. Bea disegwa tša gago ka gare ga kanapa ye gore di se ke tša timela.

MAMARETŠA MO

MAMARETŠA MO

MAMARETŠA MO

MAMARETŠA MO

FOLD

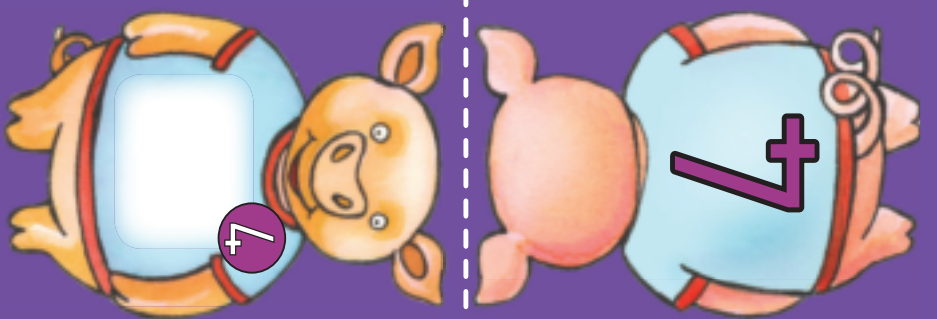

- 0
- 1
- 2
- 3
- 4
- 5
- 6
- 7
- 8
- 9
- 10
- 11
- 12
- 13
- 14
- 15
- 16
- 17
- 18
- 19
- 20
- 21
- 22
- 23
- 24
- 25
- 26
- 27
- 28
- 29

a b c d e f g h i j k l m n o p q r s t u v w x y z



0	a	1	b	2	c	3	d	4	e	5	f	6	g	7	h	8	i	9	j	10	k	11	l	12	m	13	n	14	o	15	p	16	q	17	r	18	s	19	t	20	u	21	v	22	w	23	x	24	y	25	z	26	27	28	29
---	---	---	---	---	---	---	---	---	---	---	---	---	---	---	---	---	---	---	---	----	---	----	---	----	---	----	---	----	---	----	---	----	---	----	---	----	---	----	---	----	---	----	---	----	---	----	---	----	---	----	---	----	----	----	----

GLUE HERE

GLUE HERE

GLUE HERE

GLUE HERE

GLUE HERE

GLUE HERE

GLUE HERE

GLUE HERE

GLUE HERE

GLUE HERE



1

1

2

2

3

3

4

4

5

5







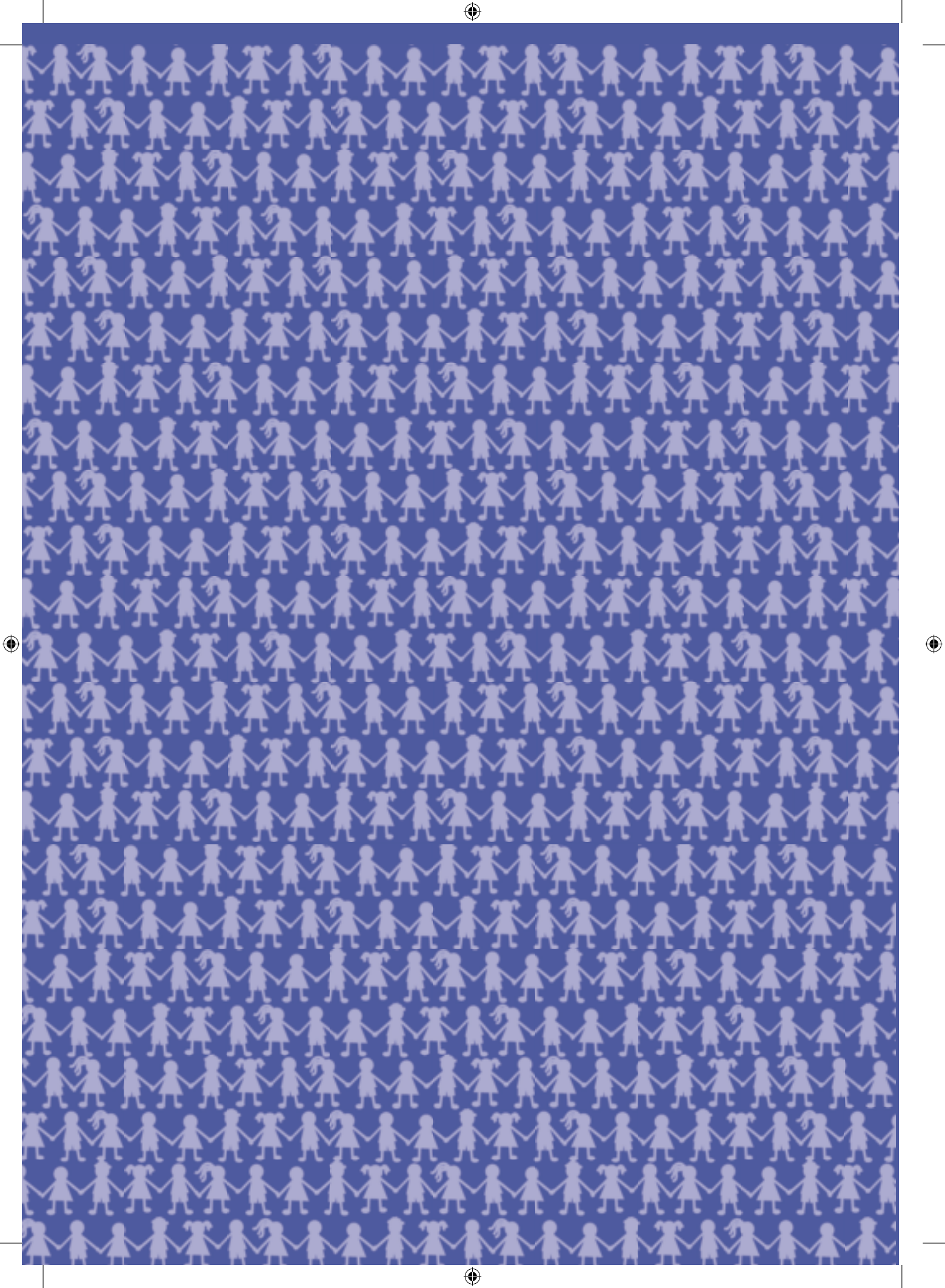

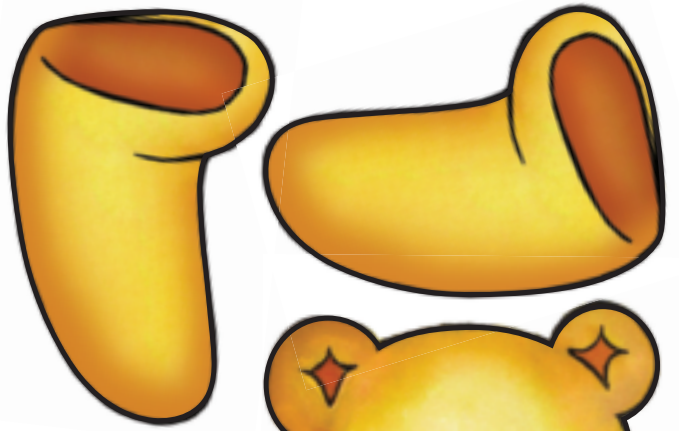
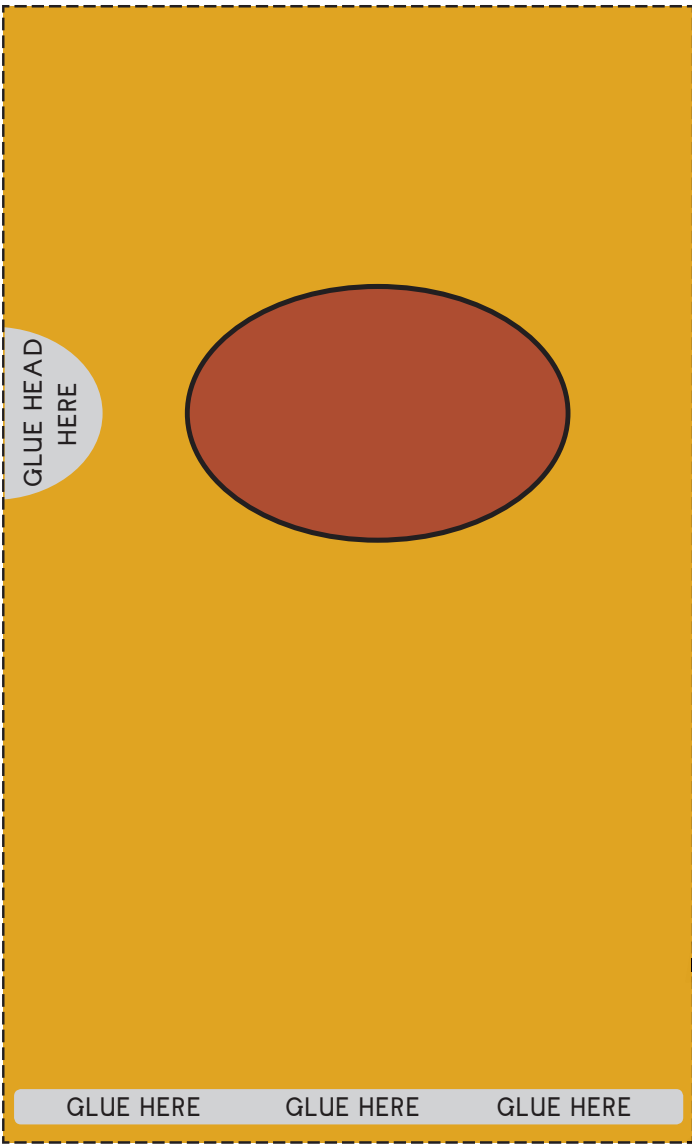

TEDDY BEAR

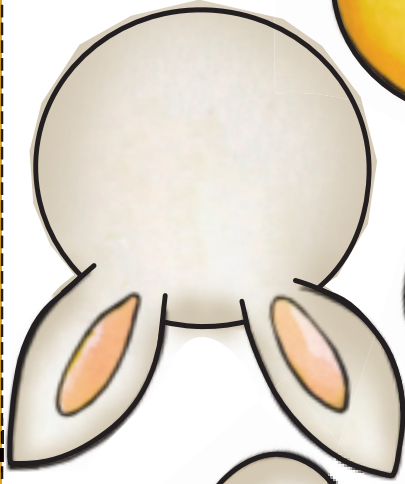

RABBIT

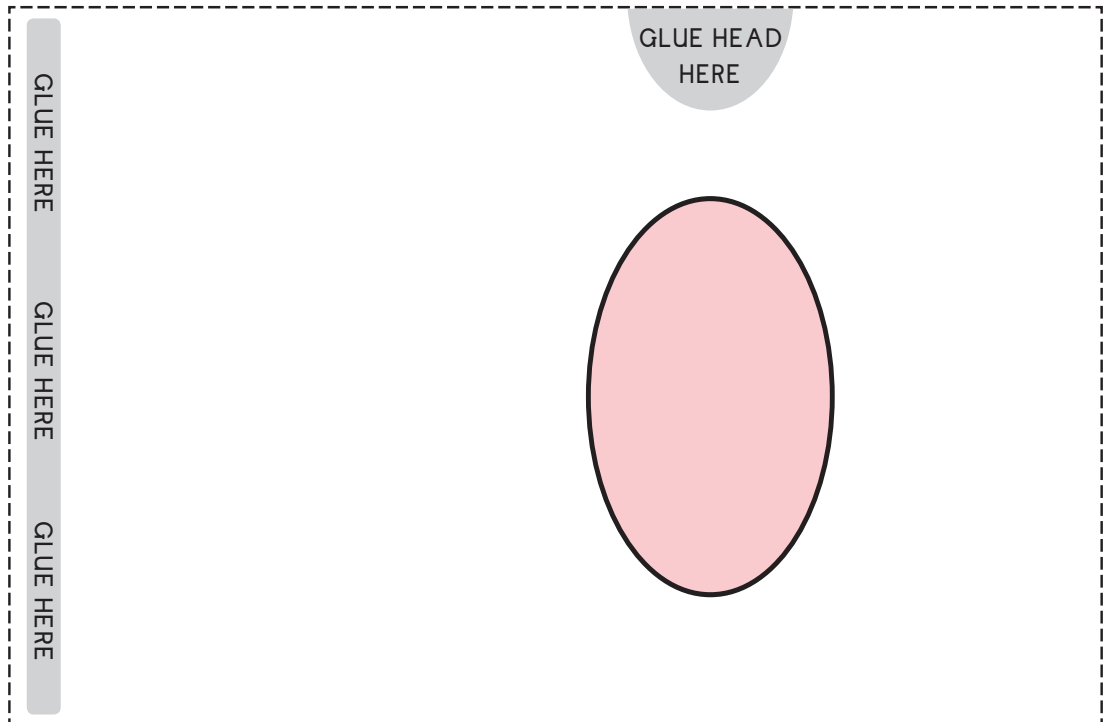

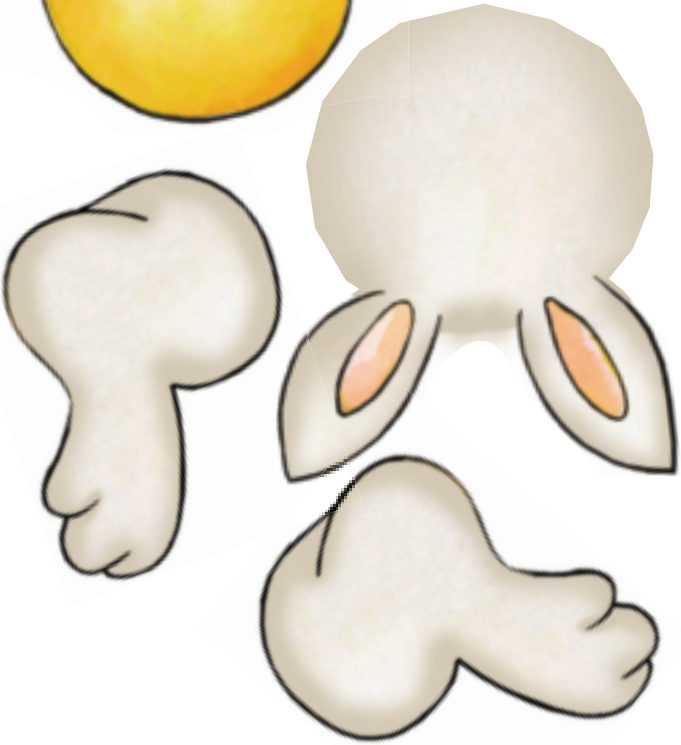
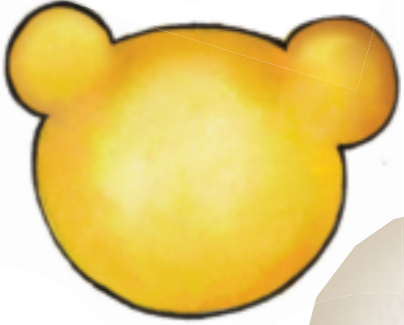
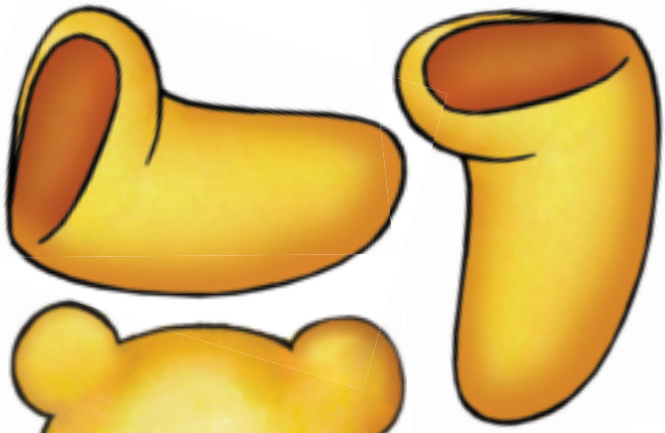

STICKERS

GRADE R BOOK1

8



6



12



20



30

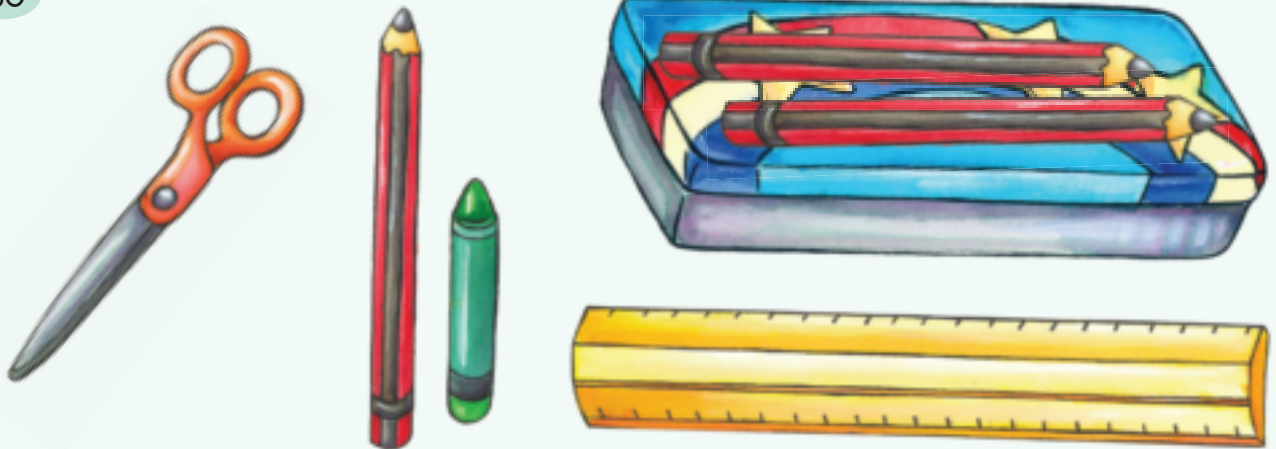

31



43



47



49-50



TEDDY BEAR

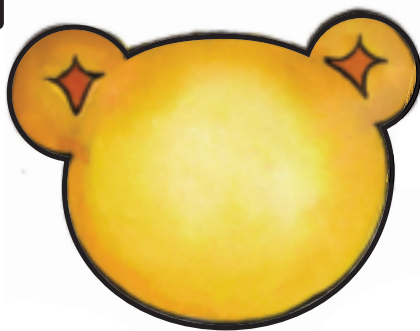

ARMS

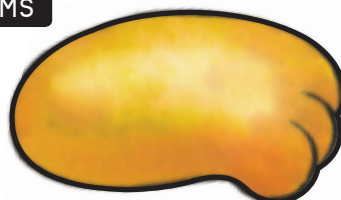
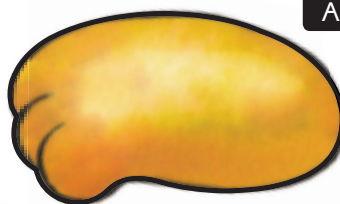

NOSES & MOUTHS

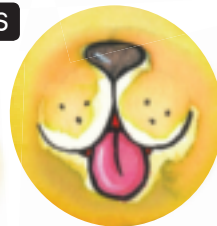

TAILS

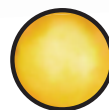
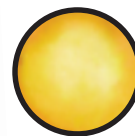

EYES

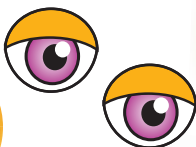

FACES



ARMS

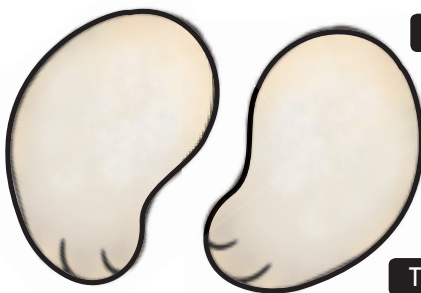

TAILS



EYES



FACES

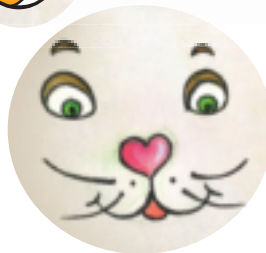

RABBIT

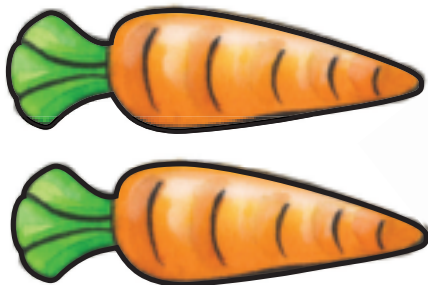

12

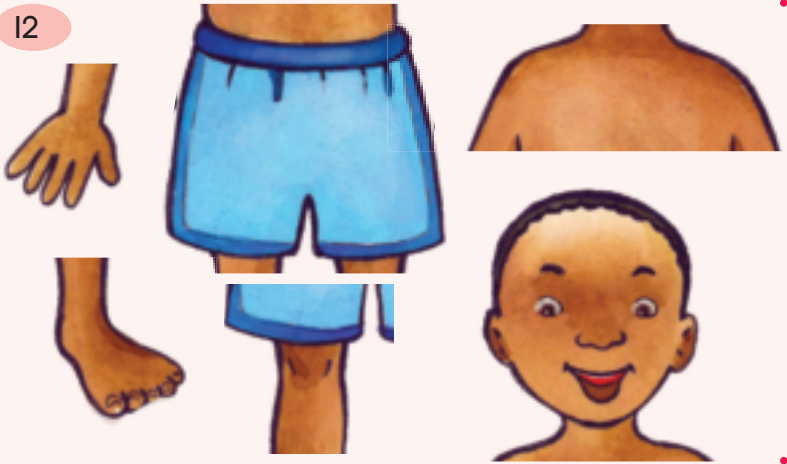

33



30



41

