



SISWATI
 GRADE R – BOOK 1
 TERM 1
 ISBN 978-1-4315-0697-2
 THIS BOOK MAY NOT BE SOLD.
 14th Edition



Libanga **R**



Kubuyeketiwe futsi
 kwahlelenjiswa
 ngekwema-CAPS

Ligama:



SISWATI
 Incwadzi
 —
 Ithemu!



*Nkhsht. Angie Motshekga,
iNdvuna yeMfundvo
yeSisekelo.*



*Dkt. Reginah Mhaule,
Liphini leNdvuna
yeMfundvo yeSisekelo.*

LeTincwadzi-tekusebentela takaRainbow (Libanga R) emnyakeni weSendvulelo tiyincenye yemasu netinhlelo teLitiko leTemfundvo yeSisekelo kuhlomisa bantfwana besikolo beNingizimu Afrika ngemakhono esikolo. Luphenyo-njulo selukhombisile kutsi umnyaka ngamunye bantfwana labawucitsa benta imisebenti leshukumisa ingcondvo embi kwekucala Libanga 1, ibenta basebente kancono kabi esikolweni eminyakeni lelandzelako – sigaba sonkhe semfundvo lephansi nalephakeme. Ngako-ke, lomklamo wekubeka sisekelo lesicinile eBangaeni R ucondzene naleto tinzuzo.

Luhlelo-mfundvo lweMkhakha weSisekelo lubheke kutsi bafundzi beLibanga R baniketwe ematfuba ekutfufukisa emakhono abo esendvulela-kufundza, sendvulela-kubhala nesendvulela-tibalo, lubuye lwendlale kabanti emakhono labatawadzinga kuba nesisekelo lesisimeme semfundvo kute bakutfole kungesimatima kufundza eBangaeni 1 kuya embili.

Ngako-ke, leTincwadzi-tekusebentela teLibanga R tihlose kusita bantfwana ekutfufukiseni lamakhono kanye nelwatinjulo labataludzinga kwendlala sisekelo lesisimeme ekufundzeni kwabo. Tiyansinsa nje ngematfuba lavumela bantfwana bacije emakhono abo basalungela kungena sikolo emabangaeni letako.

Ngembi kwekutsi bantfwana bafundzise kahle kufundza, badzinga kucatfuliswa ngekutsi batfole kutsi yona incwadzi ibanjwa njani, emakhasi ayo aphenywa njani vele. Futsi badzinga kucondzisa kutsi tincwadzi tisebenta kanjani. Badzinga kucondza budlelwane lobukhona emkhatsini wemagama netitfombe encwadzini babuye babone kutsi phela emagama lasekhasini akhiwe ngemisindvo futsi asho lokutsite. Kanjalo, ngembi kwekutsi bantfwana bafundze kubhala, kufute baceceshwe kuhanjiswa kwesandla nemisipha yaso, batowufundza kwakha bobunjwa bachubekele ekwakheni emagama. Lawa ngiwo ngco lamakhono lahloswe kuceceshwa nguleTincwadzi-tekusebentela.

Sonkhe siyati kutsi bantfwana abafundzi ngesivinini lesifanako. LeTincwadzi-tekusebentela teLibanga R tenta kukhonakale kutsi bothishela basebente ngesivinini semfundzi ngamunye kuye ngekuphiwa kwakhe kutsi nakunesidzingo, baye emuva nasembili ngencwadzi, balawulwa likhono nesimo semntfwana ngamunye. Lemisebenti itawubuye isite bothishela ekuboneni tihibe letivimbela bantfwana ekufundzeni kahle khona leti tihibe tingasonjululwa ngembi kwekutsi umntfwana angene esikolweni ebangaeni lekucala.

Tincwadzi-tekusebentela tiyinhlanganisela yekufundzisa kufundza nekubhala, kubala nemakhono emphilo lokwetfulwe ngetingcikitsi letingema 20 kusetjentiswa tindlela letijabulisako naletihehako kudvonsa bafundzi labasakhula kutsi bente imisebenti. Siyetsemba kutsi bafundzi bakho batayitsakasela lemisebenti lekulencwadzi basakhula nekufundza sikolo, nanekutsi kwanawe njengathishela wabo utatitika kanye nabo ebananzini lobuphetfwe ngulencwadzi.

Kusebentisana



Kwakha iphazili...



basic education
Department:
Basic Education
REPUBLIC OF SOUTH AFRICA



Sponsored by
OMO

SCAN HERE
or visit OMO.CO.ZA
for fun activities in
the OMO Messy
Play Zone.





yelibanga **R** INHLANGANISELA

- Lulwimi lwasekhaya
- Tibalo
- Emakhono ekuphila

1	Ngimi lo	2
2	Umtimba wami	12
3	Eklasini	24
4	Imphilo lenhle	32
5	Bangani	42

SISWATI

Incwadzi



Ithemu 1



Ngimi lo



Tsatsisa.

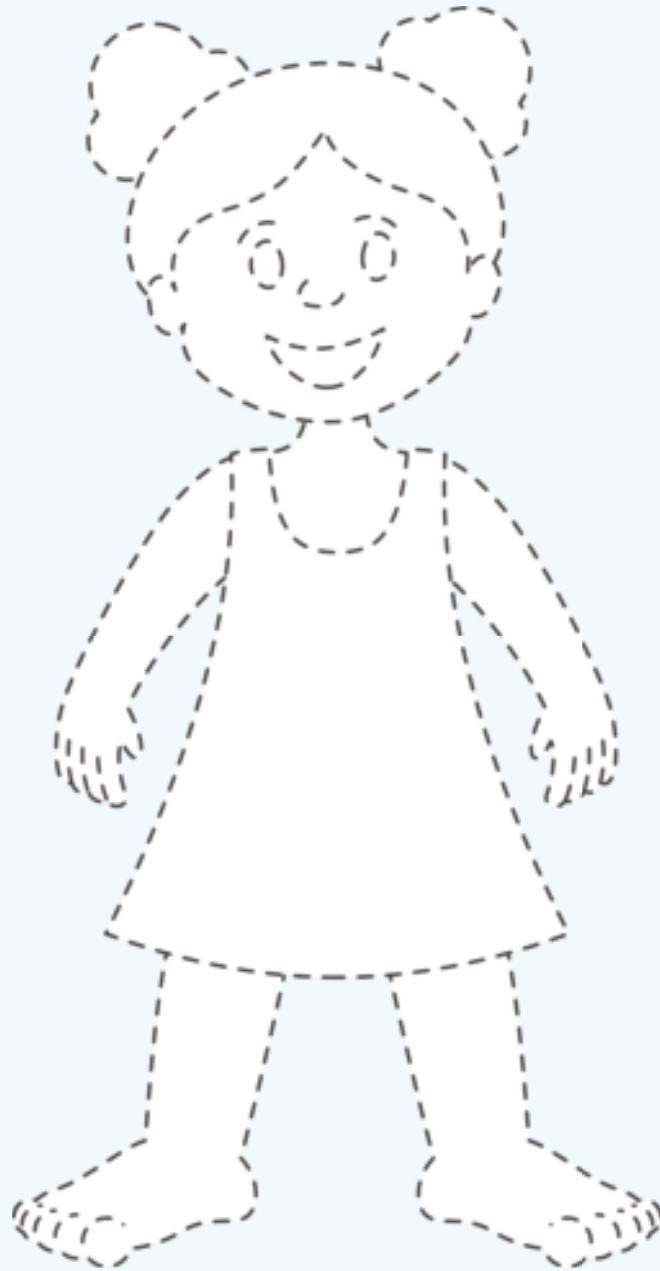

Intfombatane

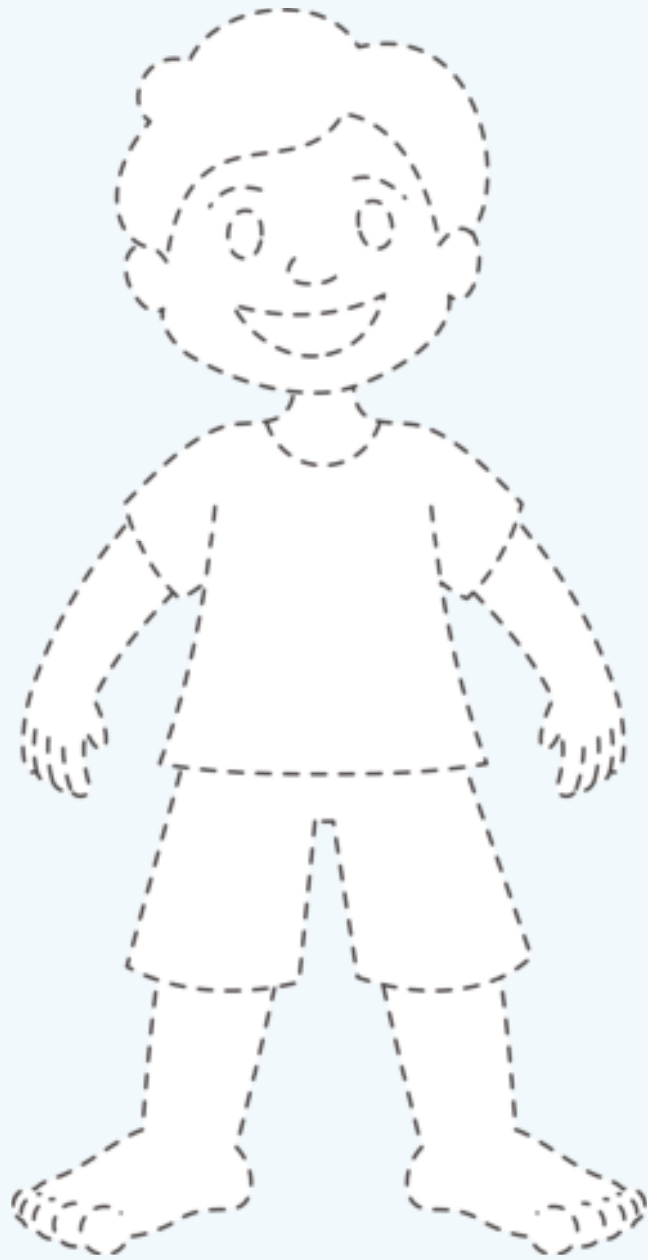

Umfana



Tidvwebe.

1.2



Biyela kukhombisa iminyaka yakho.

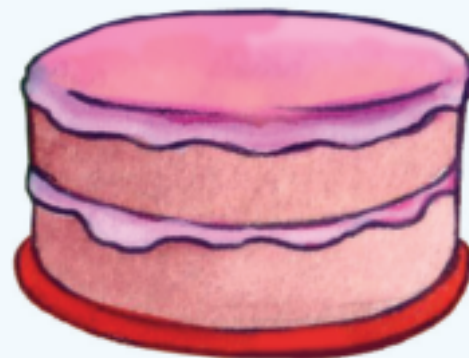
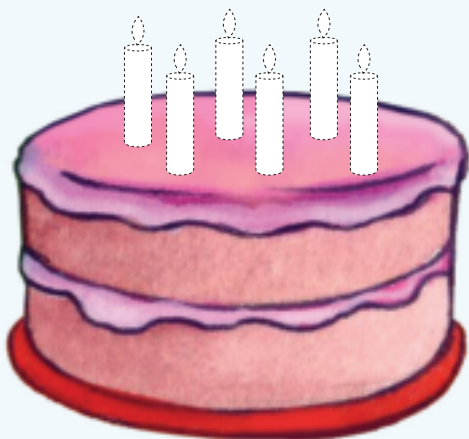

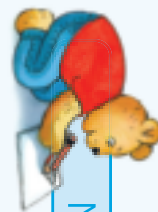
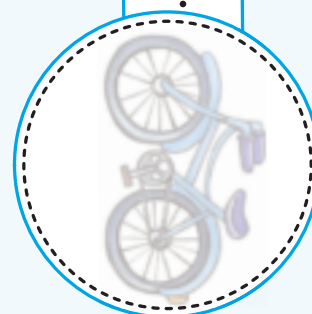
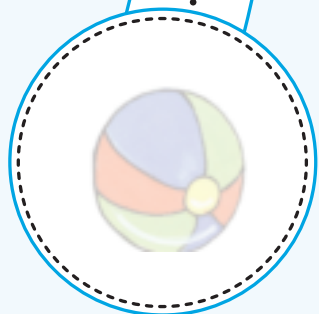
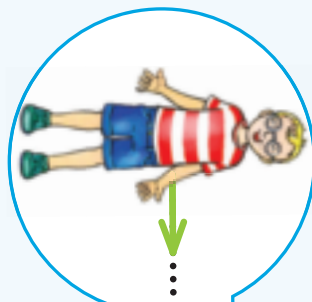

Nameke ubuye utsatsisa.



Sebentisa luphawu ✓ kukhetsa umbala wemehlo netinwele takho.

Umbala wemehlo ami

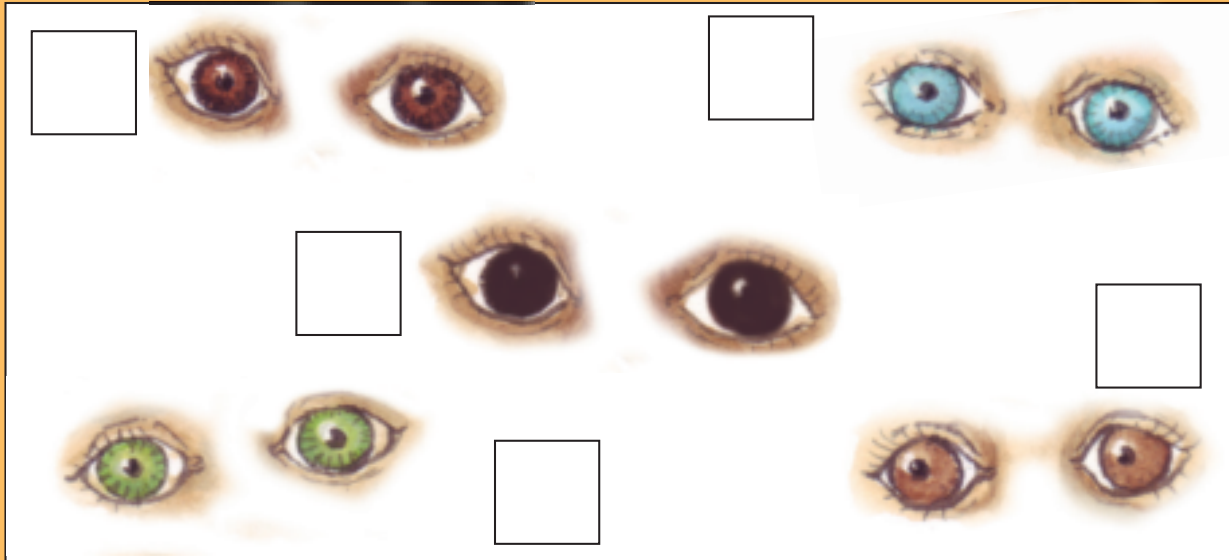

Umbala wetinwele tami

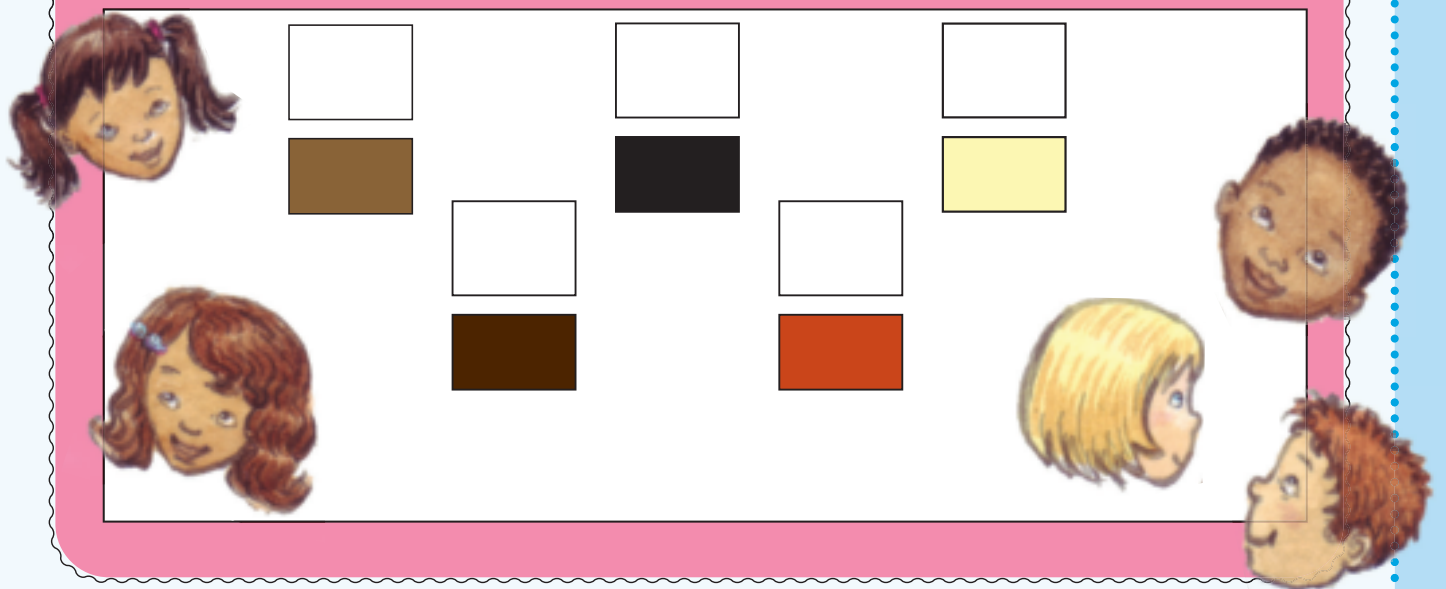



1.5



Dvweba buso bakho.

Ithemu 1 – Liviki 1–5





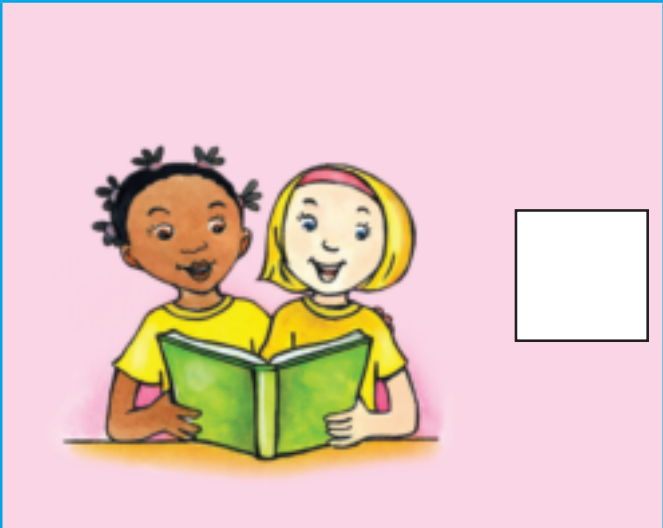
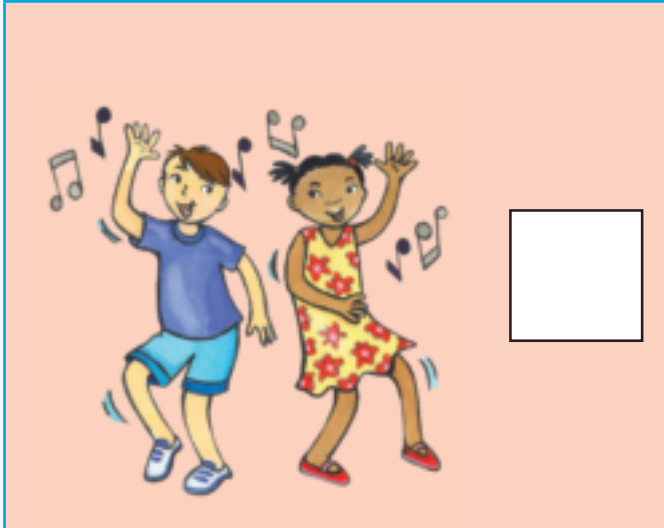

Coca ngalokutsandzako.











Condzanisa letitfombe.



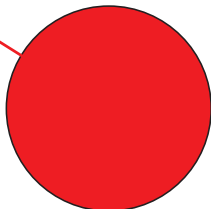





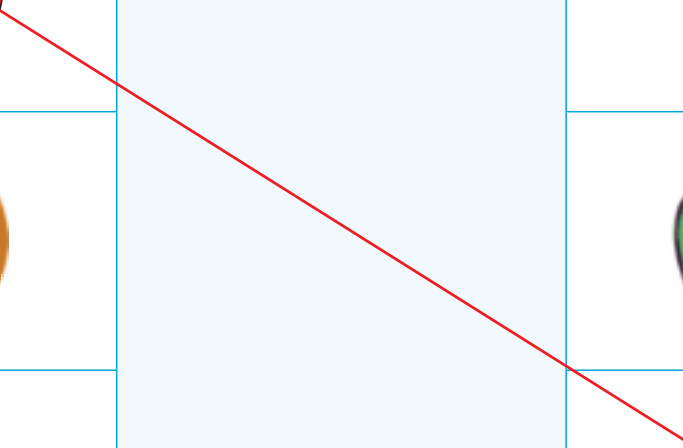





Biyela libhokisi lelinentfo yinye. Tsatsisa inombolo 1.



2

Umtimba wami

Ithemu 1 – Liviki 1–5



Asikhulume sinameke
lokungekho kulomtimba.



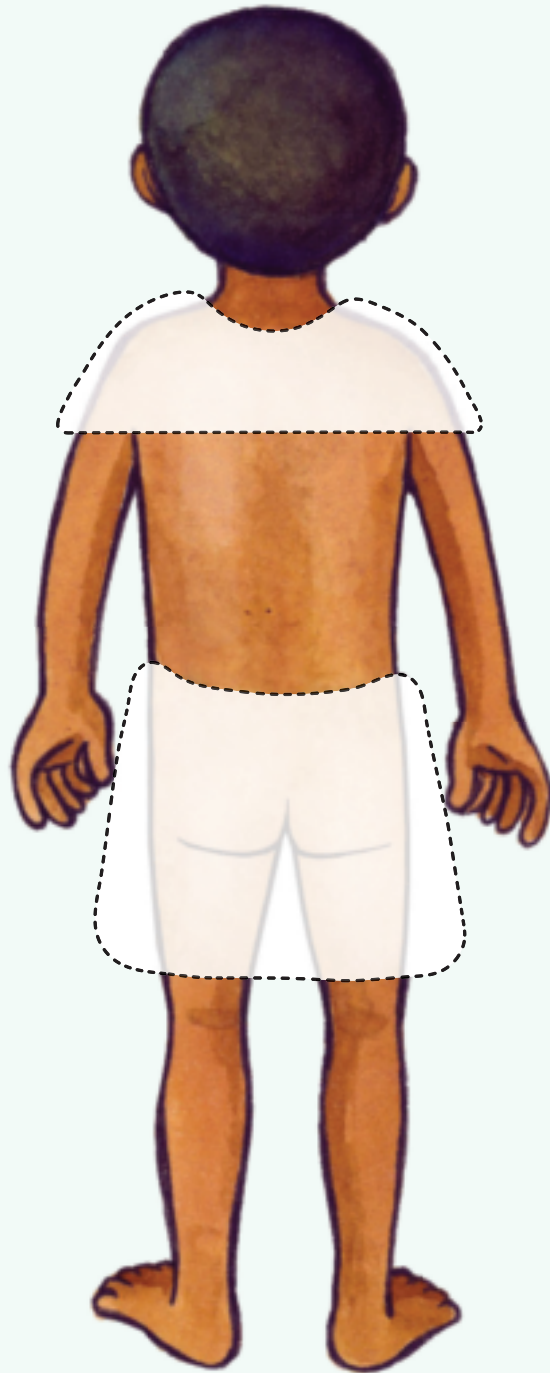

2.



Tsatsisa ufake imibala lengenhla.

Ithemu 1 – Liviki 1–5

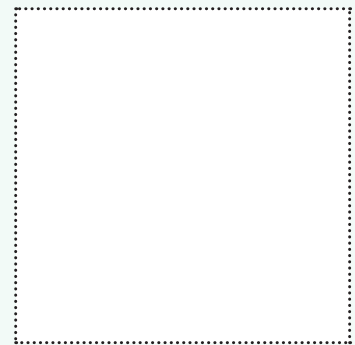
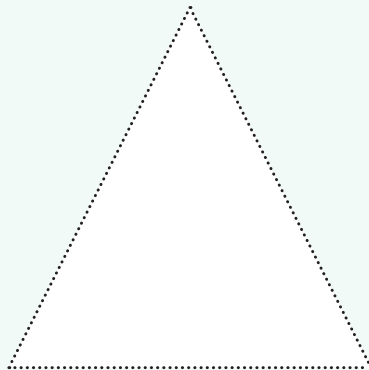
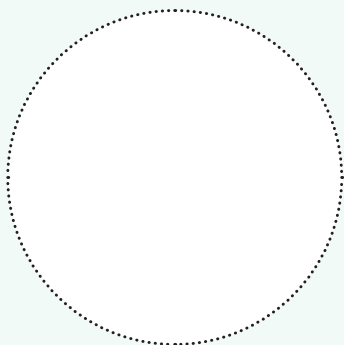
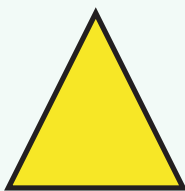
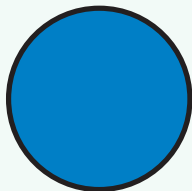
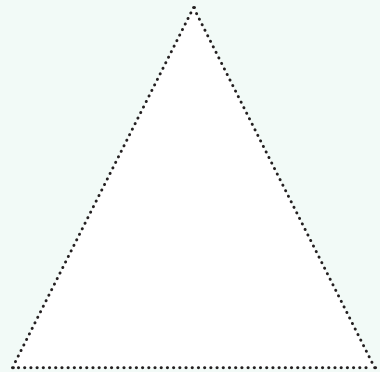
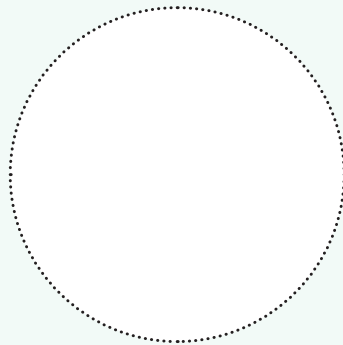
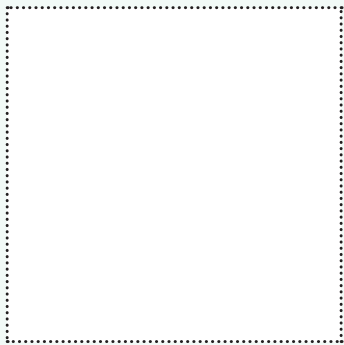
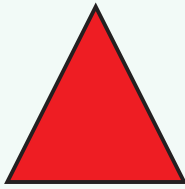
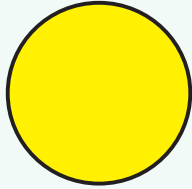
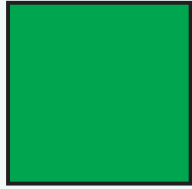

2.2



Goca emkhatsini.

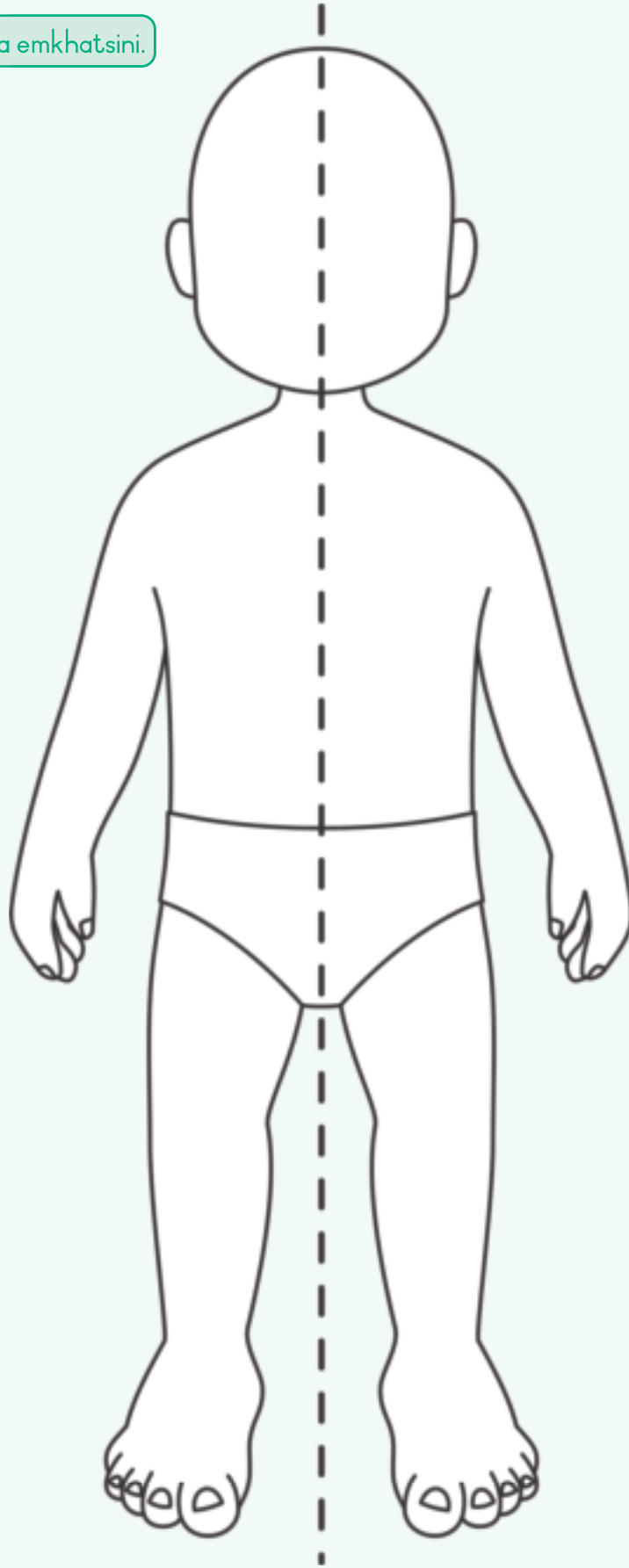

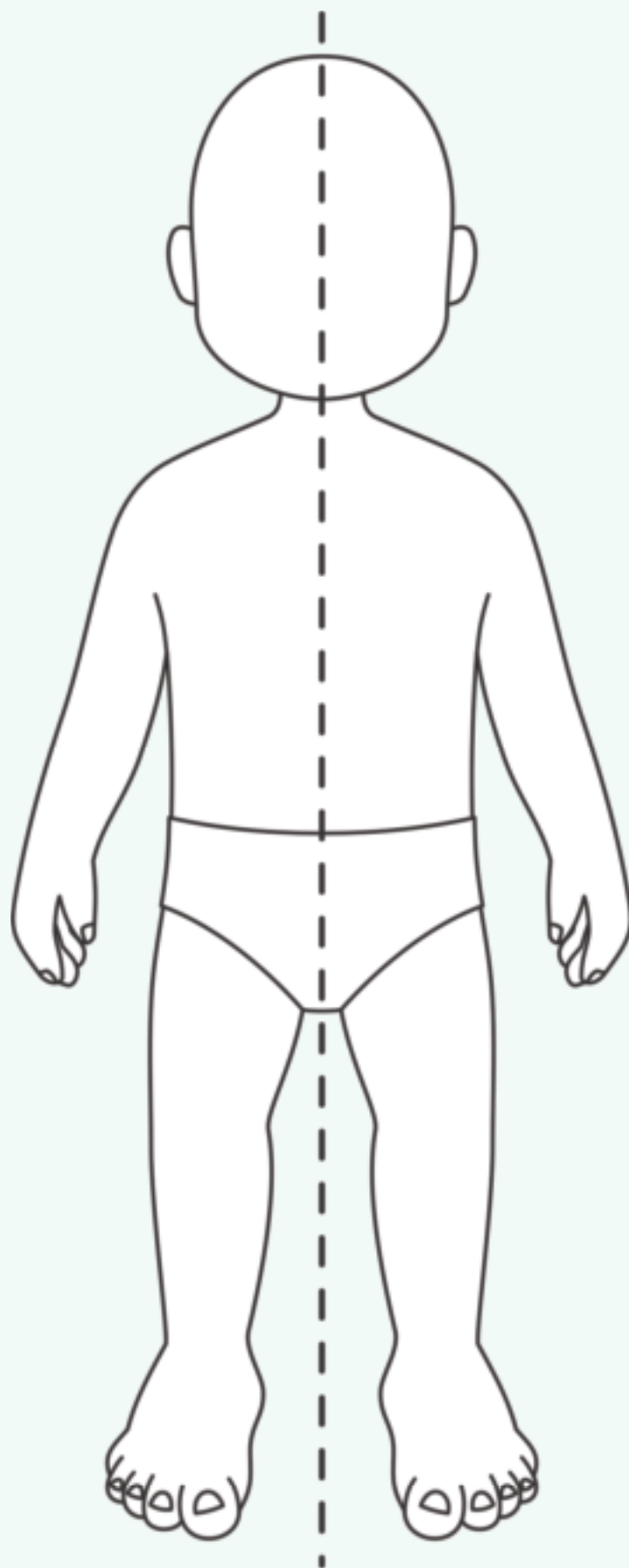

2.3



Sika unameke ngalokuf anele.

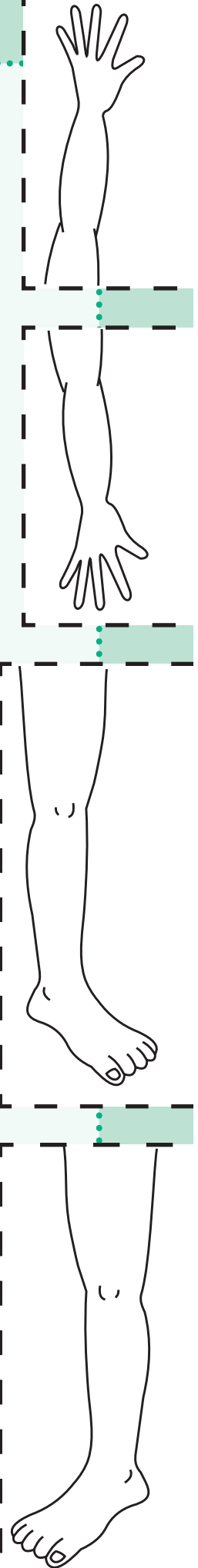
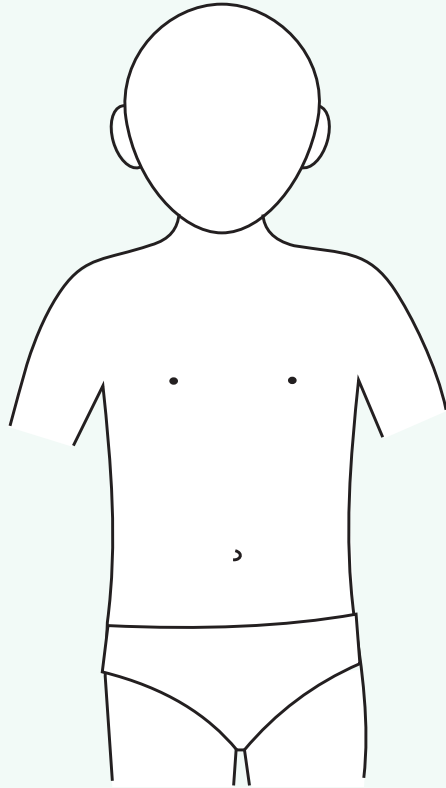

2.4



Tsatsisa sandla sakho.

A large, empty rounded rectangular box for drawing or writing.



Tsatsisa minwe yakho.

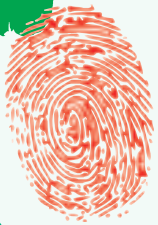

A row of five empty rounded rectangular boxes for drawing or writing.





Coca ngekulanzelana kwetigameko tasekuseni.

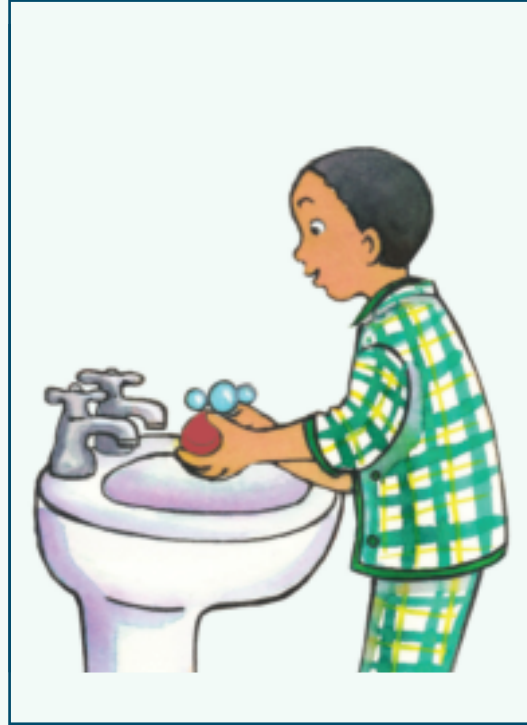

2.6



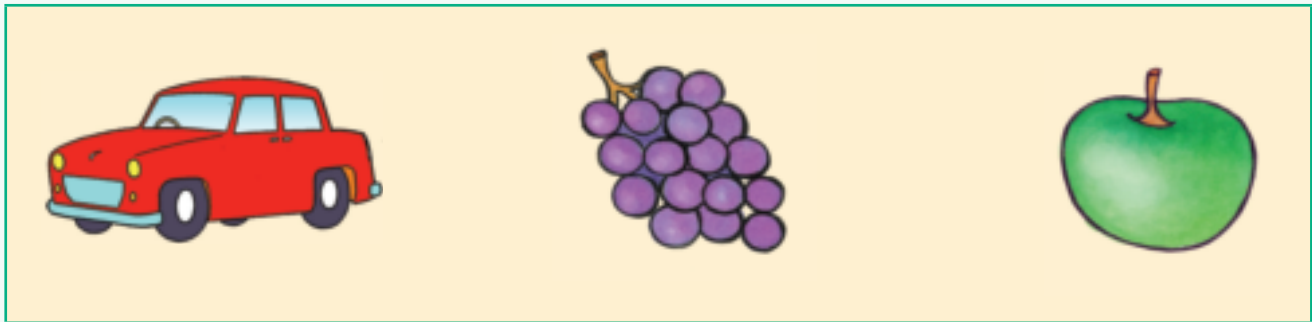
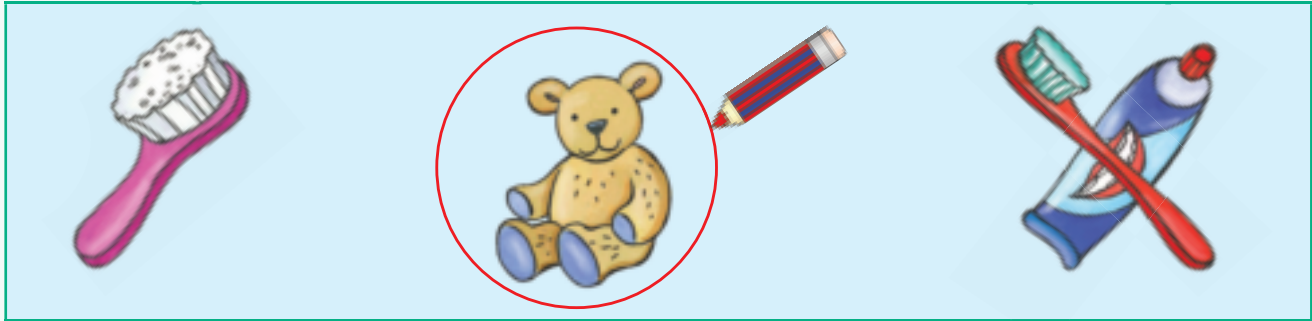

Biyela lokungahambisani nalokunye.







Biyela buso lobuf ana nalobo lobusekucaleni.

	
---	--

	
---	---

	
---	--



Tsatsisa ulandzele iphethini.

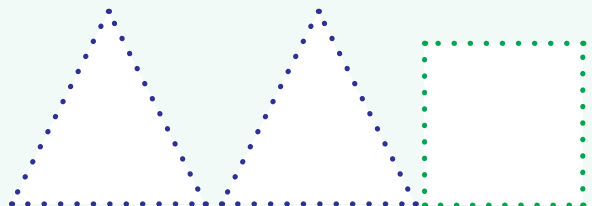
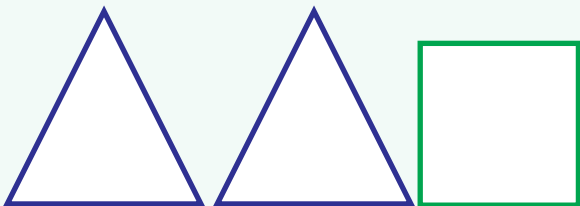
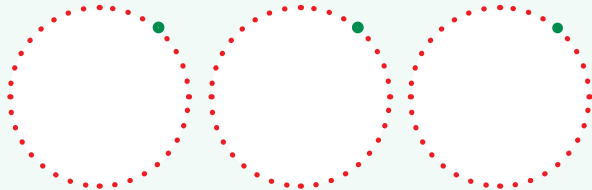
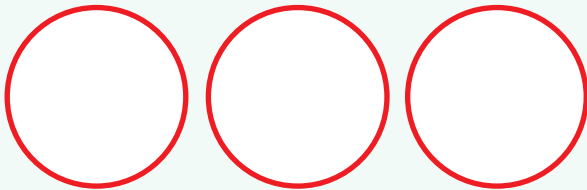
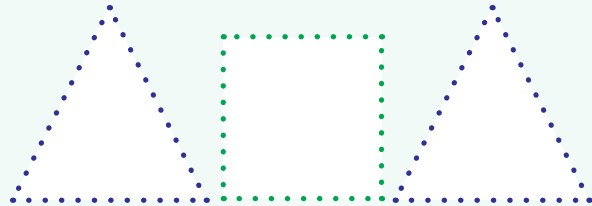
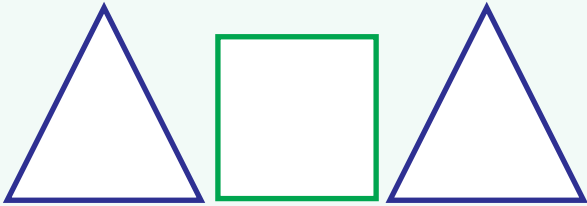
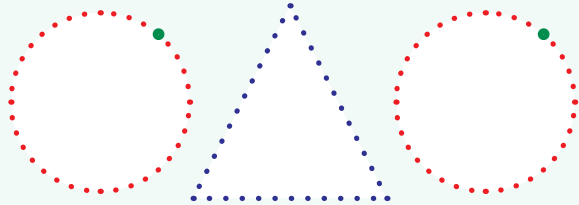
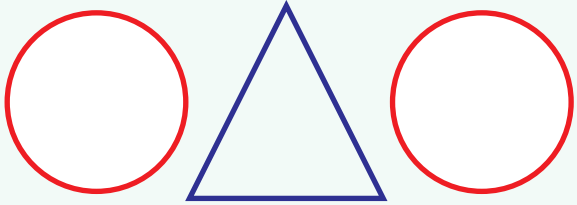

Eklasini

Asikhulume.





3.1



Tsatsisa, faka ✓ luphawu entsanjeni lendze. Ubiyela lemfishane.

Ithemu 1 – Liviki 1–5

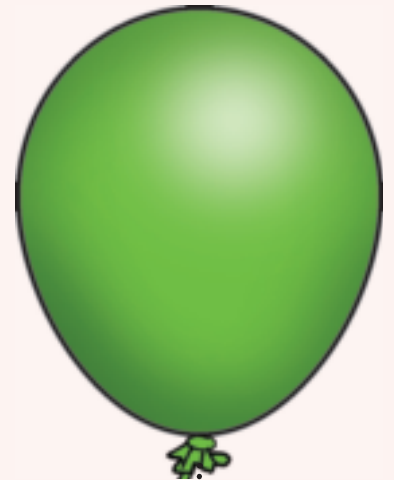
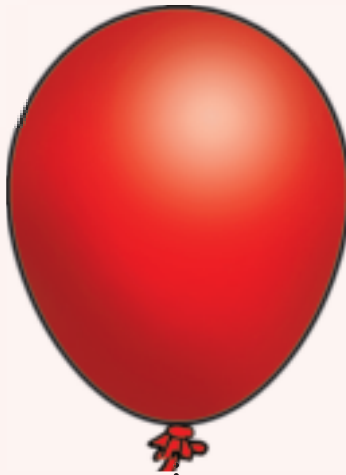
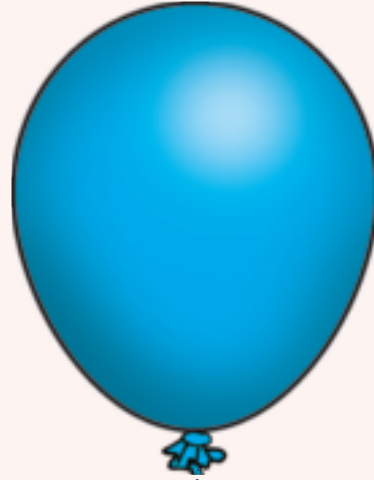
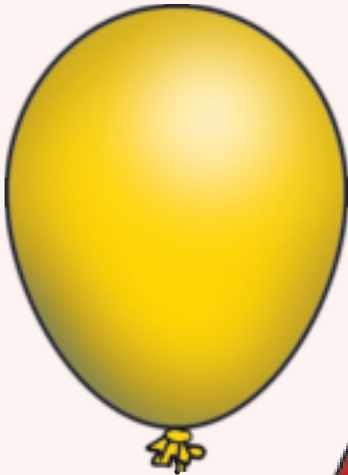

3.2



Bala ubiyele tintfo letimbili. Tsatsisa inombolo.

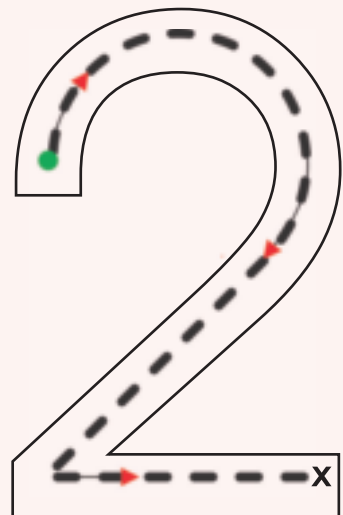
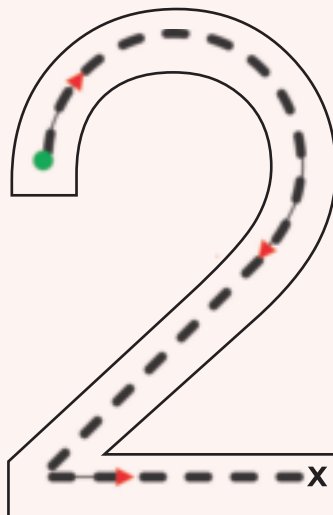
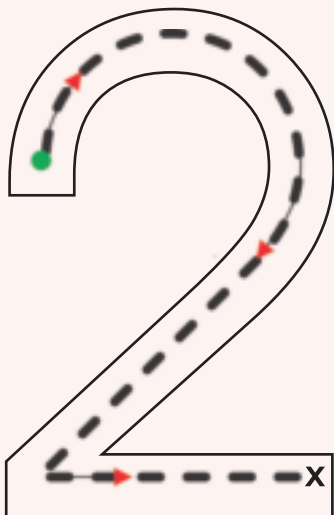



Penda kubili kulinye libhokisi.

Ithemu 1 – Liviki 1-5

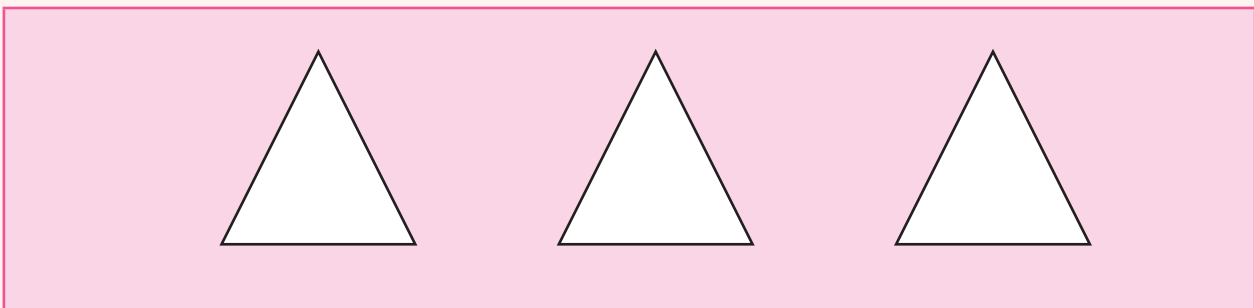
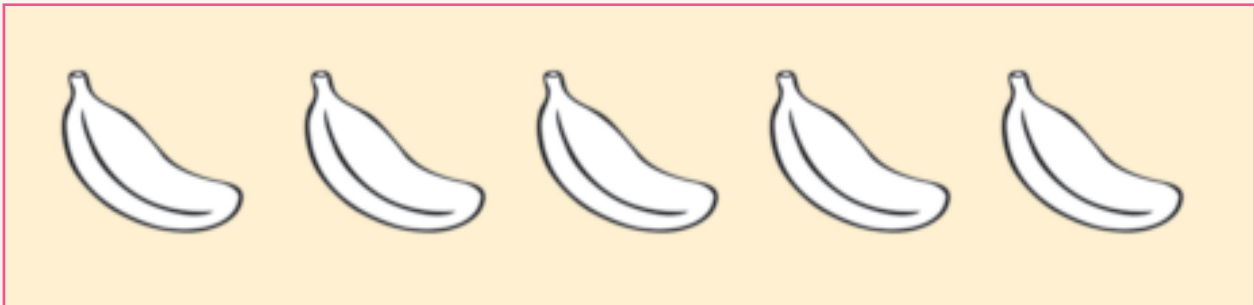
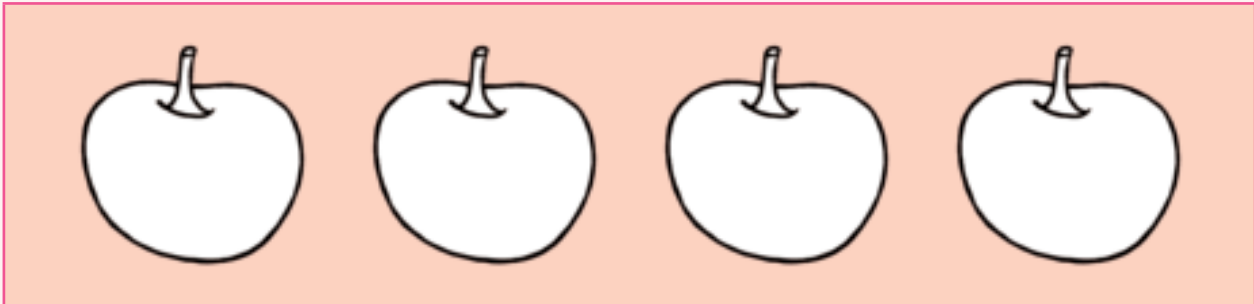



Asikhulume ngeluhlelo lwemalanga onkhe.



3.5



Nameka tinameko esikhwameni.

Ithemu 1 – Liviki 1–5





Landzela umkhondvo, unameke tinameko.

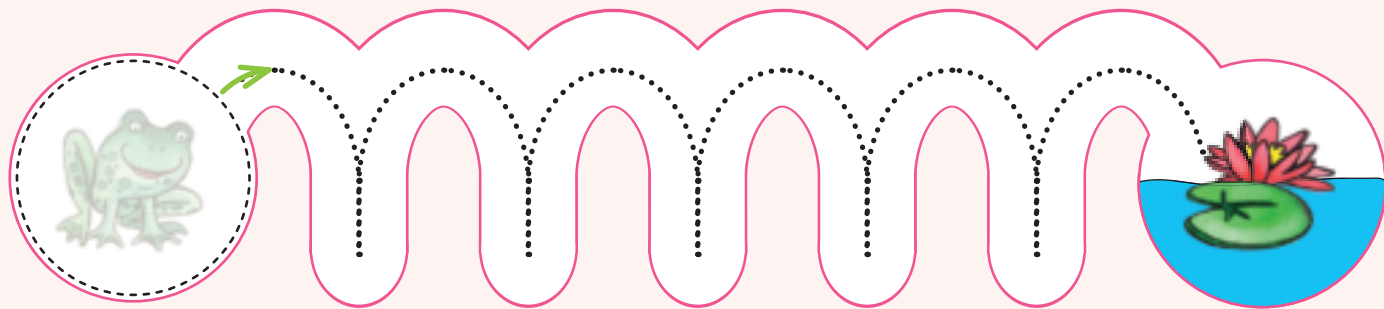
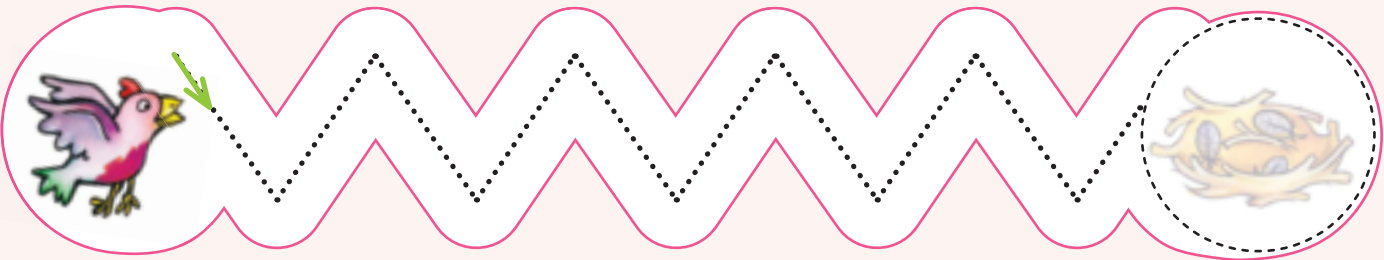
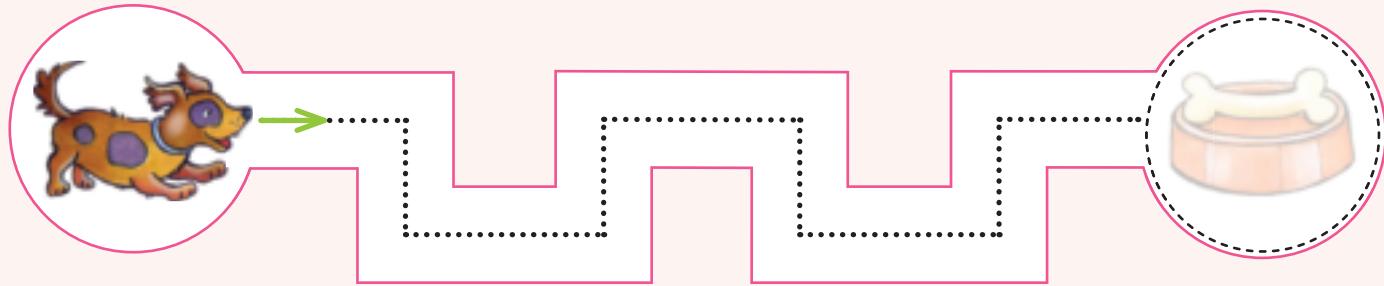
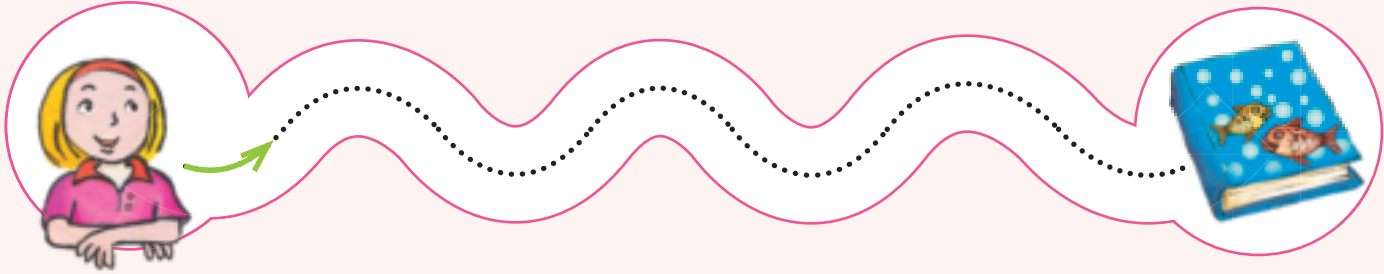



Asikhulume ngesitfombe.







Landzela umkhondvo ngemibala lefanele.

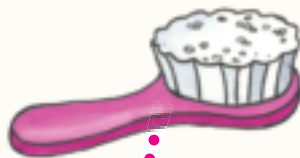

4.2



Tsatsisa ufake umbala wesicubho nemutsi wekugeza ematinyo.

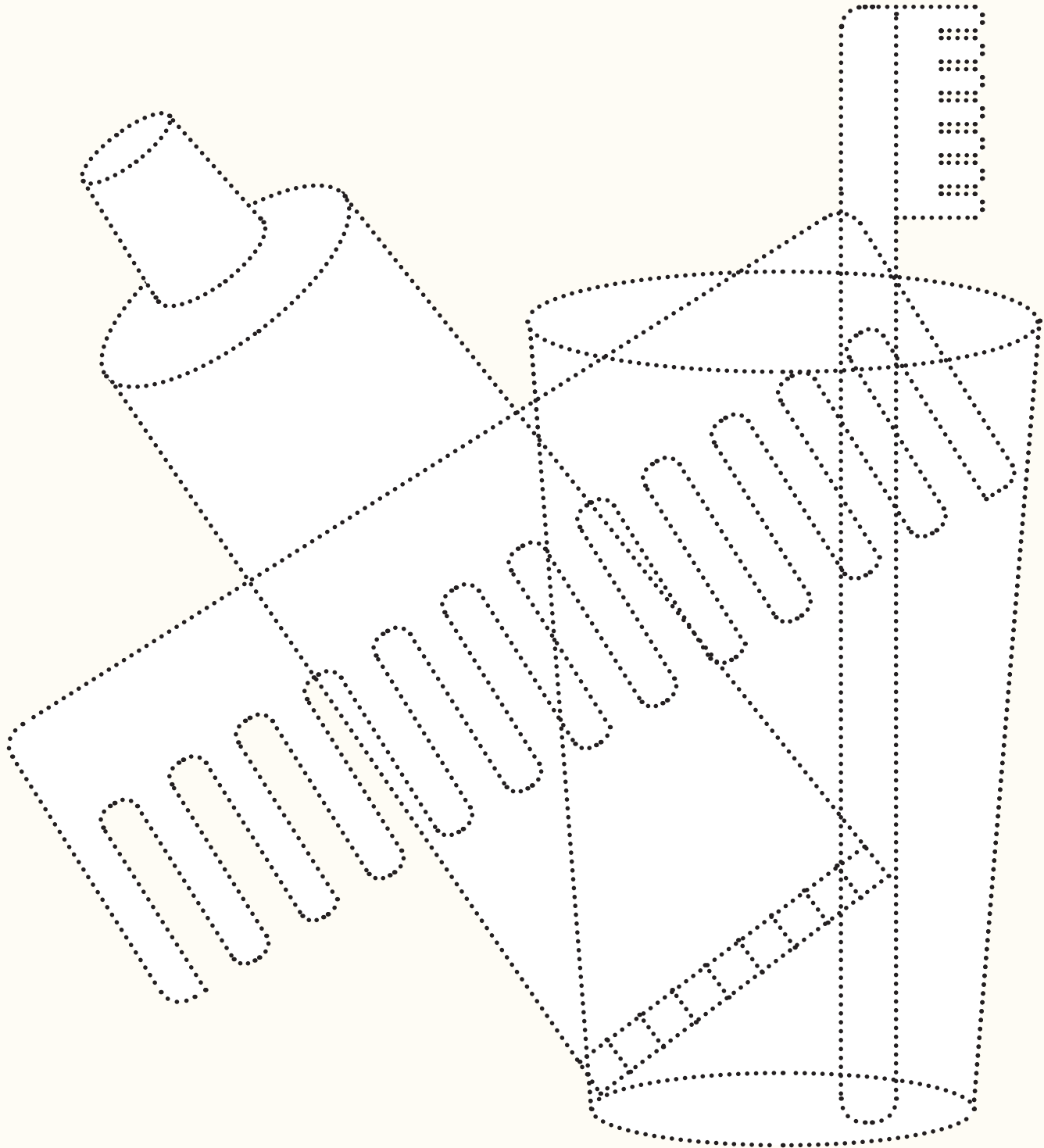



Biyela emabhokisi lanetintfo leti-3. Tsatsisa inombolo 3.

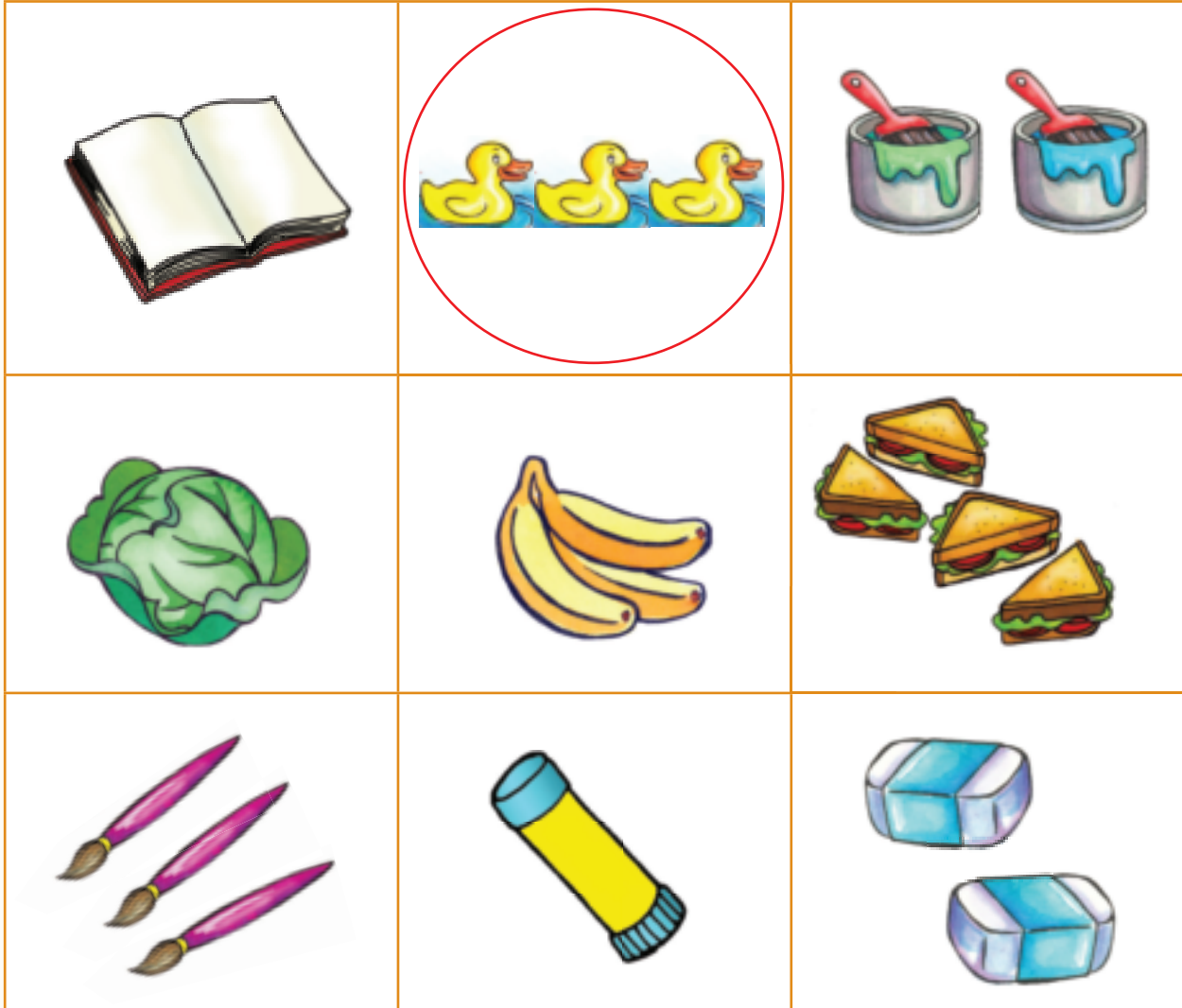

4.4



Sika letitfombe wakhe iphazili yakho.

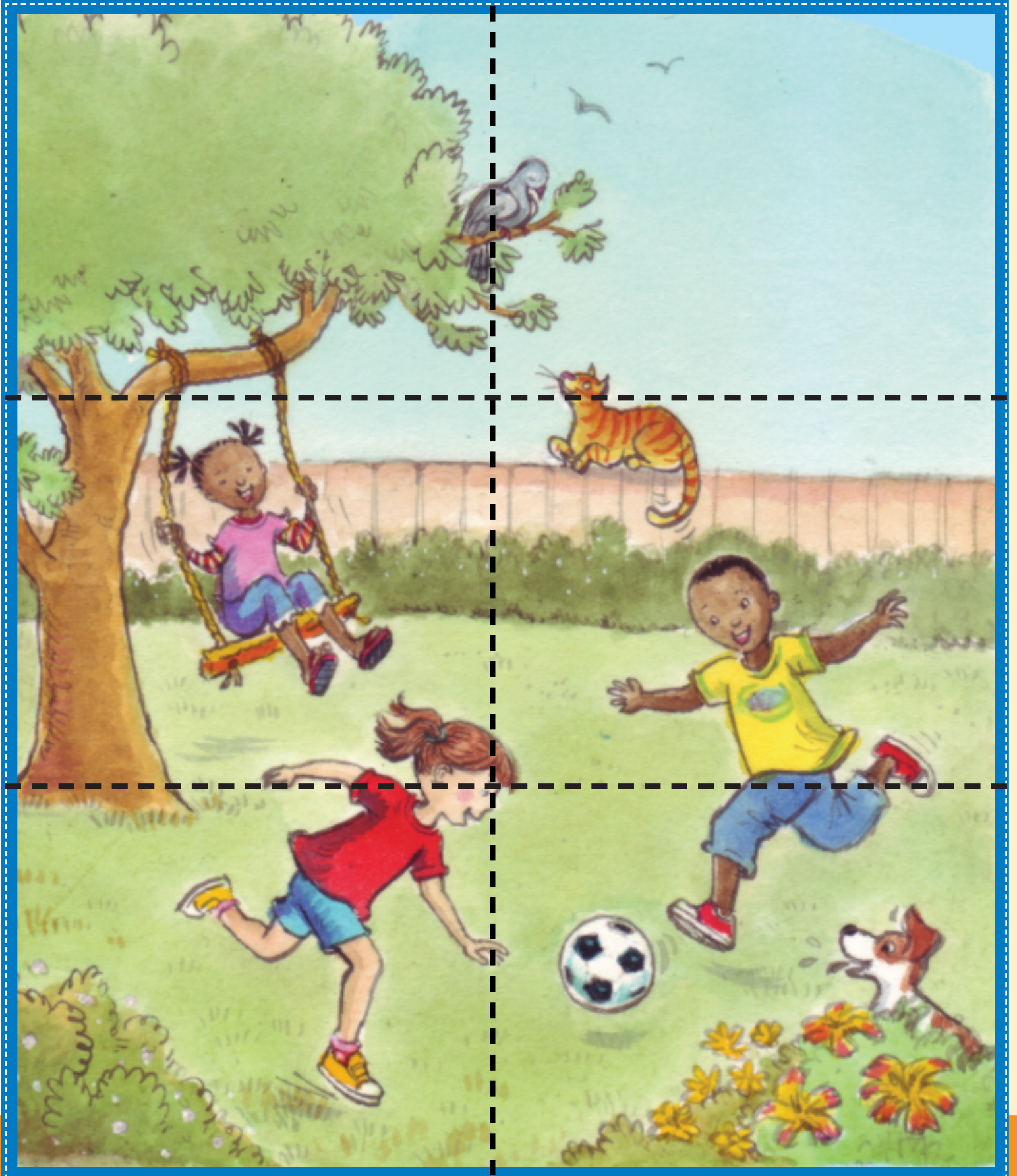

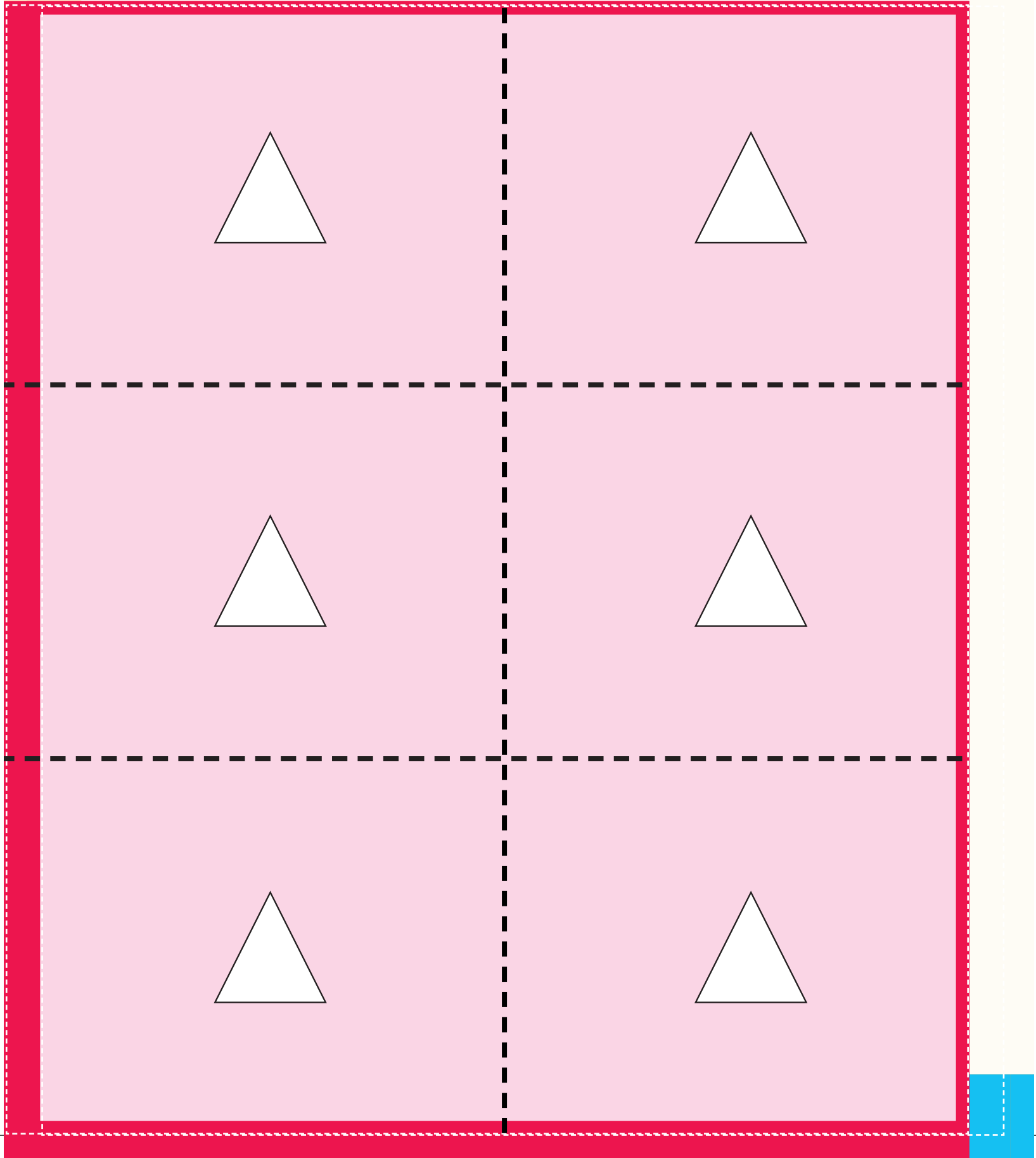
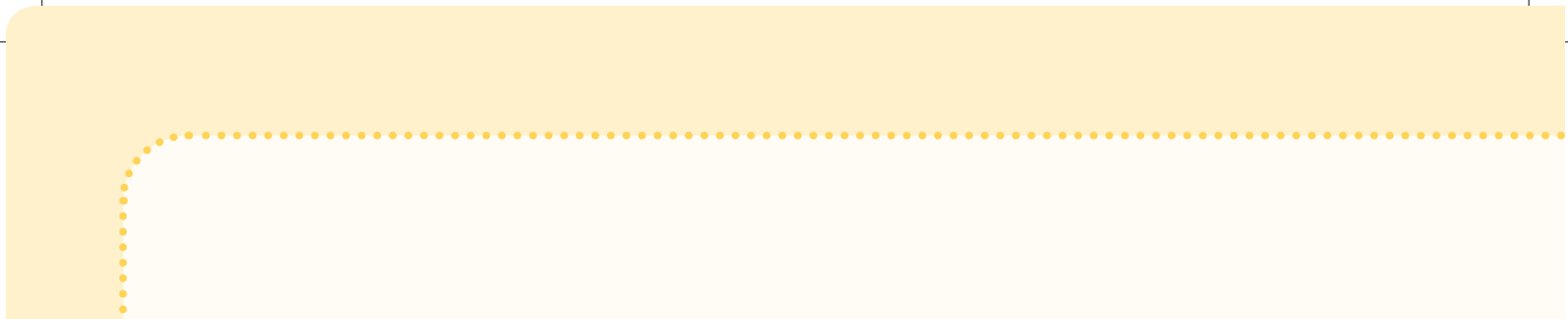



Sika letitfombe utihlele ngekulandzelana.



3

2

1

3

2

1

4.6



Nameka ubale ubuye utsatsise tinombolo.

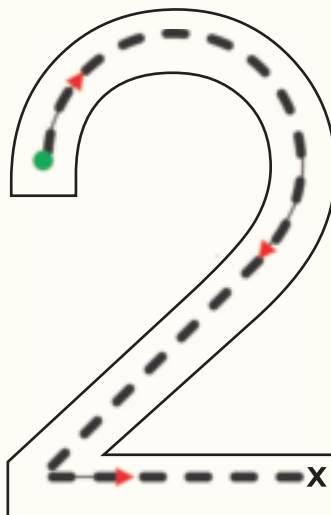

5

Bangani

Ithemu 1 – Liviki 6–10

Asikhulume.

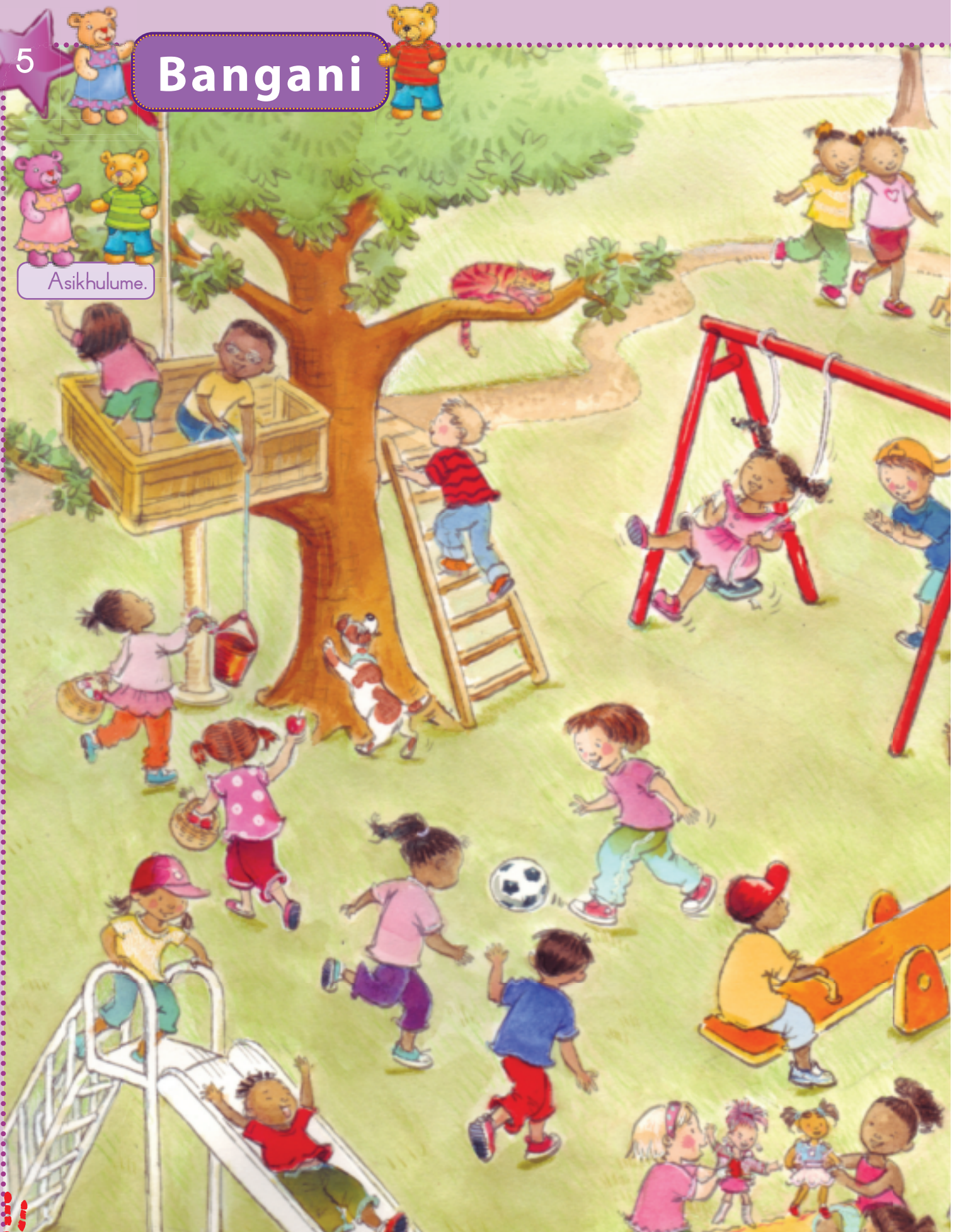





Biyela lokufana naloko lokusekucaleni.





Veta lokuhlukile.





Landzela umkhondvo ngemibala lef anele.

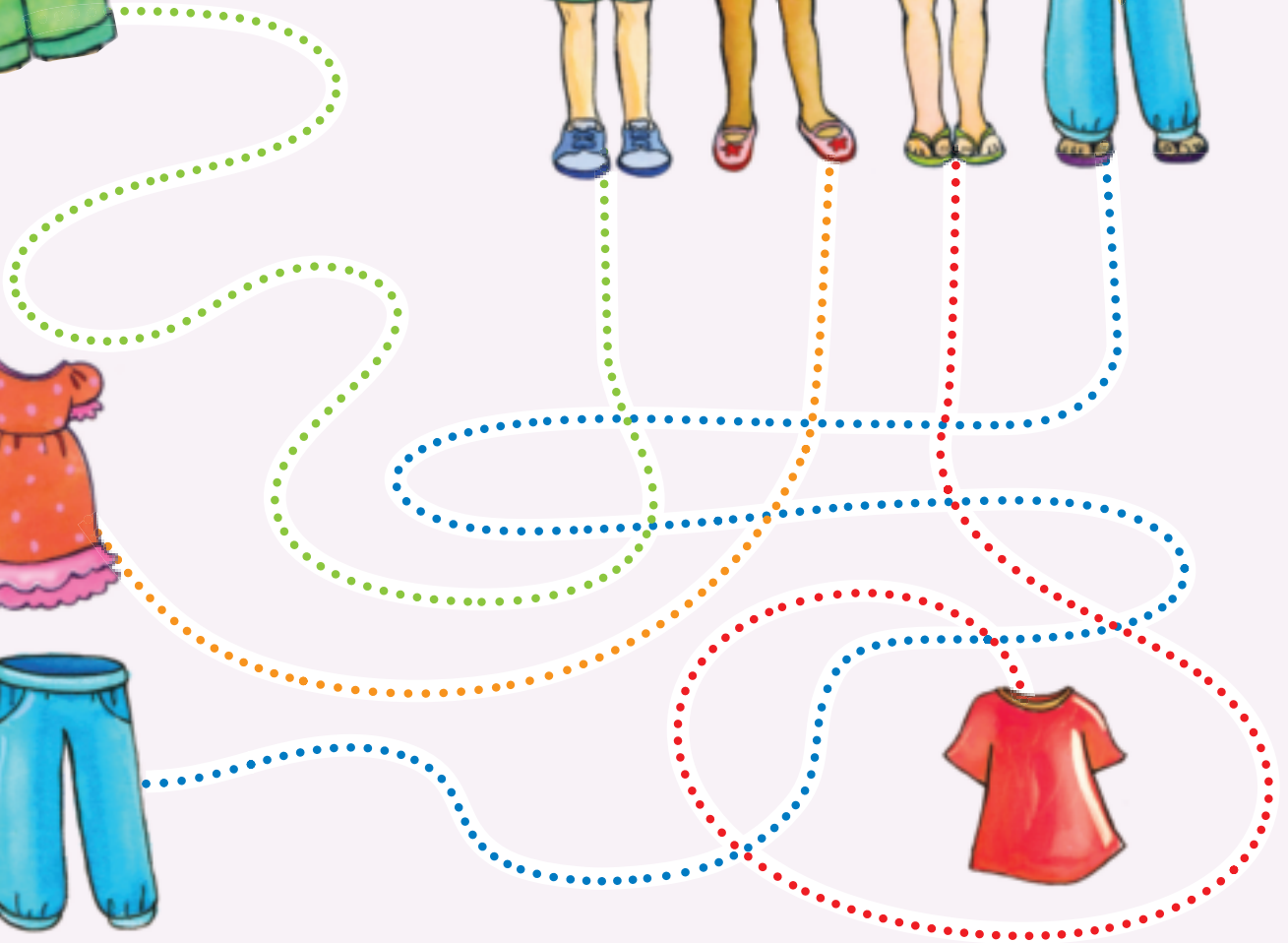
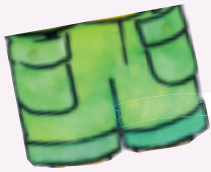



Nameka, ubale ubuye uf'ake umbala.

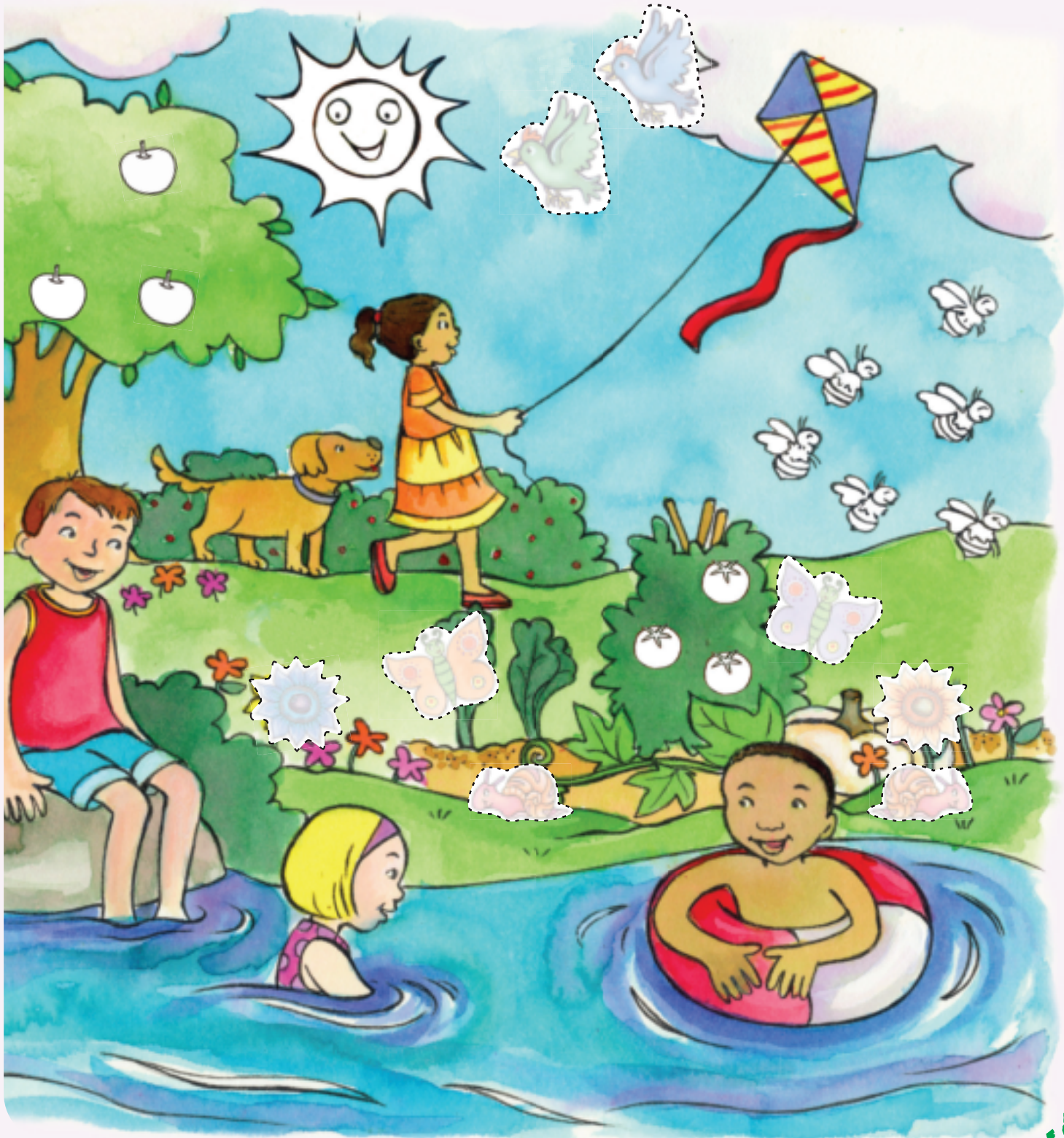



Biyela konkhe lokuhambisana nelihlobo.



5.6



Asikhulume sibuye sinameke.

kushisa

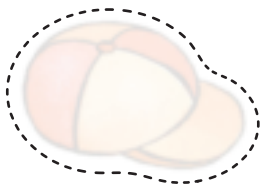
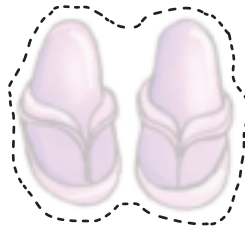
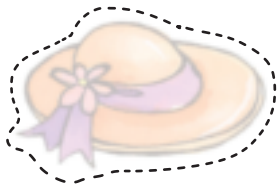



Asikhulume sibuye sinameke.



kubandza

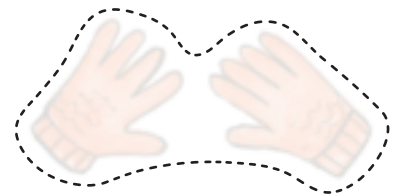



Sika tinkhomba utinameke kahle kusita bangani kuyofika kujanglijimu.

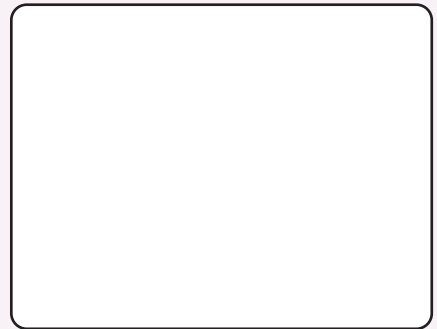
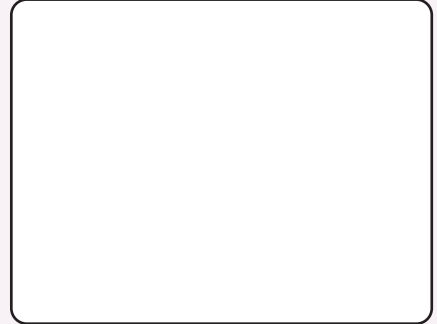
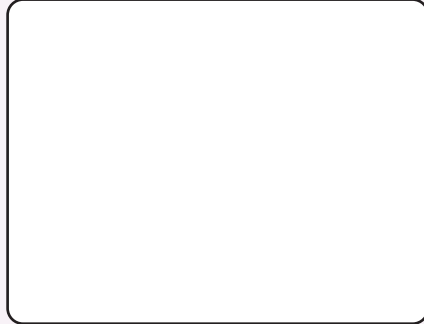



Lokusikiwe



Iphaphethi yeminwe:

Khetsa silwane si-1 ubhale luhlavu lwekucala lwegama lakho kuT-shethi yaso. Bhala tinhlavu leti-4 tekucala temagama ebangani bakho kuleletinye.



Timphica-nombolo:

Sika emigceni yemacashata kwakha emakhadi-nombolo lahambisanako. Chubeka ucondzanise titfombe netinombolo letifanele, noma nelinani lemacashata lelingilo. Ungasebentisa bobunjwa kukusita.

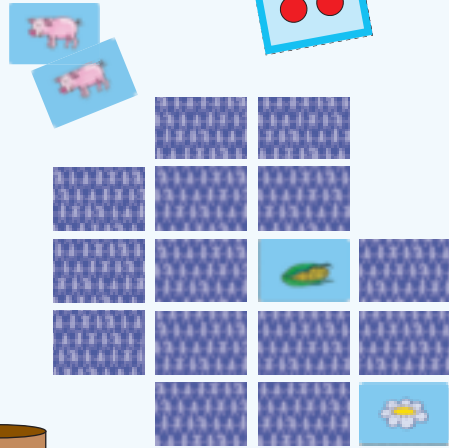

Khumbula phela:

Sika emakhadi emigceni yemacashata lamnyama. Washove uwahlanganise bese uwabeka kahle etafuleni abuke phansi. Nyalo gucula emakhadi mabili ngesikhatsi. Uma afanana ungawabeka eceleni. Bona kutsi ngubani locedza kucala kubeka emakhadi eceleni. Sebentisa emakhadi akho enkhumbulo udlale umdlalo wemakhadi nemngani wakho.

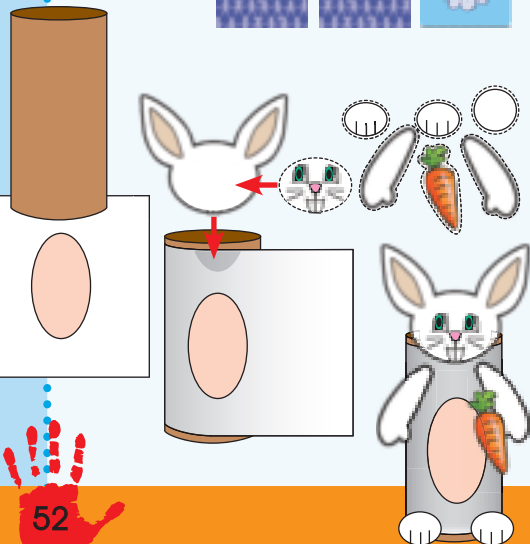

Tilwane teligwabugwabu:

Ase utfole umgogodla wethishu lese iphelile. Sika tintfo letibocalandze bese unamatsisela letincetu letinkhulu timbonye emashubhu aletigwabugwabu lethishu. Nyalo-ke sika tinhloko bese utinameka kuletigwabugwabu tethishu ngetulu. Sebentisa tinanyatsiselo tetilwane unamatsisele buso kuletinhloko ngendlela loyitsandzako. Nameka imikhono, imilente nemsila wesilwane kuletigwabugwabu. Uvumelekile kudweba wakhe takakho nje tilwane.

Yenta tincwadzi tabogili - gombo.
Sika emigceni legcamile ugobe
emigceni lengemacashata.



Tinombolo

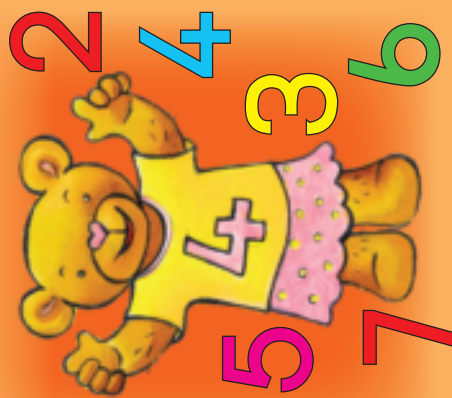

Tilwane
tekufuywa



1



kunye

2

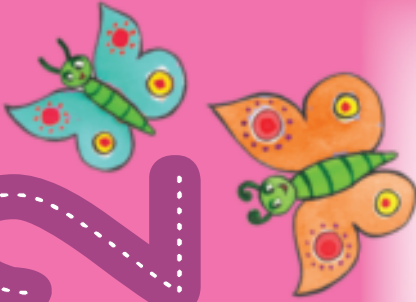

kubili

3



kutsatfu



inja



kati



inhlanti

umgololo



kune

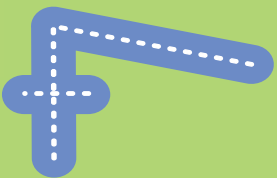
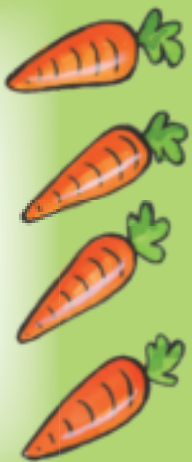

inyoni

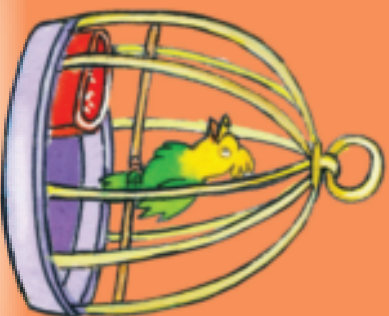

sihlanu



ligundwane
lekufuywa



sitfupha

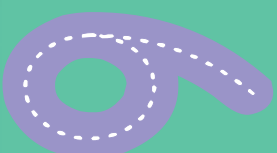

imbila



lisontfo

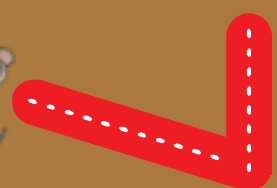



Asente loku

Sika likhasi emgceci wemacashata bese unamatsisela likhasi kukhava lengemuva kwakha sikhwanyana. Gcina lokusikiwe kwakho lapha kungeke kulahleke khona.

LOKUSIKIWE KWAMI

NAMATSISELA LAPHA

NAMATSISELA LAPHA

NAMATSISELA LAPHA

NAMATSISELA LAPHA

FOLD

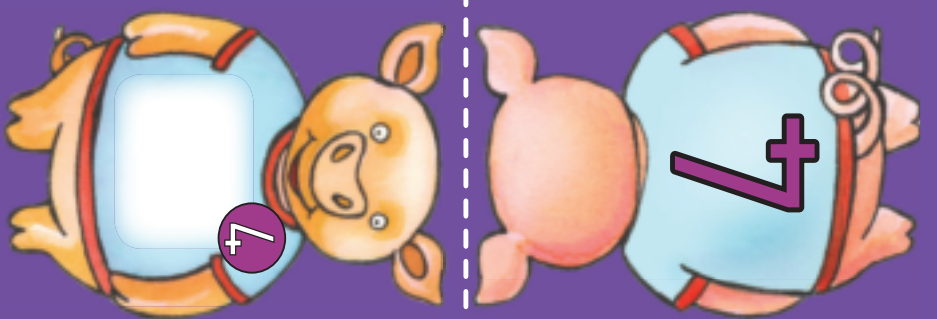

- 0
- 1
- 2
- 3
- 4
- 5
- 6
- 7
- 8
- 9
- 10
- 11
- 12
- 13
- 14
- 15
- 16
- 17
- 18
- 19
- 20
- 21
- 22
- 23
- 24
- 25
- 26
- 27
- 28
- 29

a b c d e f g h i j k l m n o p q r s t u v w x y z



0 a
1 b
2 c
3 d
4 e
5 f
6 g
7 h
8 i
9 j
10 k
11 l
12 m
13 n
14 o
15 p
16 q
17 r
18 s
19 t
20 u
21 v
22 w
23 x
24 y
25 z

GLUE HERE

GLUE HERE

GLUE HERE

GLUE HERE

GLUE HERE

GLUE HERE

GLUE HERE

GLUE HERE

GLUE HERE

GLUE HERE



1



2

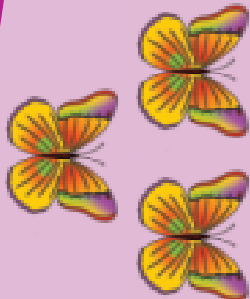
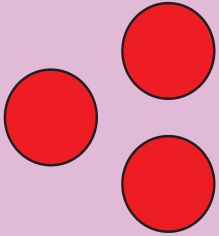

3

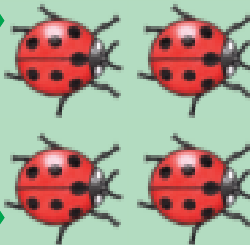
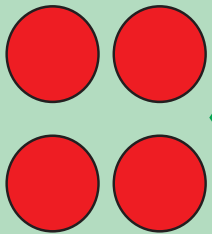

4

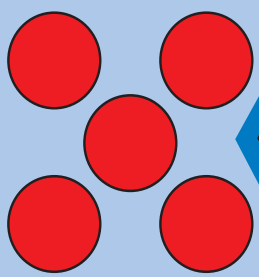

5







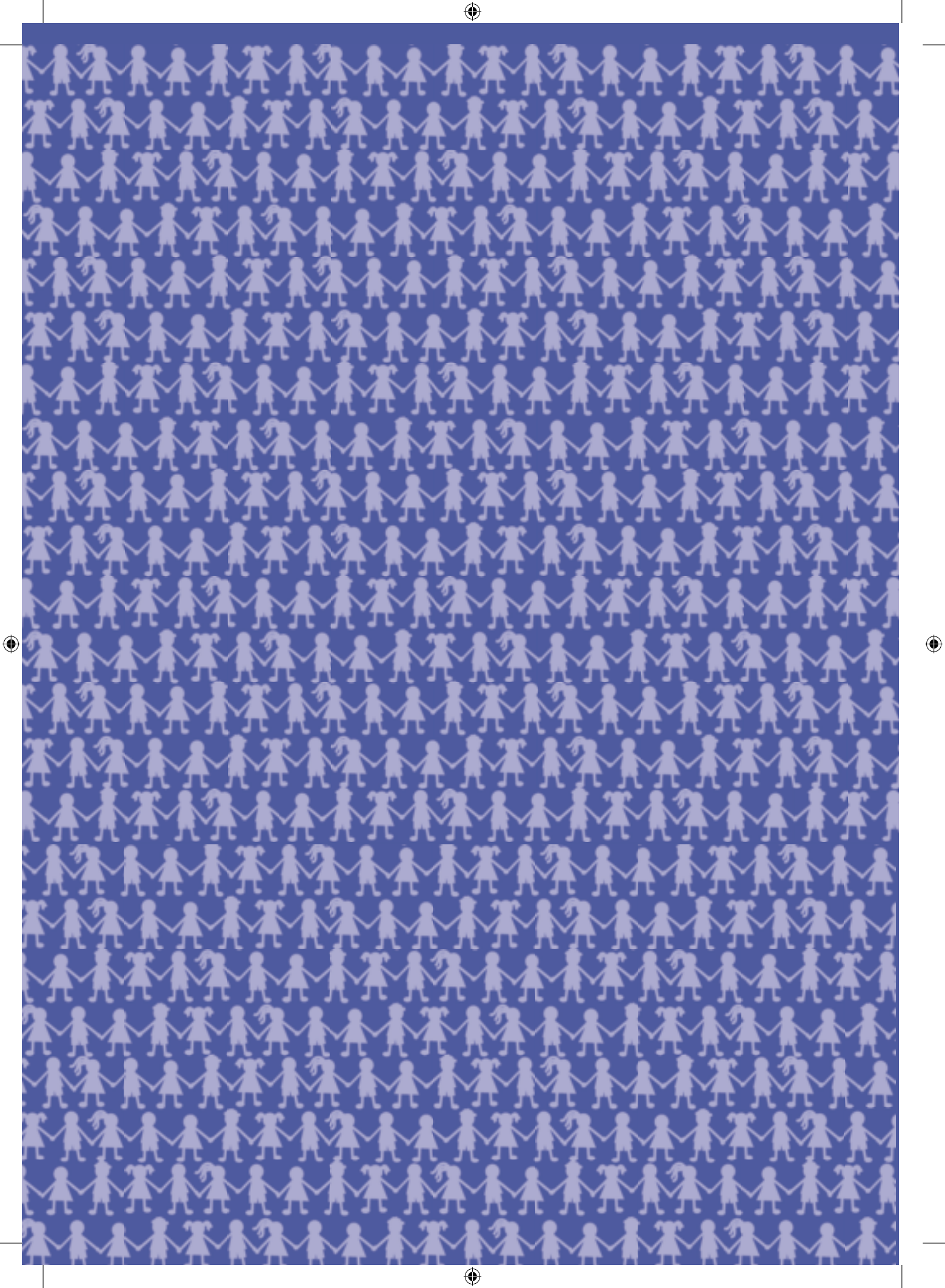

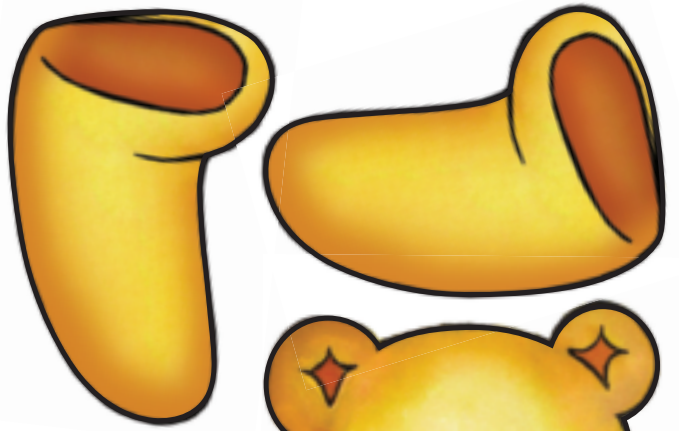
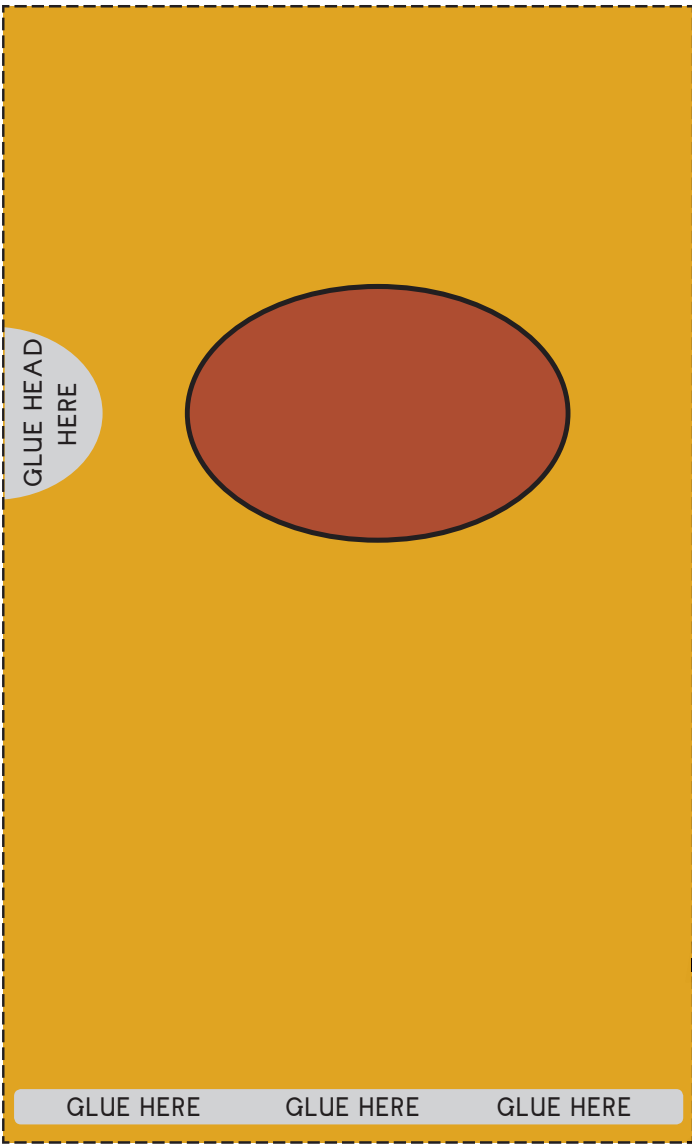

TEDDY BEAR

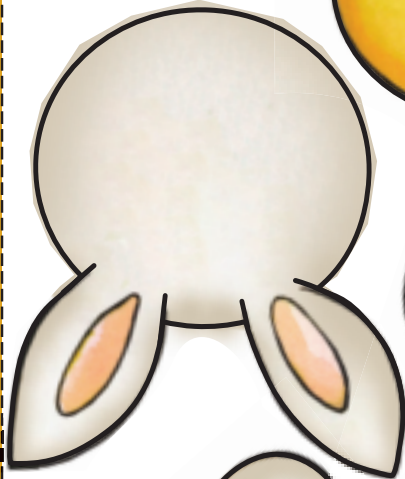

RABBIT

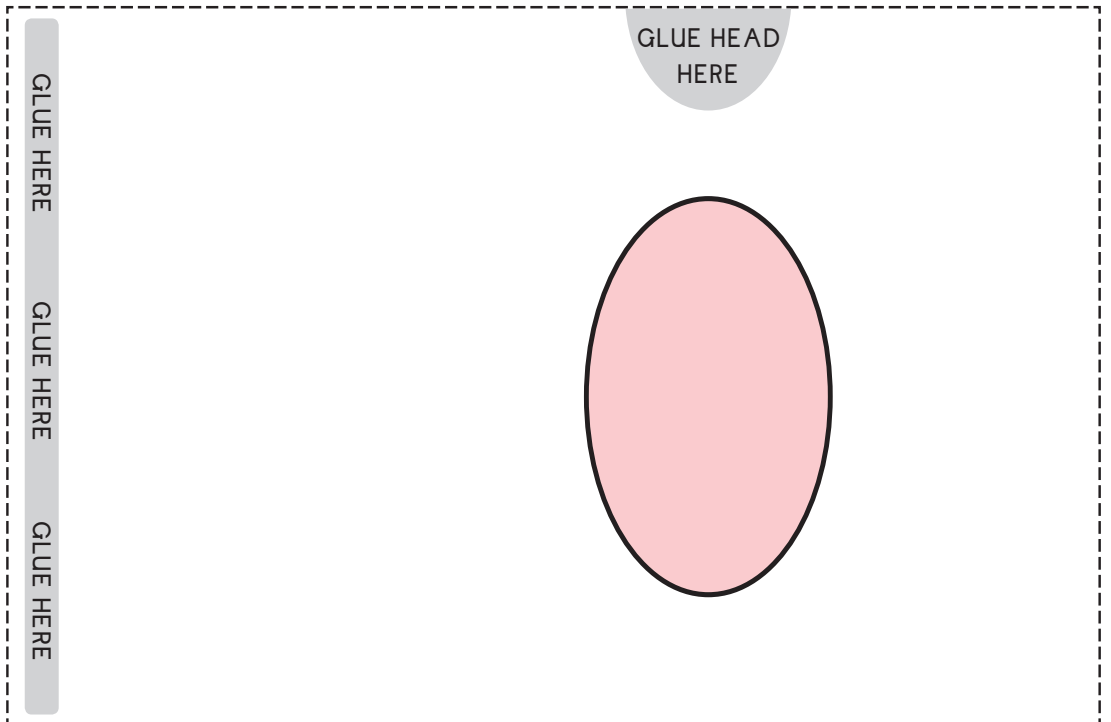

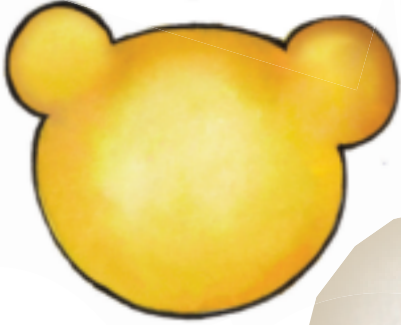
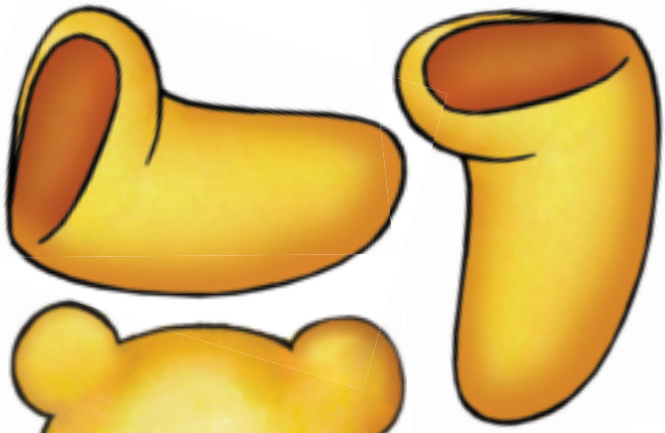

STICKERS

GRADE R BOOK1

8



6



12



20



30

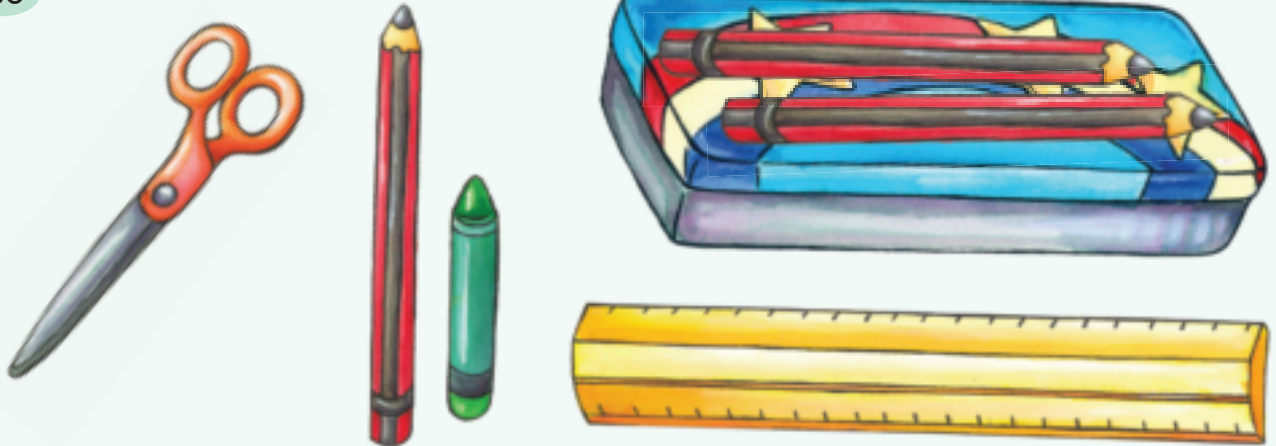

31



43



47



49-50



TEDDY BEAR

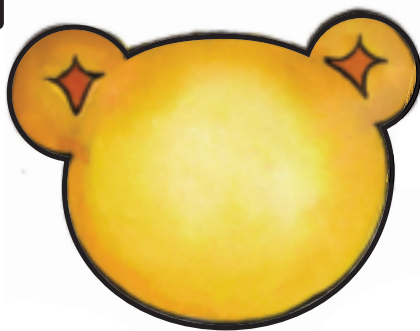

ARMS

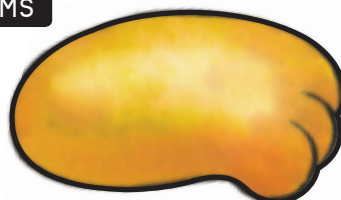
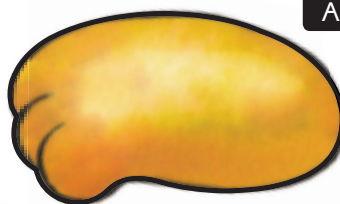

NOSES & MOUTHS

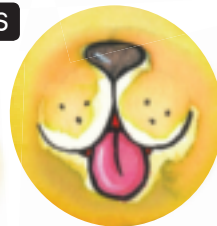

TAILS

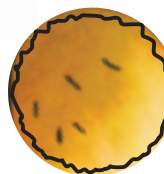
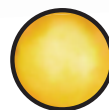
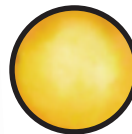

EYES

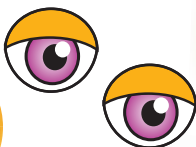

FACES



ARMS

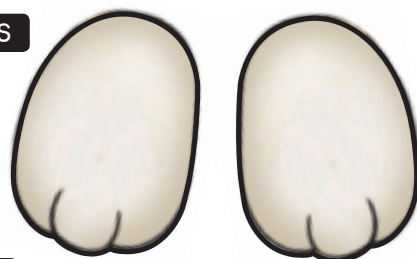
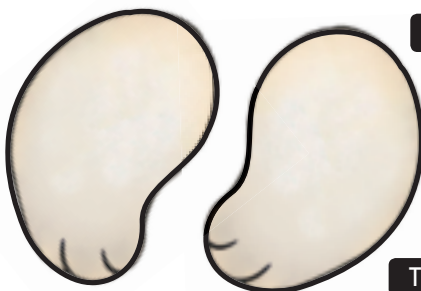

TAILS



EYES



FACES

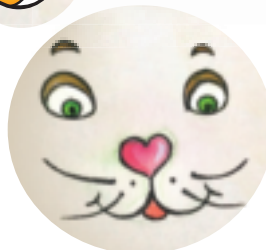

RABBIT

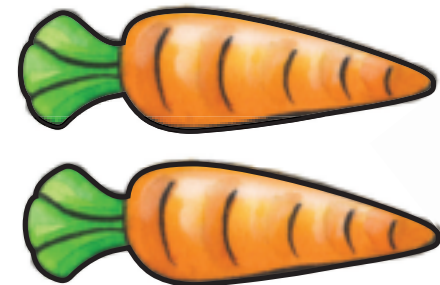

12

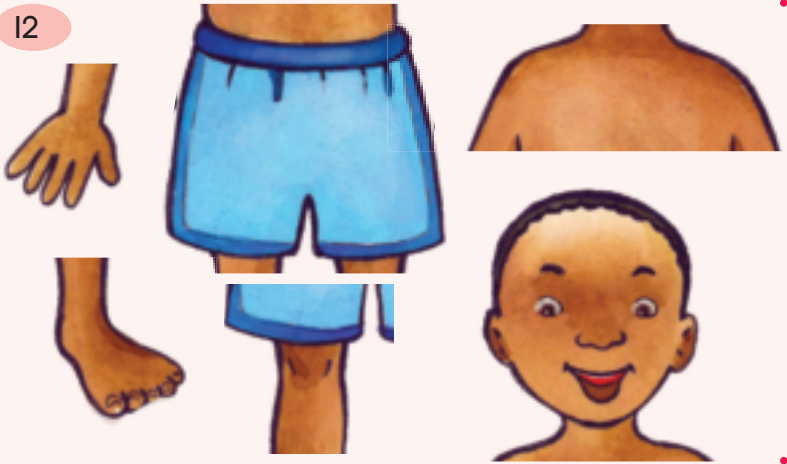

33



30



41

