



TSHIVENĀ
GRADE R – BOOK 1
TERM 1
 ISBN 978-1-4315-0698-9
 THIS BOOK MAY NOT BE SOLD.
14th Edition



Gireidi ya **R**



Yo
 vusuludzwa,
 i tevhedza
CAPS

Dzina:



basic education
 Department:
 Basic Education
 REPUBLIC OF SOUTH AFRICA



TSHIVENĀ

Bugu ya



Themo ya!



Vho Angie Mutshekga
Minista wa Muhasho
wa Pfunzo ya Muteo



Vho Dr Reginah Mhaule,
Muthusaminista wa
Pfunzo ya Muteo.

Bugu idzi dza Rainbow Workbooks dza n'waha wa Zwixele (Grade R) ndi tshipiḁa tsha tshitiirathedzhi tsha Muhasho wa Pfunzo ya Muteo tsha u khwiḁisa kushumele kwa vhana vha tshikolo vha Afrika Tshipembe pfunzoni dzavho. Thodisiso (risetshe) i sumbedza uri arali vhana vha nga nyanyulwa siani la pfunzo n'waha muḁwe na muḁwe musi vha sa athu u thoma Gireidi 1, hu swika hune vha shuma zwavhuḁi pfunzoni dzavho dza miḁwaha i no ḁo tevhela - pfunzoni ya phuraimari na ya sekondari. Ndi ngazwo ho sedzeswa kufunzele kha Gireidi R.

KharikhuJamu ya Vhuimo ha Fhasi i na thodea yauri vhagudi vha Gireidi R vha tea u fhiwa tshikhala tsha u alusa zwikili zwa thangelauvhala, thangelauḁwala na thangelambalo, ya dovha hafhu ya bula zwikili zwine vhagudi avha vha tea u vha nazwo zwa u wana murango wo khwaḁhaho wa pfunzo u itela uri u guda hu vha lelutshela musi vha tshi swika kha Gireidi 1 na u fhirela phanḁa.

Zwenezwoha, ndivho ya bugu dza u shumela dza Gireidi R ndi ya u thusa vhana uri vha aluse zwikili izwi zwe zwa bulwa khathihi na u alusa kuhumbulele kuhulwane kune vha tea u ku ḁalukanya musi vha tshi ḁisimela murango wo khwaḁhaho wa pfunzo. Buguni idzi hu na zwikhala zwe vhana vha n'waha uri vha bvedze na u ḁiḁowedza zwikili zwine zwa ḁo vha pfundisela tshikolo tsha fomaJa.

Musi vhana vha sa athu u guda u vhalo vha tea u ranga nga u ḁalukanya kufarelwe kwa bugu, u fhenda masiatari na u ḁalukanya uri bugu i shuma nga nḁilade. Vha tea u ḁalukanya vhusaka vhukati ha maipfi na zwifanyiso zwi re buguni khathihi na u ḁalukanya uri matsina maipfi a re kha siatari o vhubwina nga mibvumo nahone a na zwine a amba. Zwo ḁi ralovho na kha u n'waha. Vhana vha tea u alusa u ḁhaḁulana ha zwipfi zwavho (motor coordination), vha ita nḁowenḁowe dza kusikelwe kwa zwivhumbeo, vhee vho no ralo, vha ita nḁowenḁowe dza kusikelwe kwa maJedere. Ndi zwikili zwenezwi zwine idzi bugu dza u shumela dza lila u alusa kha vhana.

Ri a zwi ḁivha uri vhana a vha gudi mazha (khathihi) lune bugu dza u shumela dza Gireidi R dza vha na vhuḁanzi tshoḁhe uri vhadededzi (vhagudisi) vha shume vha tshi tevhela kugudele kwa n'wana mugele e eḁhe nahone, hune zwa konadzea, vha shumise bugu idzi vha tshi ya phanḁa na u humela murahu, zwi tshi edza nyaluwopfunzoni ya n'wana uyu i re yawe e eḁhe.

Nyito (mishumo) dzi re buguni dzi ḁo thusa vhadededzi kha u topola zwikhukhulusi zwine vhana vha nga vha nazwo pfunzoni hu u itela uri zwi bviswe nḁilani ya n'wana musi a sa athu thoma pfunzo ya fomaJa.

Bugu dza u shumela idzi dzi vanganya u funzwa luambo (ngudaluambo), mbalo na zwikili zwa vhutshilo kha thero dza 20, hu tshi shumiswa nḁila dzi no mvumvusa na u kunga vhagudi vhane vha kha ḁi vha vhaḁuku. Ri na fulufhelo lauri vhagudi vha ḁo ḁiphiḁa musi vha tshi khou ita nyito dzi re buguni idzi zwenezwi vha tshi khou aluwa na u guda, nauri na vhonevho sa mudededzi wavho, vho ḁo ḁiphiḁa navho.

Tshumisano



U fhaḁa phazili...



basic education
Department:
Basic Education
REPUBLIC OF SOUTH AFRICA



SCAN HERE
or visit OMO.CO.ZA
for fun activities in
the OMO Messy
Play Zone.



Gireidi ya **R**

HO VANGANYWA

- Luambo
- Mbalo
- Zwikili zwa Vhutshilo

1	Nga ha nne	2
2	Muvhili wanga	12
3	Kilasi yanga	24
4	Kutshilele ku re na mutakalo	32
5	Khonani	42

TSHIVENDĀ

Bugu ya



Themo ya 1

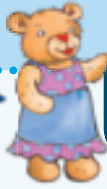

Nga ha n̄e



Themo ya 1 – Vhege dza 1-5



Tevhedzelani ni khalare.

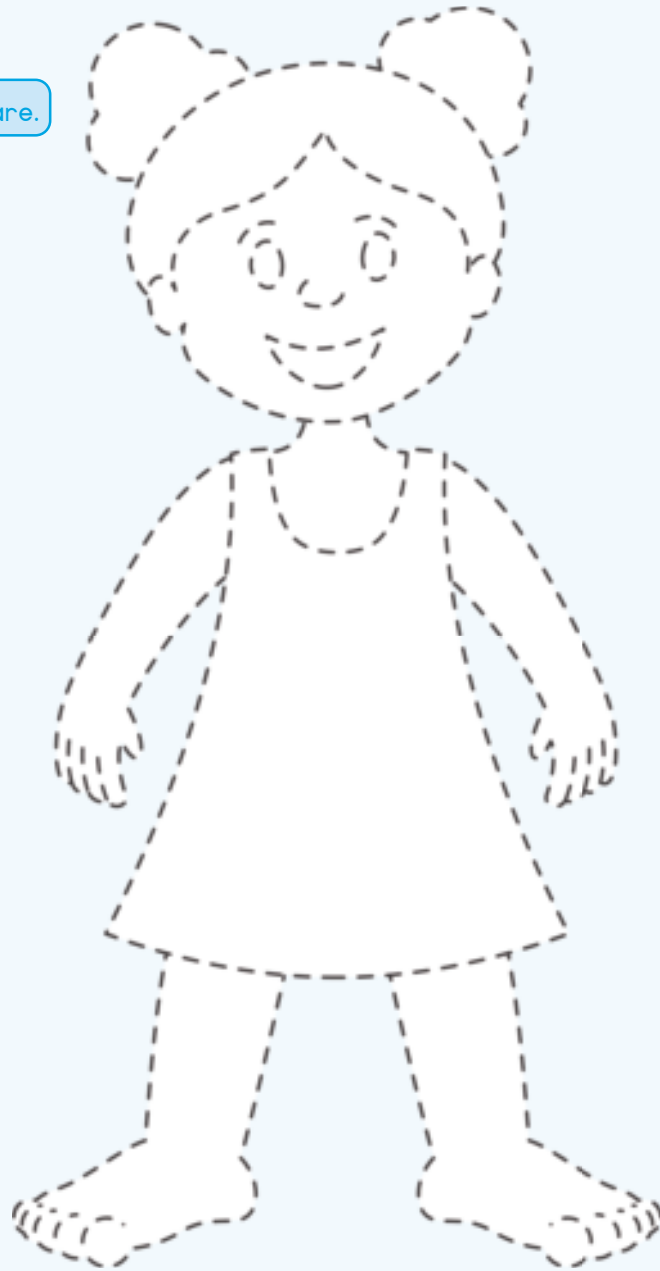

N̄e ndi

musidzana



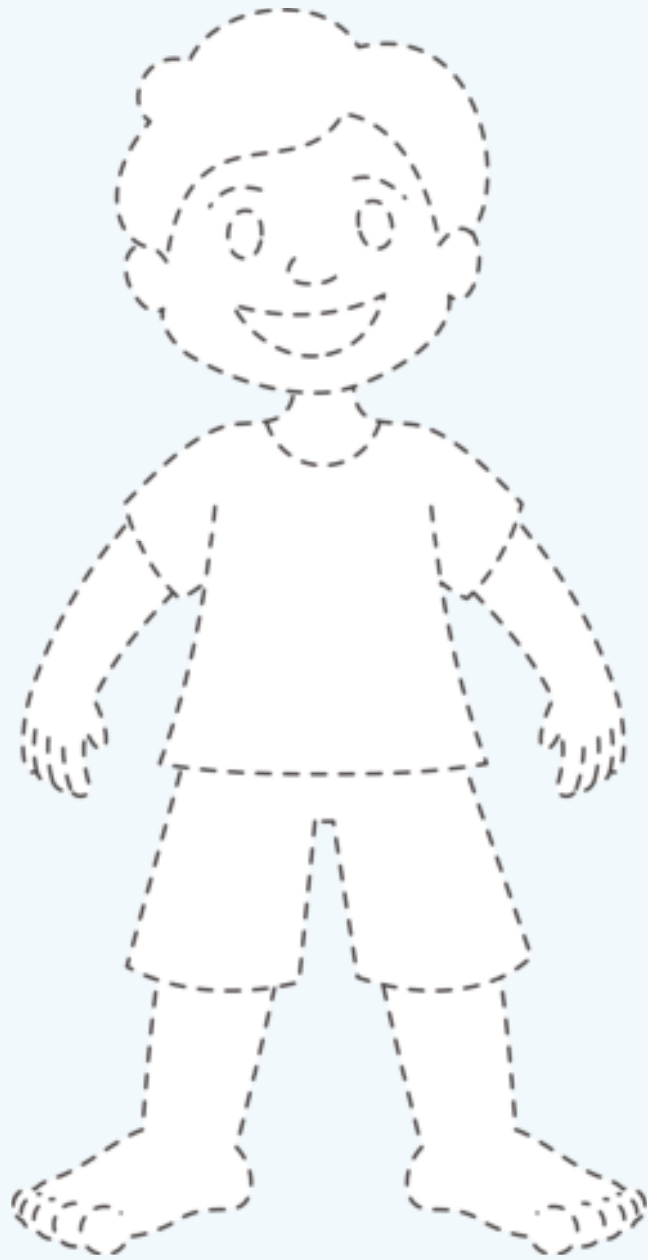

N_{ne} ndi

mutukana



Olani tshifanyiso tshanu.

1.2



Tingeladzani khekhe ya minwaha yaṅu, ni khalare makhandela ayo.

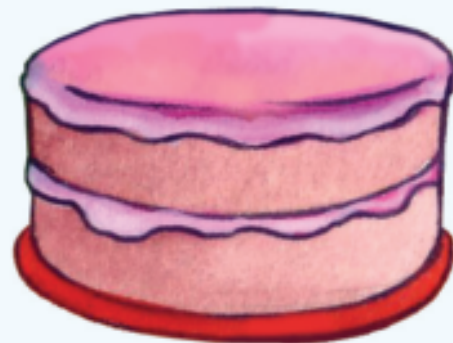

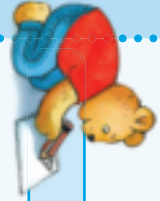
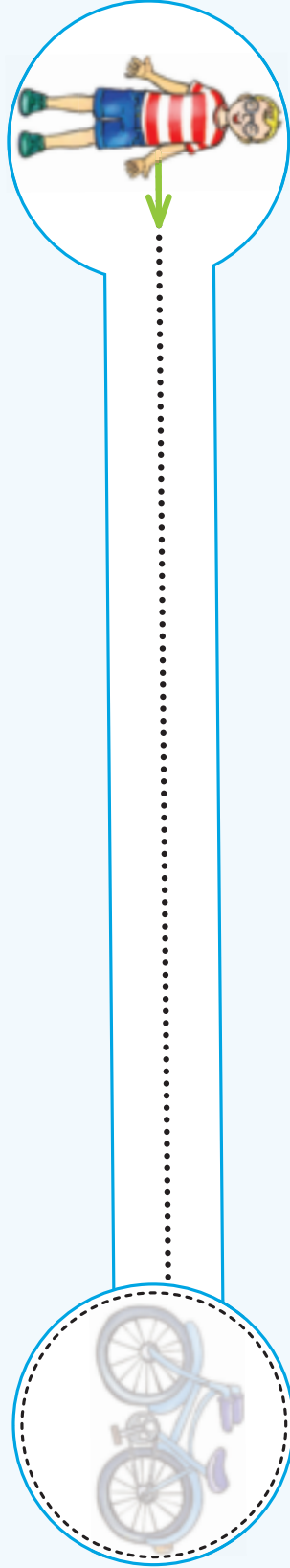
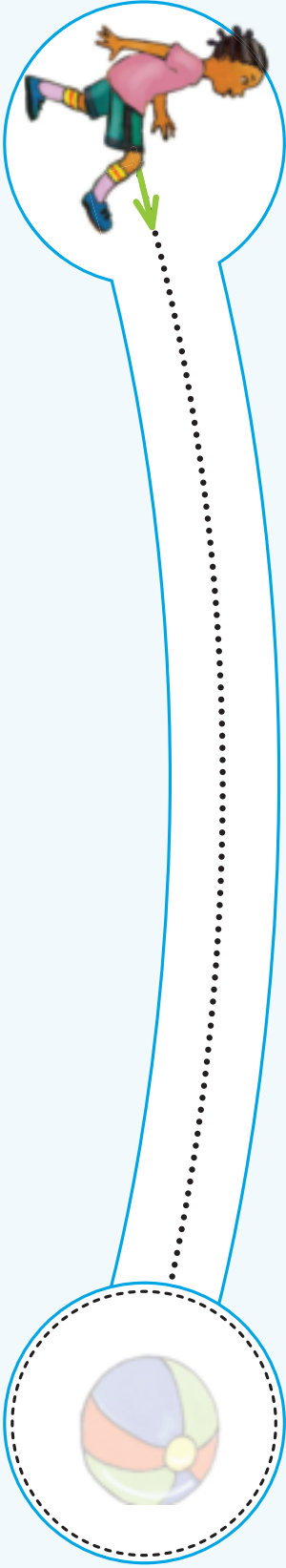

Nambatedzani zwiṭikara ni tevhedzele mitalo.



Shumisani thikhi ni nange muvhala wa maṭo aṅu Shumisani thikhi ni nange muvhala wa mavhudzi aṅu.

Muvhala wa maṭo anga

Muvhala wa mavhudzi anga

15



Olani tshifhatuwo tshanu.

Themo ya 1 – Vhege dza 1-5





Ambani nga ha zwine na zwi takalela ni thikhe tshibogisi tsha hone.

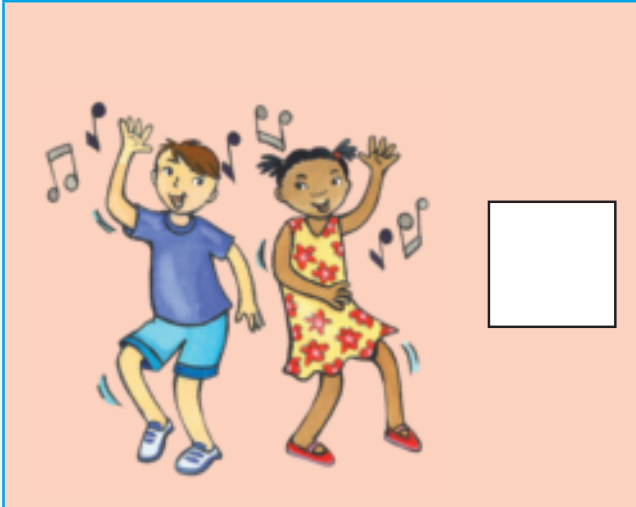









Livhanyani zwif anyiso.



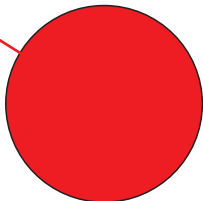



















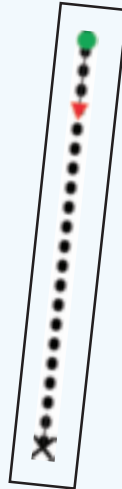
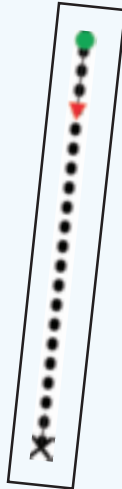
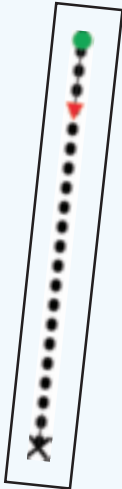

Tingeledzani zwibogisi zwine zwa vha na tshithu tshithihi ni tevhedzele nomboro 1.



2



Muvhili wanga



Haseledzani ni nambatedze zwipiḡa zwo ṭahelaho.



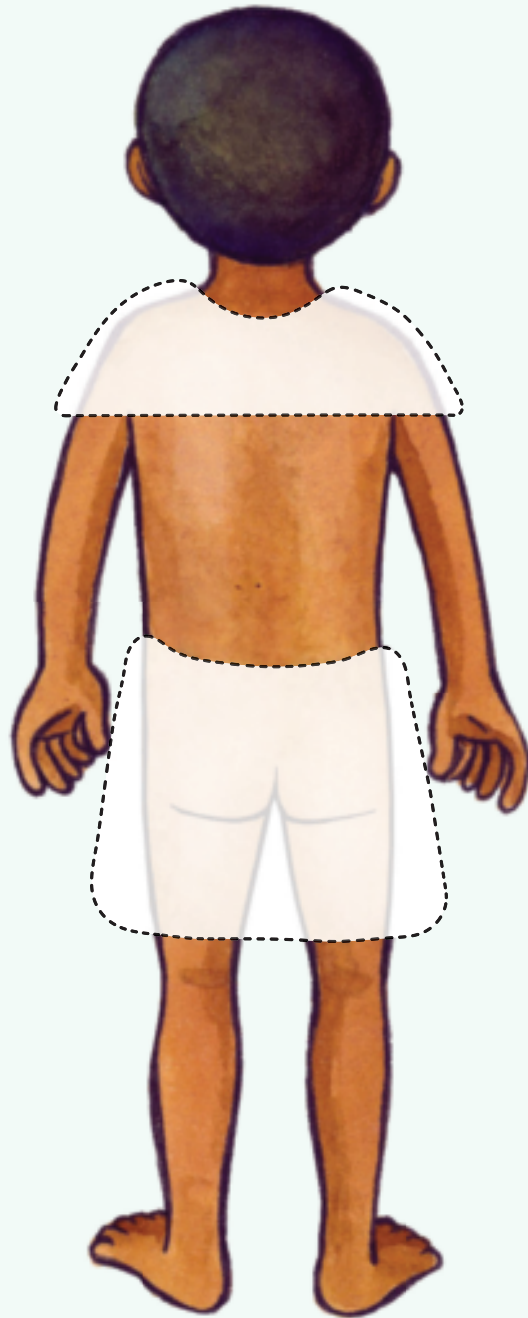

21



Tevhedzelani ni khalare zwi fane na kha tsumbo.

Themo ya 1 – Vhege dza 1-5

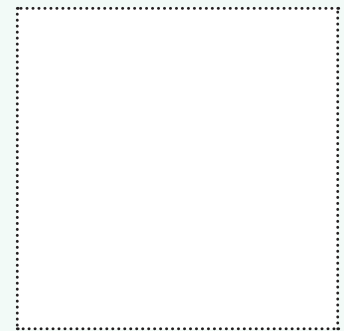
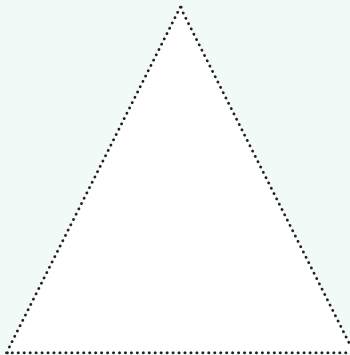
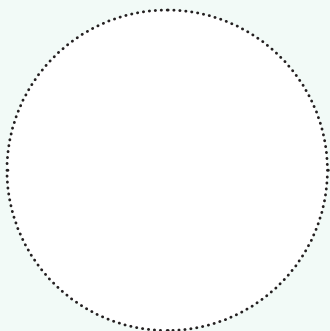
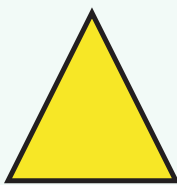
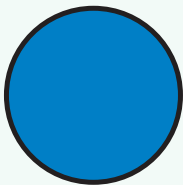
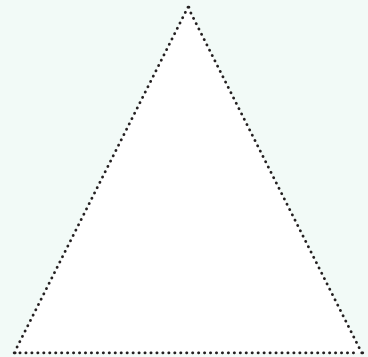
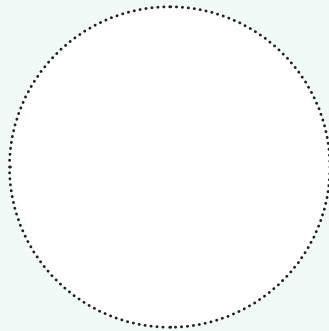
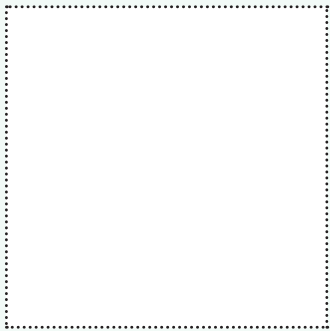
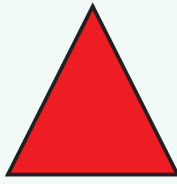
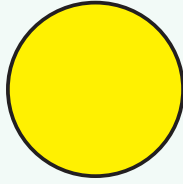
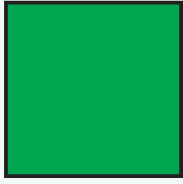

2.2



Petani kha mutalo wa zwithomathoma.

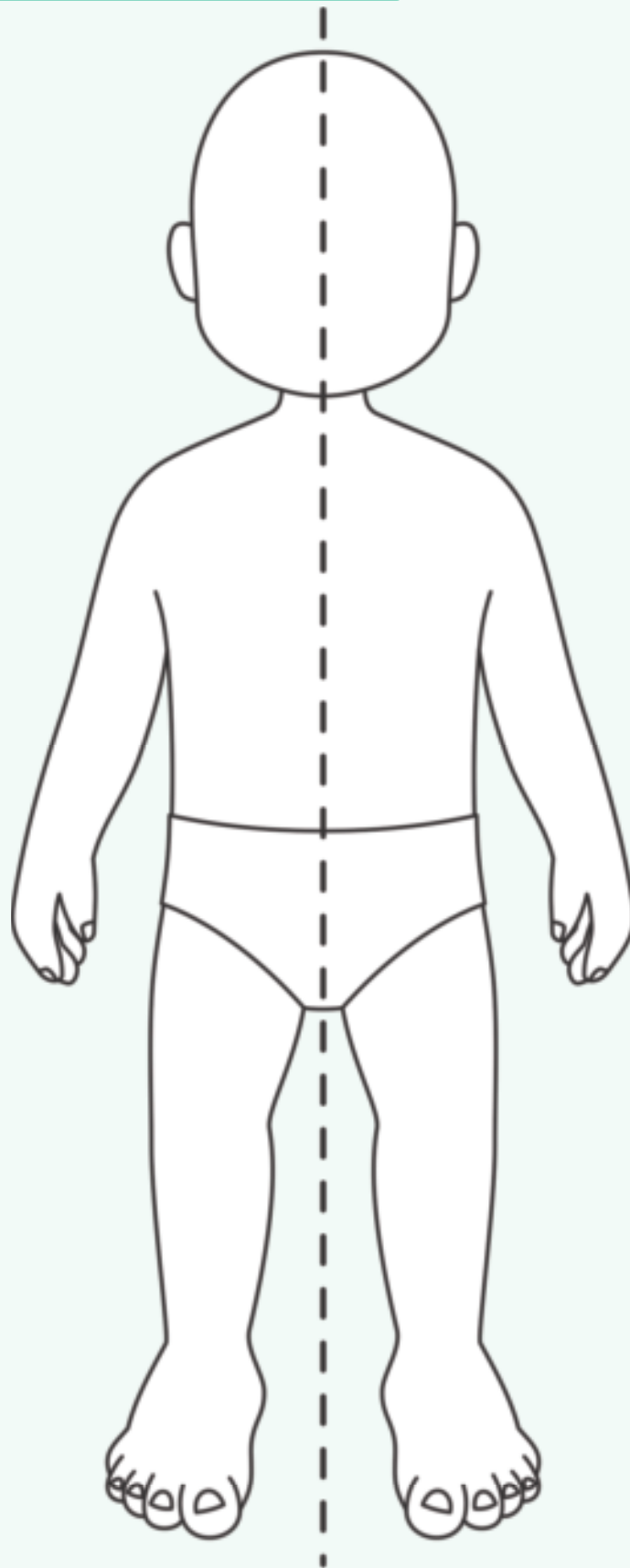

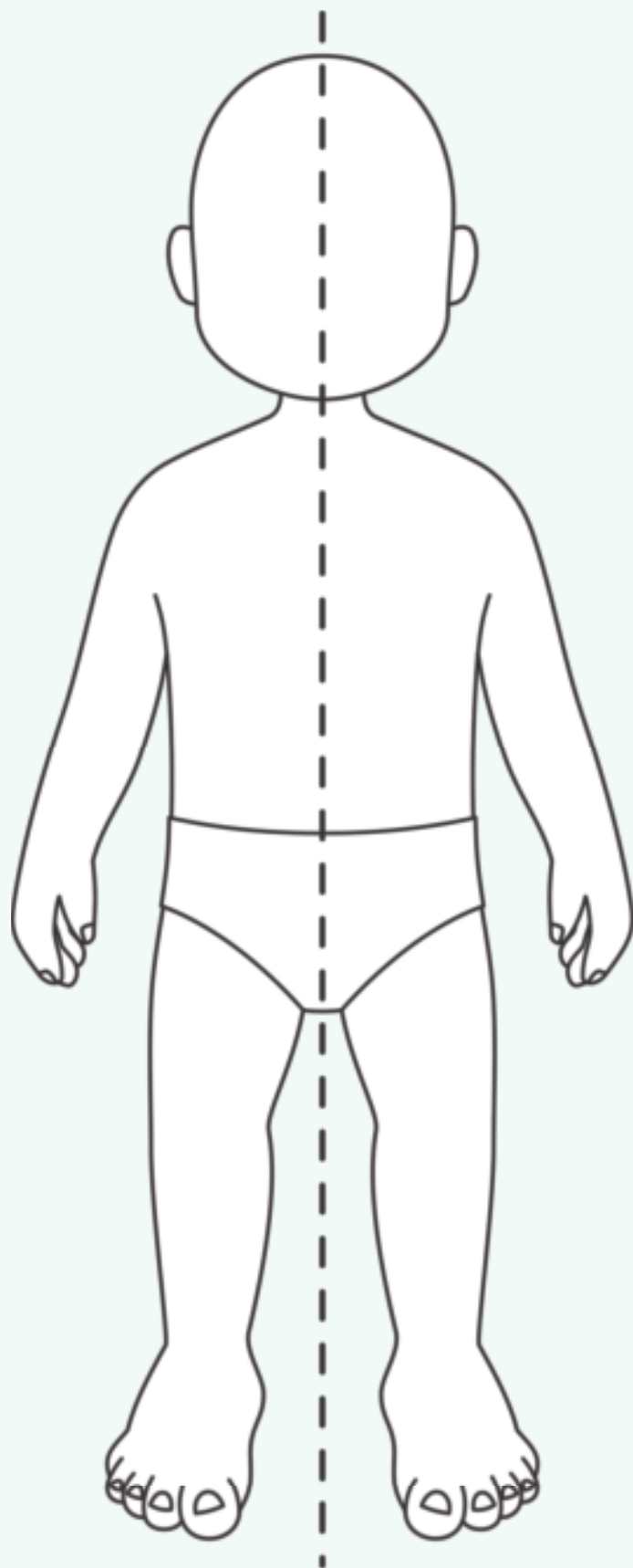

2.3



Gerani ni nambatedze nga ndila yo teaho.

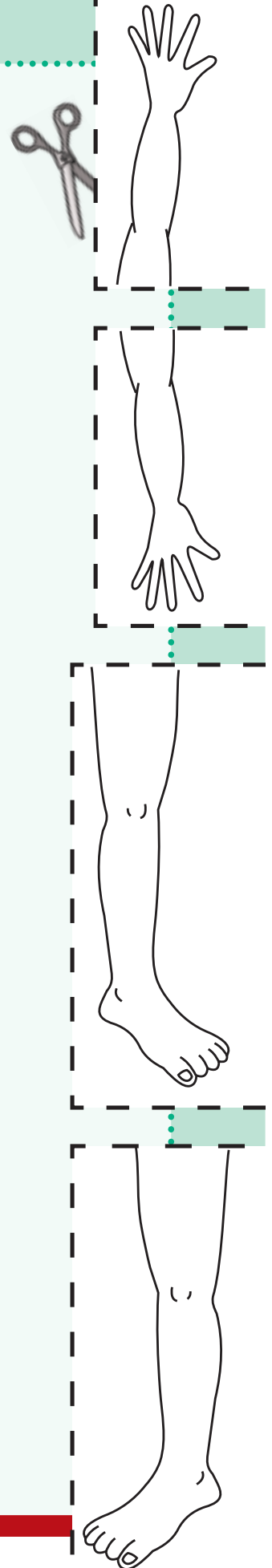
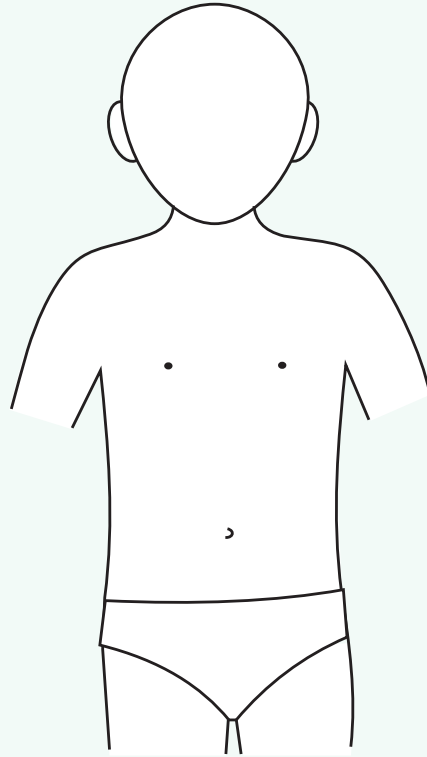

MUGUDISI: Tsaino

Datumu

2.4



Tevhedzelani kha tsha monde kana kha tshauḽa.



Gandisani minwe yaḽu kha zwibogisi.





Ambani nga ha mutevhe wa nyito dzi itwaho nga matsheloni.

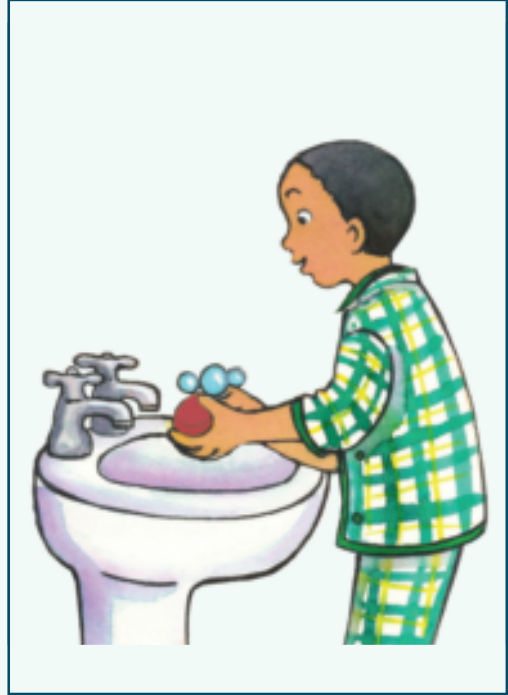



Tingeledzani tshifanyiso tshi songo teaho.

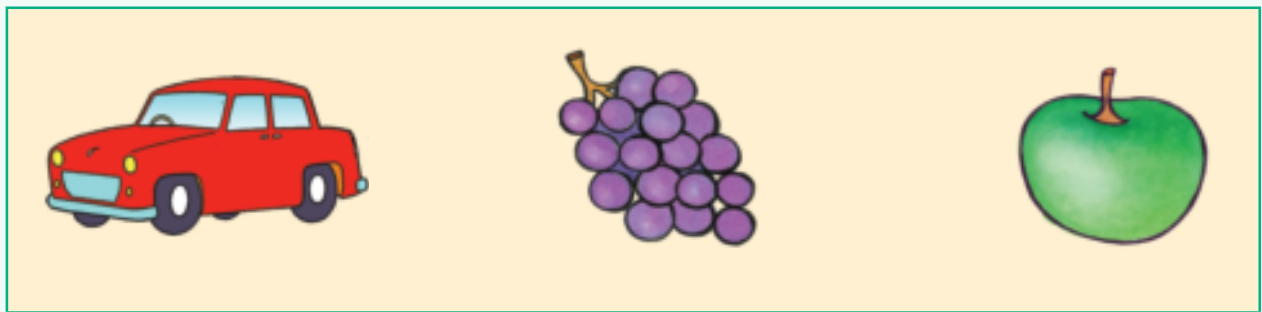
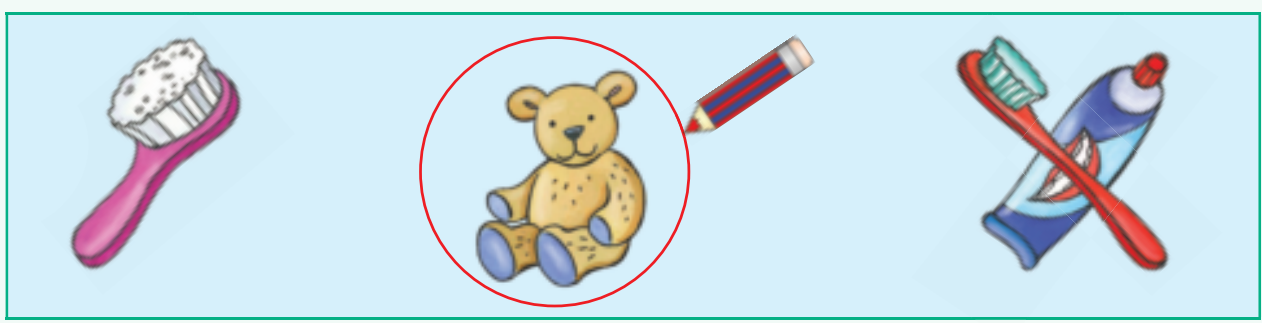



Tingeledzani tshifhatuwo tshine tsha fana na tsha u thoma kha muduba

Themo ya 1 – Vhege dza 1-5

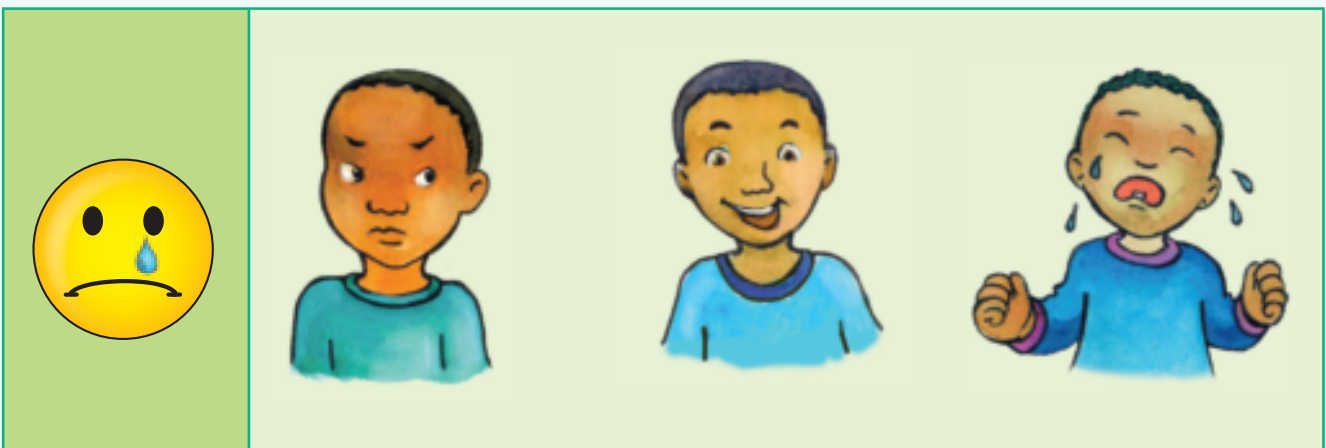
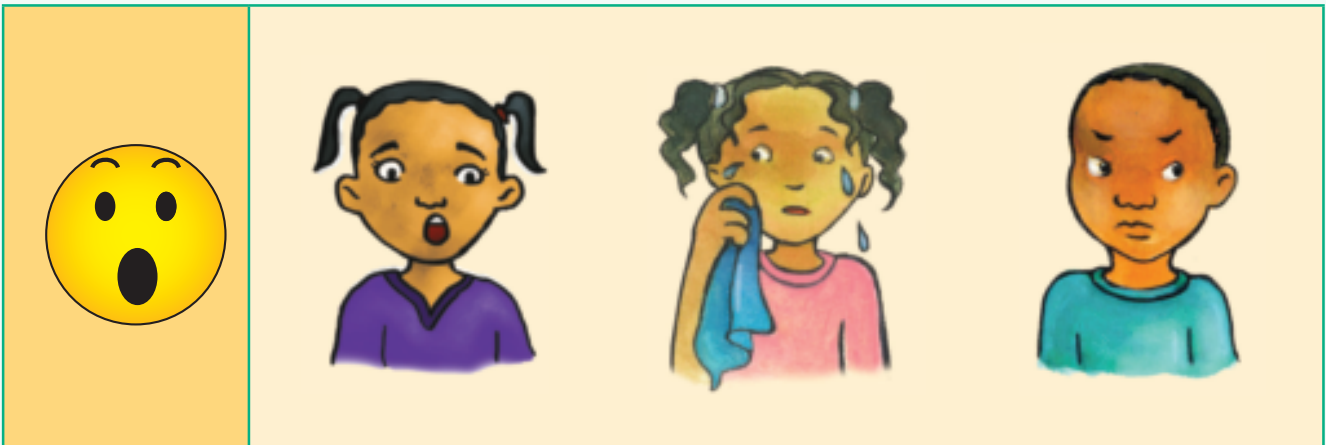



Kopololani phetheni ni khalare.

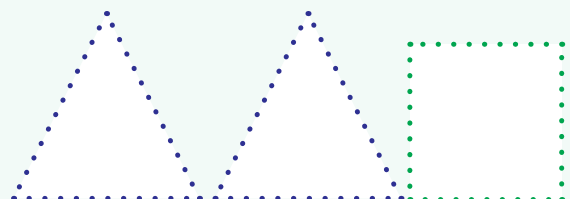
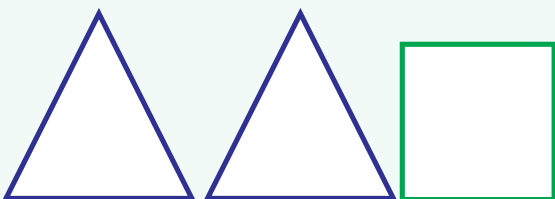
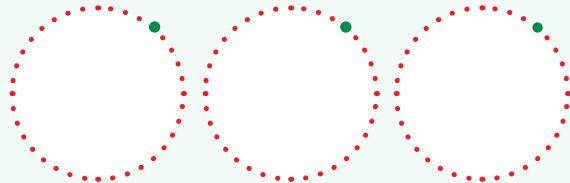
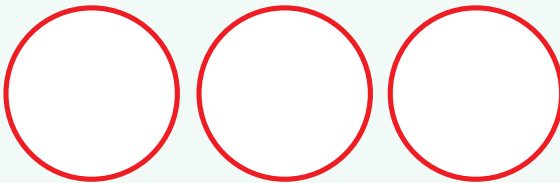
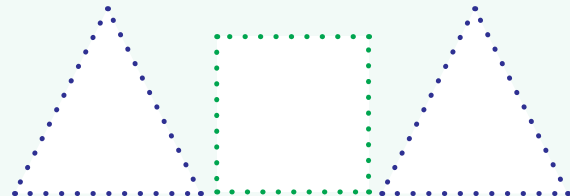
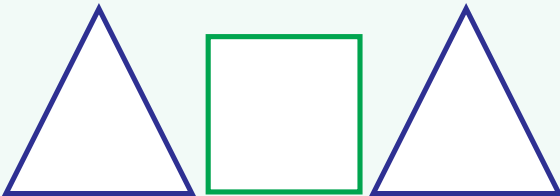
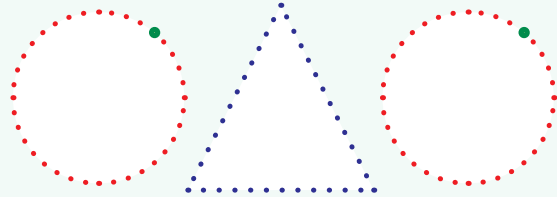
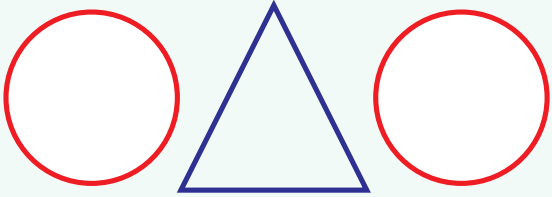

Kilasi yanga

Haseledzani nga ha tshifanyiso.



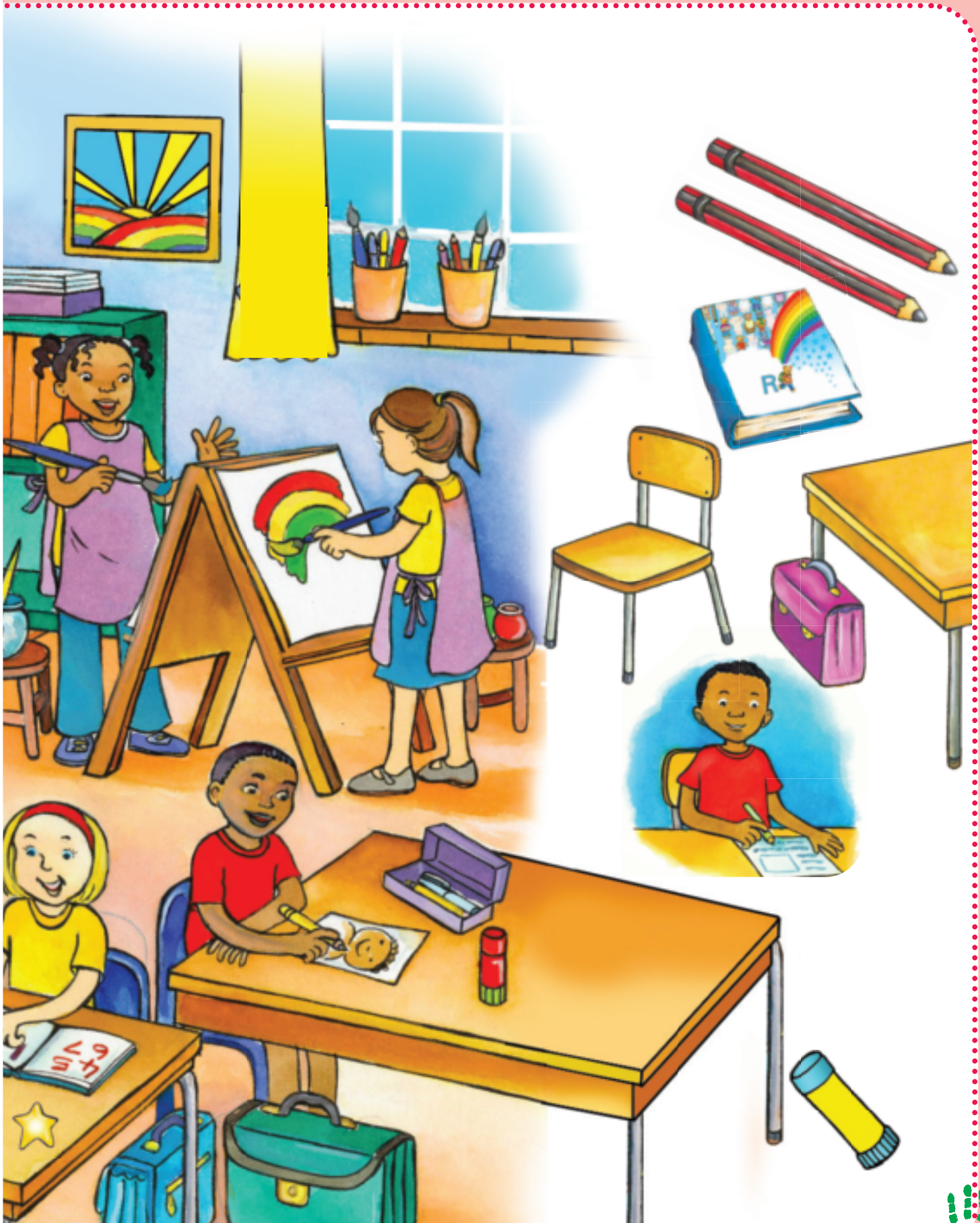



Tevhedzelani thambo, ni thikhe thambo ndapfusa, ni tingeledze thambo pfufhisa.

Themo ya 1 – Vhege dza 1-5

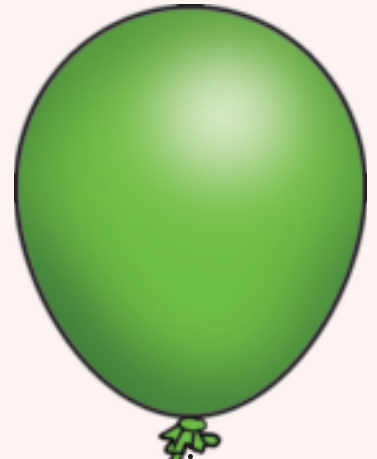
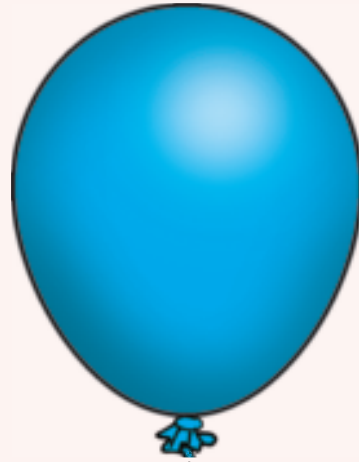
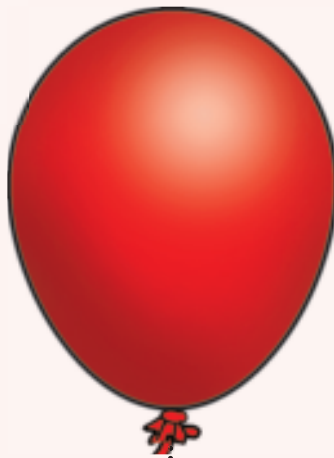
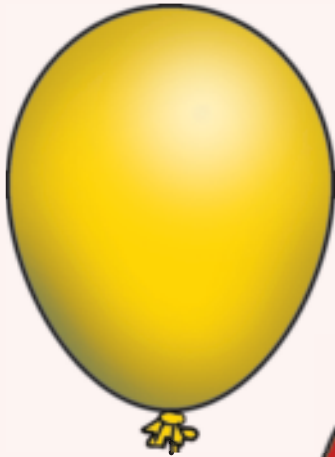

3.2



Vhalelani ni tingedzele hu re na zwithu ziwihili. Tevhedzeleni nomboro 2.

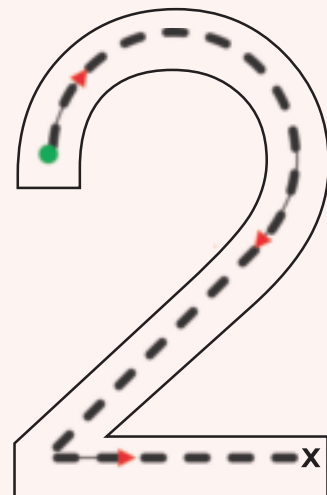
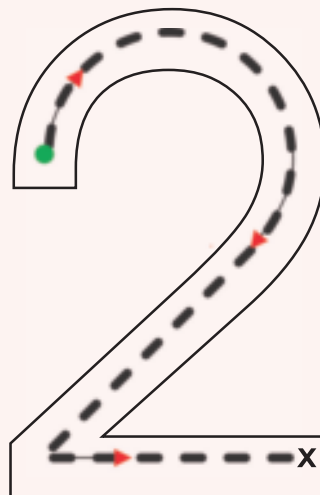
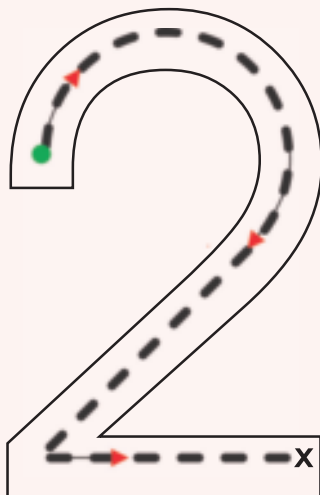



Khaḷarani zwithu zwivhili kha muduba muḥwe na muḥwe.

Themo ya 1 – Vhege dza 1-5

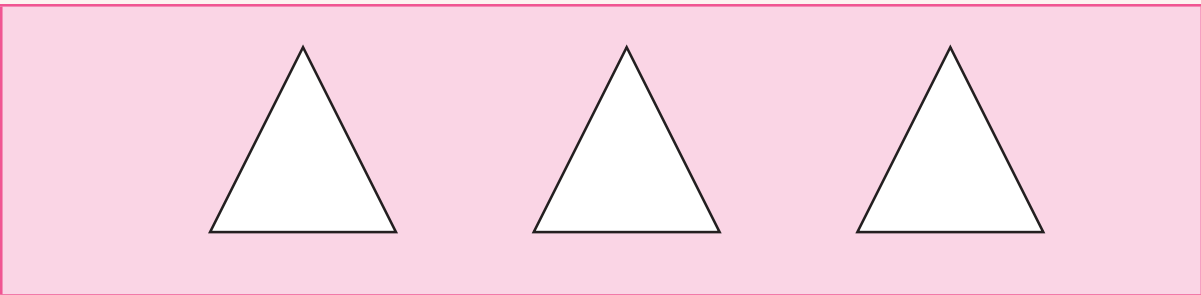
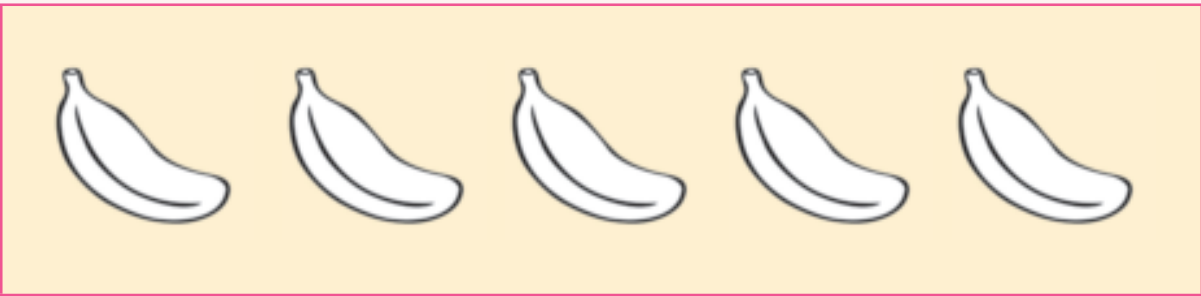
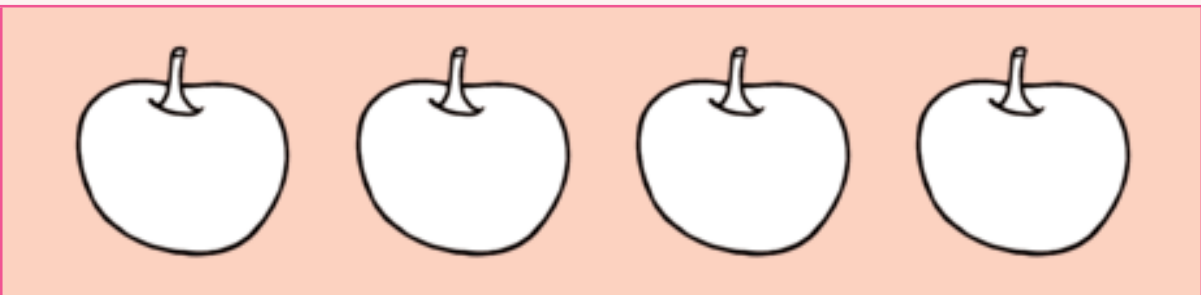

3.4



Ambani nga ha rothini ya maduvha othe tshikoloni.





Nambatedzani zwithu kha mukhwama waṅu.

Themo ya 1 – Vhege dza 1-5



3.6



Tevhedzelani ngila idzi.

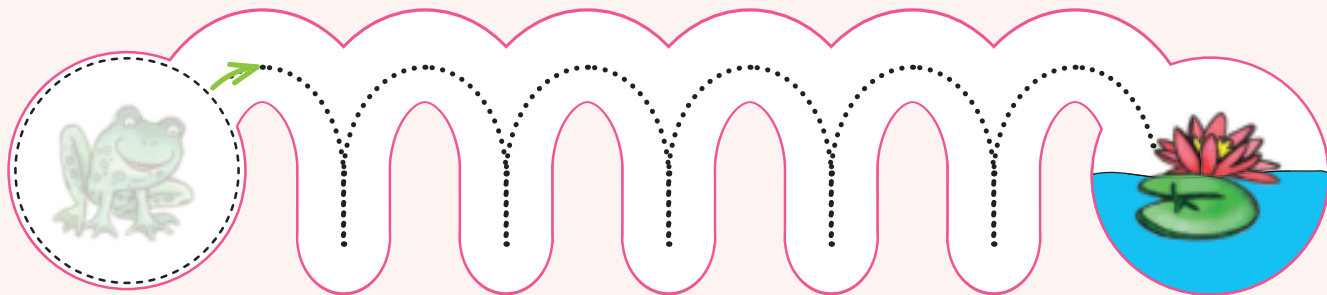
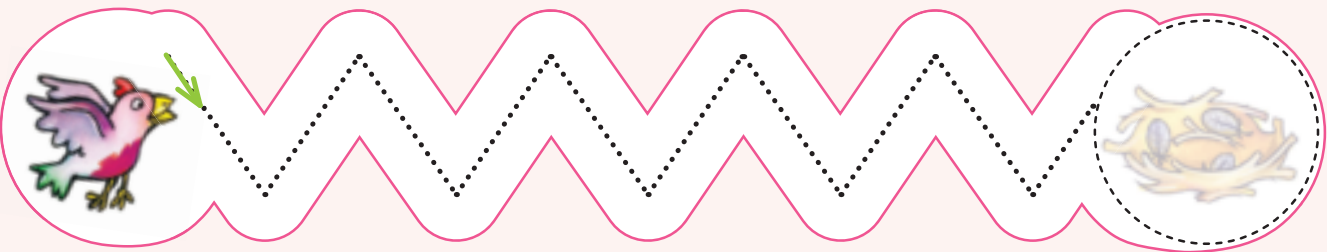
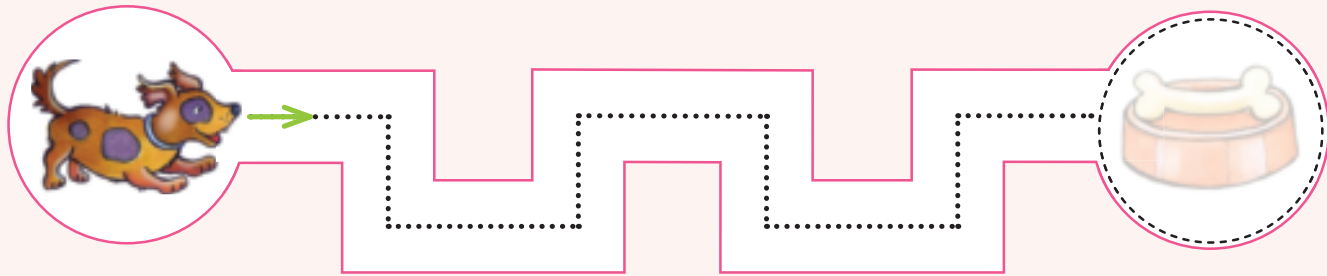
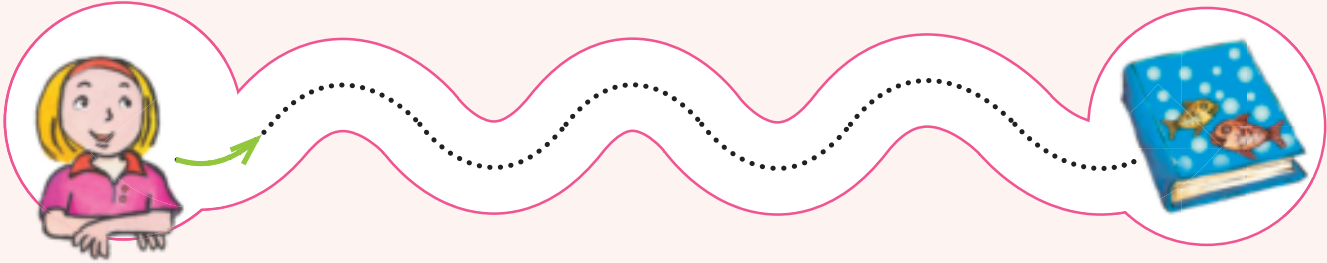

Kutshilele ku re na mutakalo

Themo ya 1 – Vhege dza 6–10

Haseledzani nga ha tshifanyiso.







Tevhedzelani u itela u țanganya zwif anyiso na nyito.

Themo ya 1 – Vhege dza 6–10

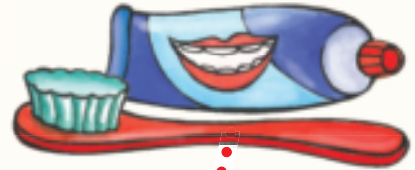
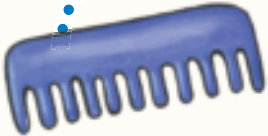

4.2



Tevhedzelani ni khalare tshupu ya tshisibe tsha maṅo na bulatsho ya maṅo.

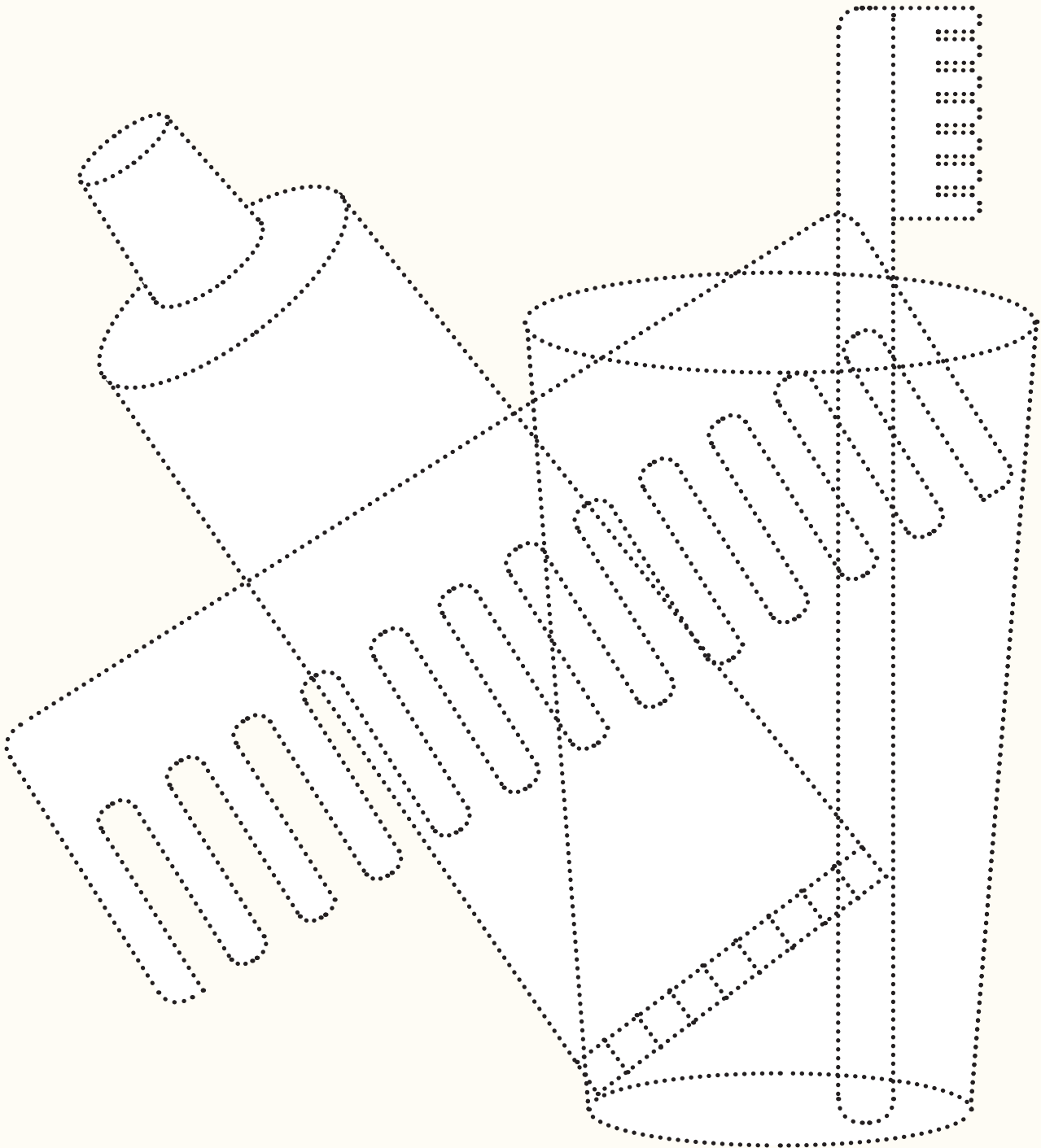



Tingeledzani tshibogisi tshi re na zwithu zwiraru ni tevhedzele nomboro 3.

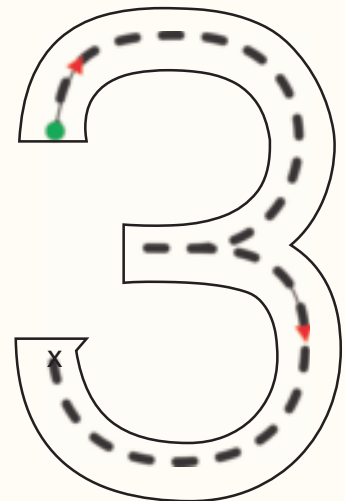
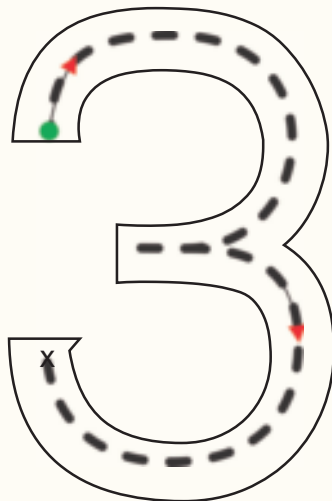
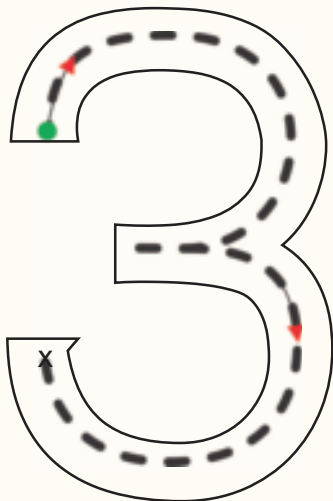
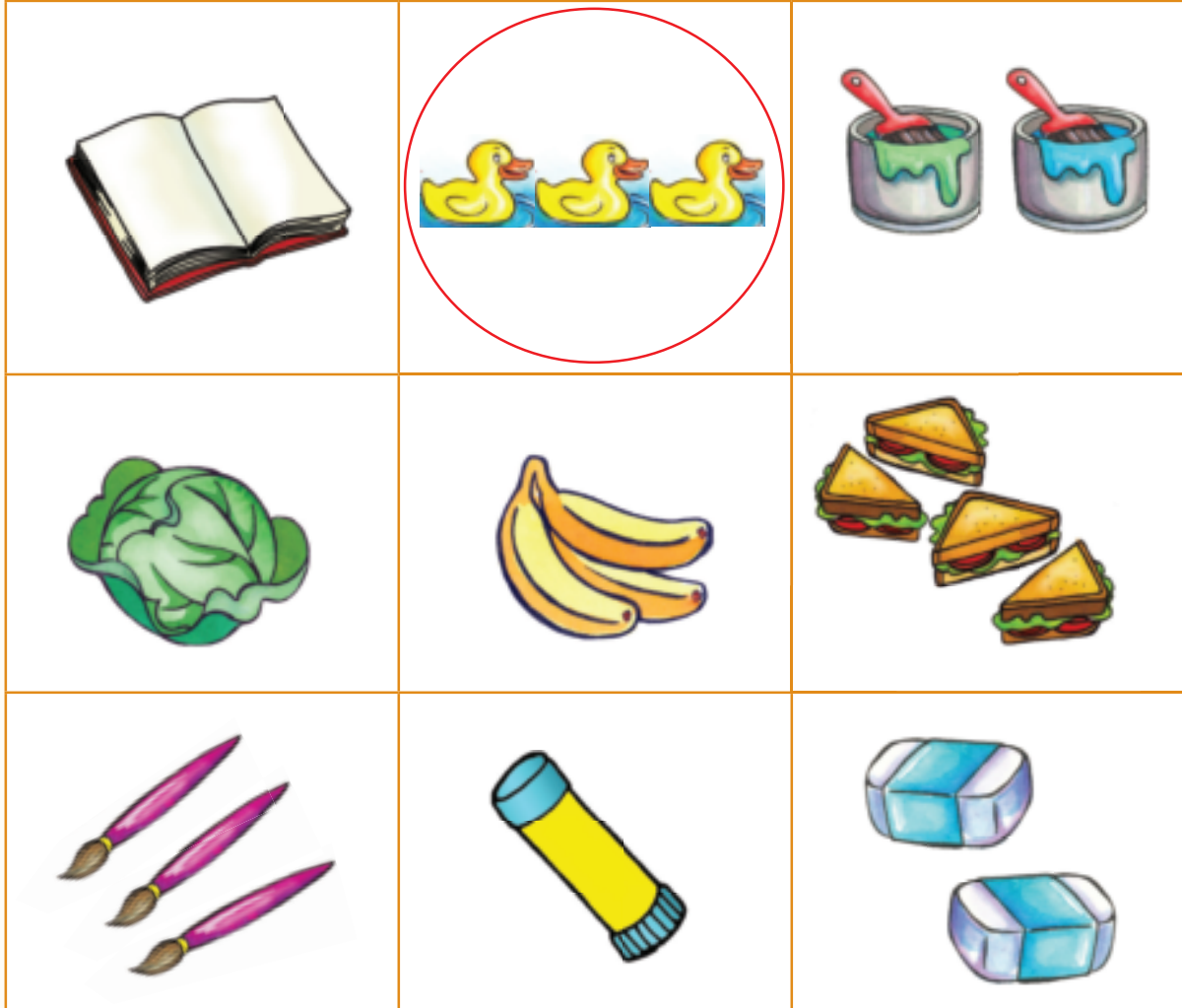

4.4



Gerani kha mitalo ni fhaṭe phazili yaṅu.

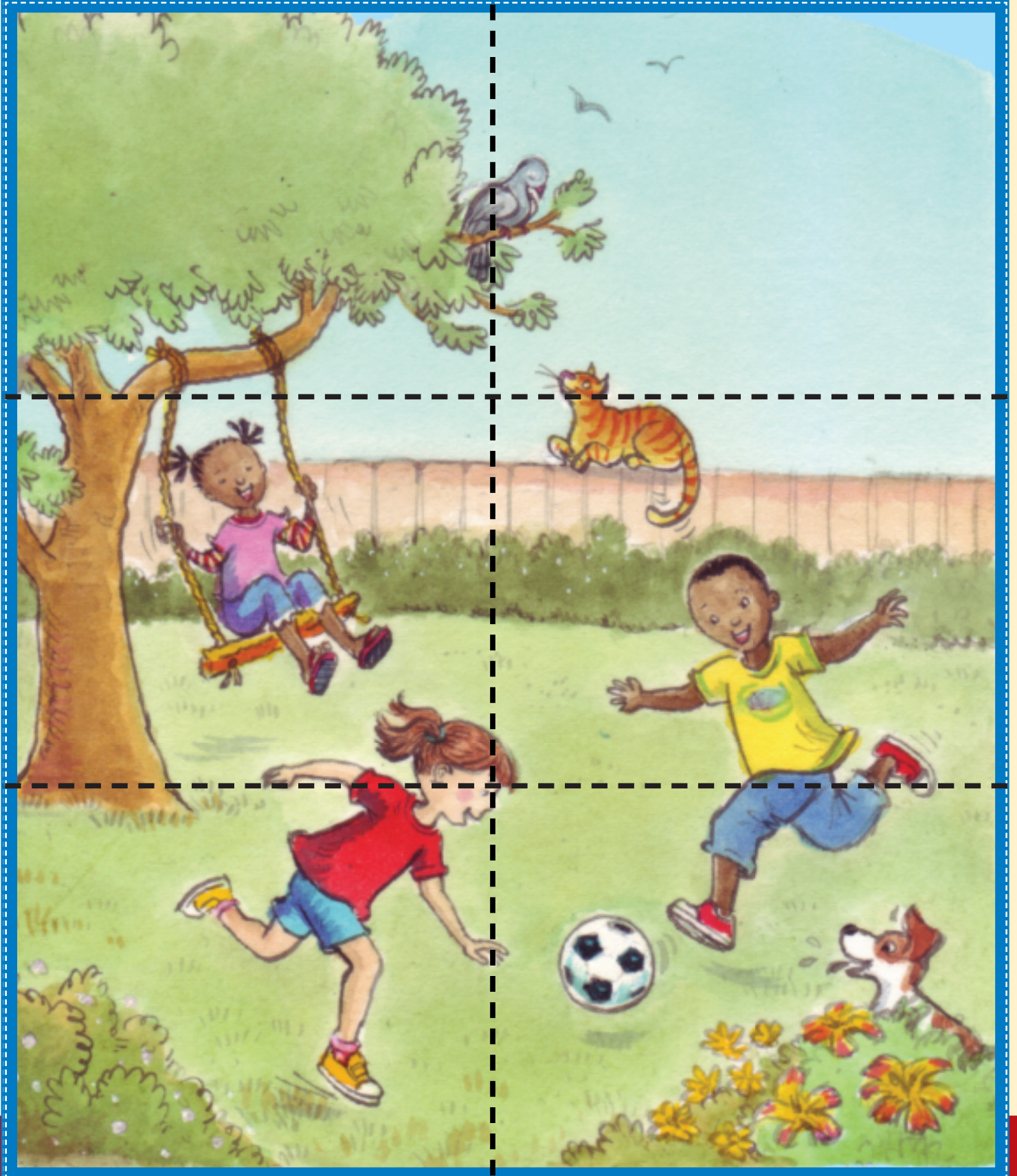

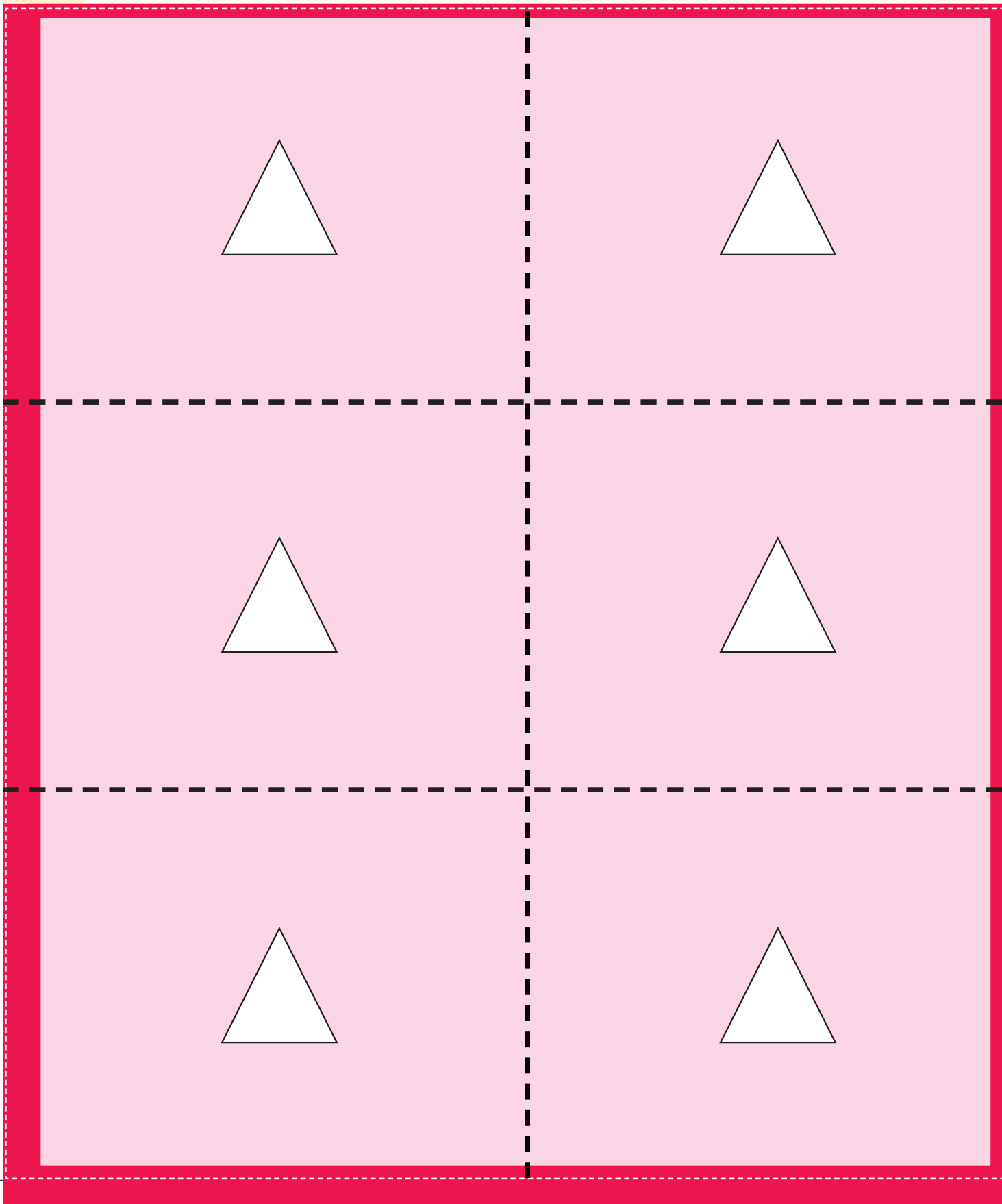
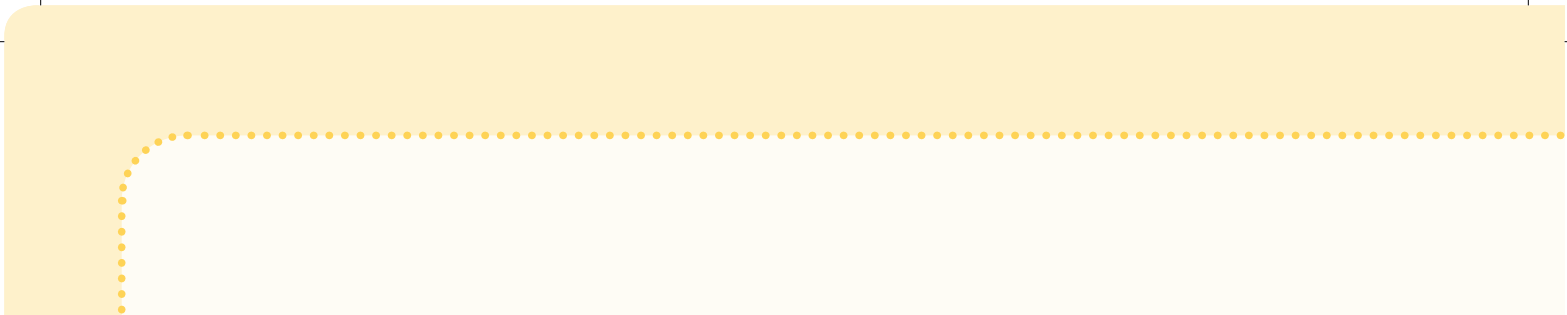



Gerani kha mitalo ni tevhekanye nyito.

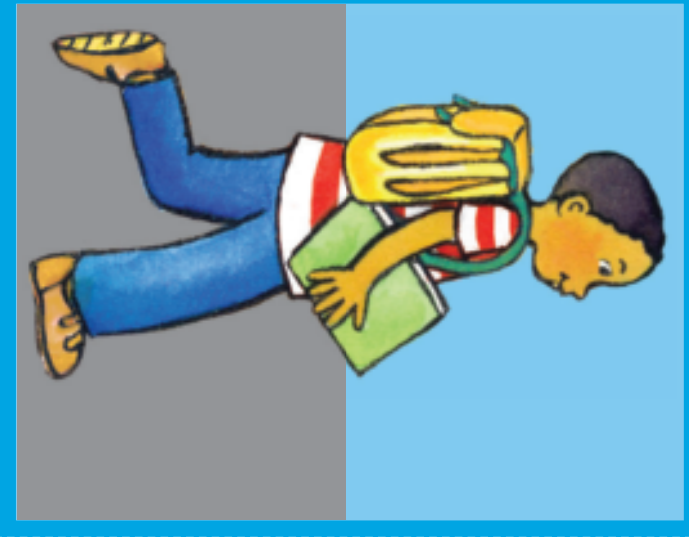

3

2

1

3

2

1

4.6



Vhalelani, ni nambatedze, ni tevhedzele.

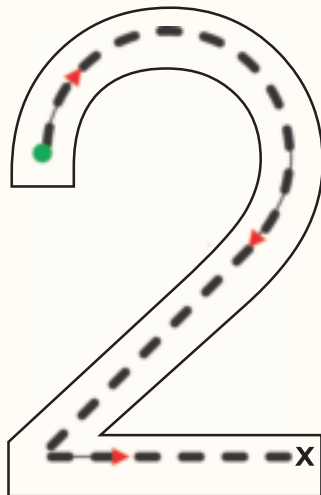
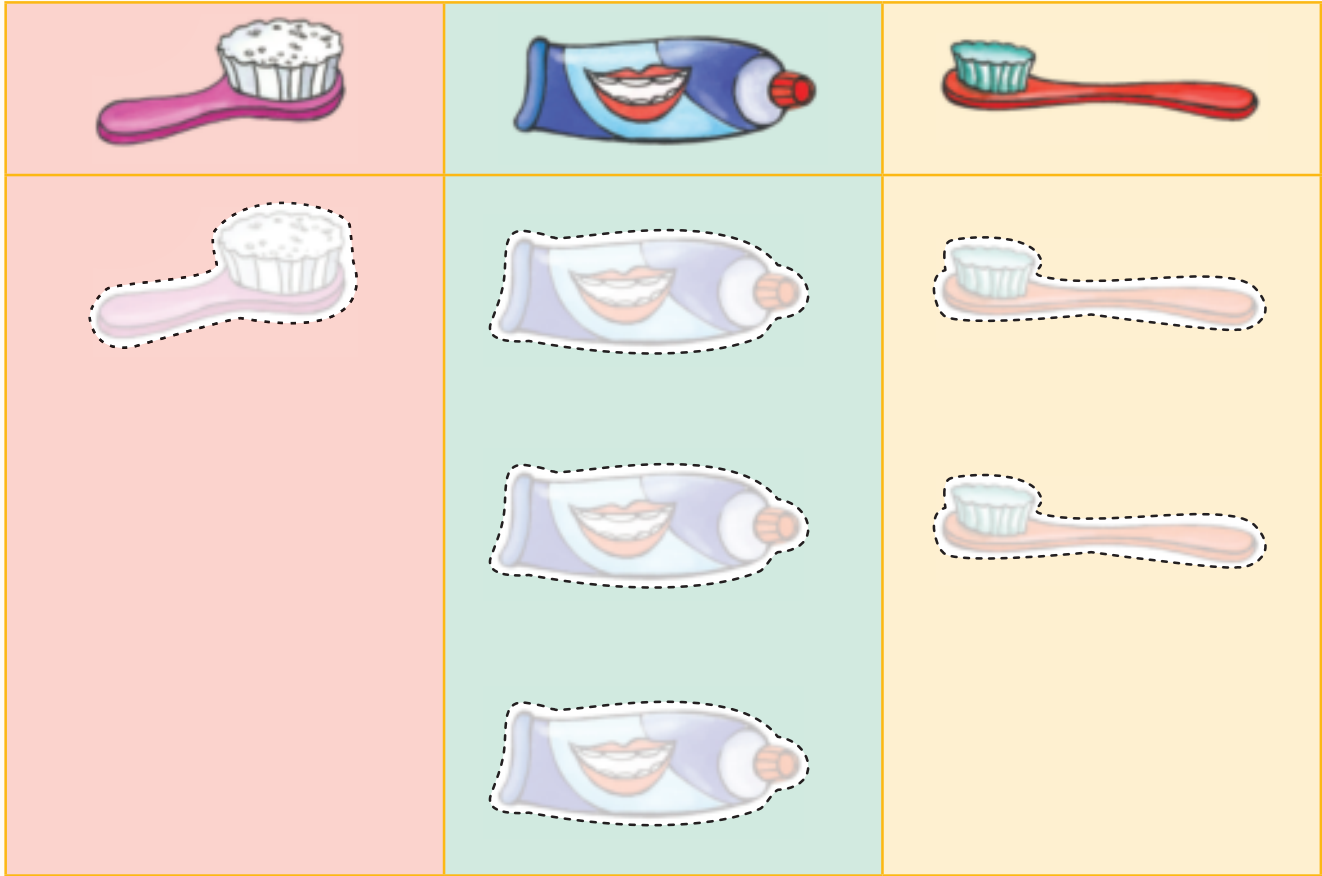

Khonani

Nambatedzani ni haseledze nga ha tshifanyiso.

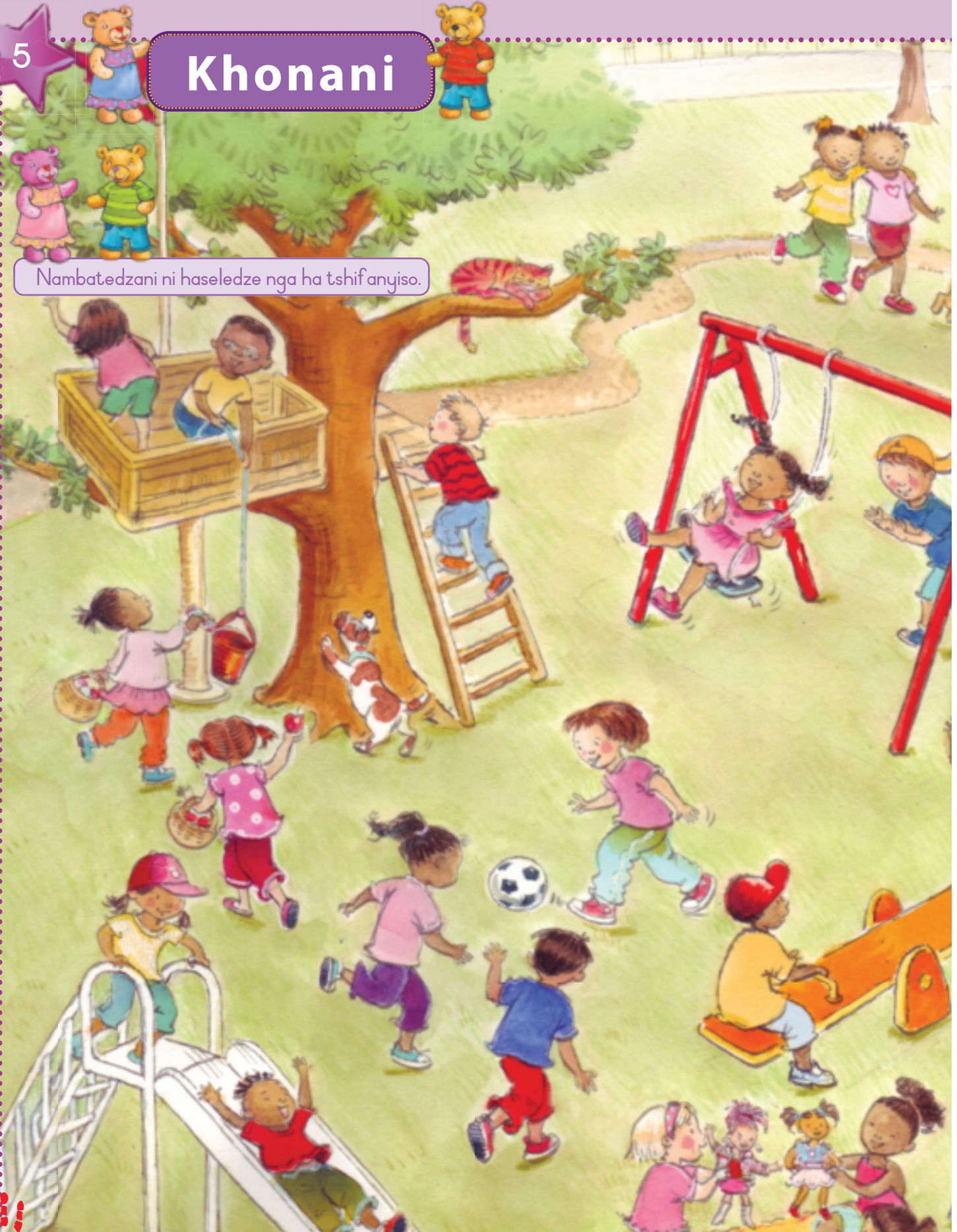





Tingeledzani zwifanyiso zwi fanaho na tsha u thoma.

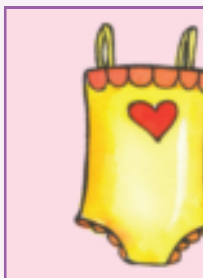



Topolani phambano kha zwif anyiso.





Tevhedzelani ni fanyise zwiambaro.

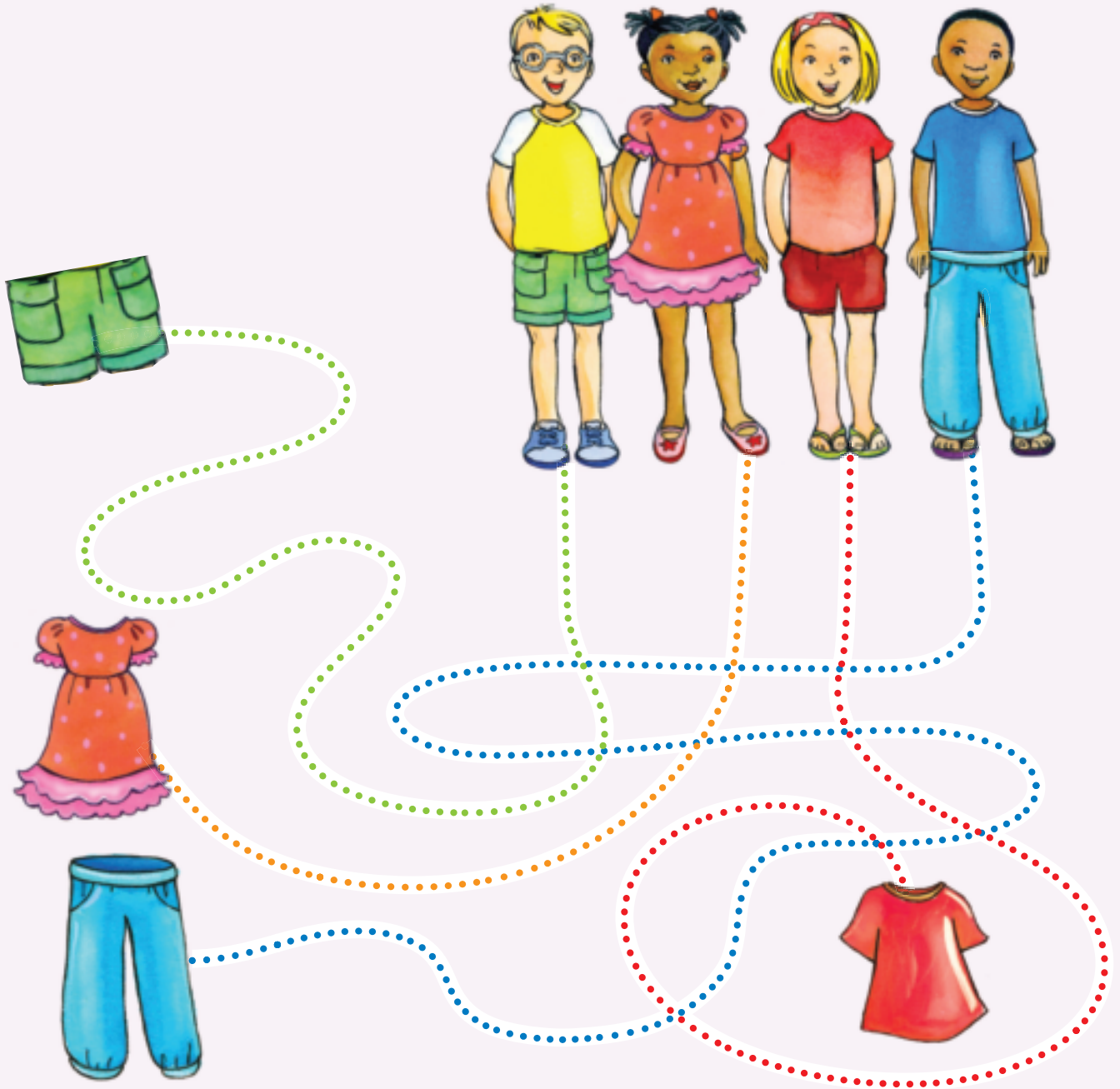



Nambatedzani zwiṭikara ni vhalele uri ndi zwingana.

Tshilimo tsho swika

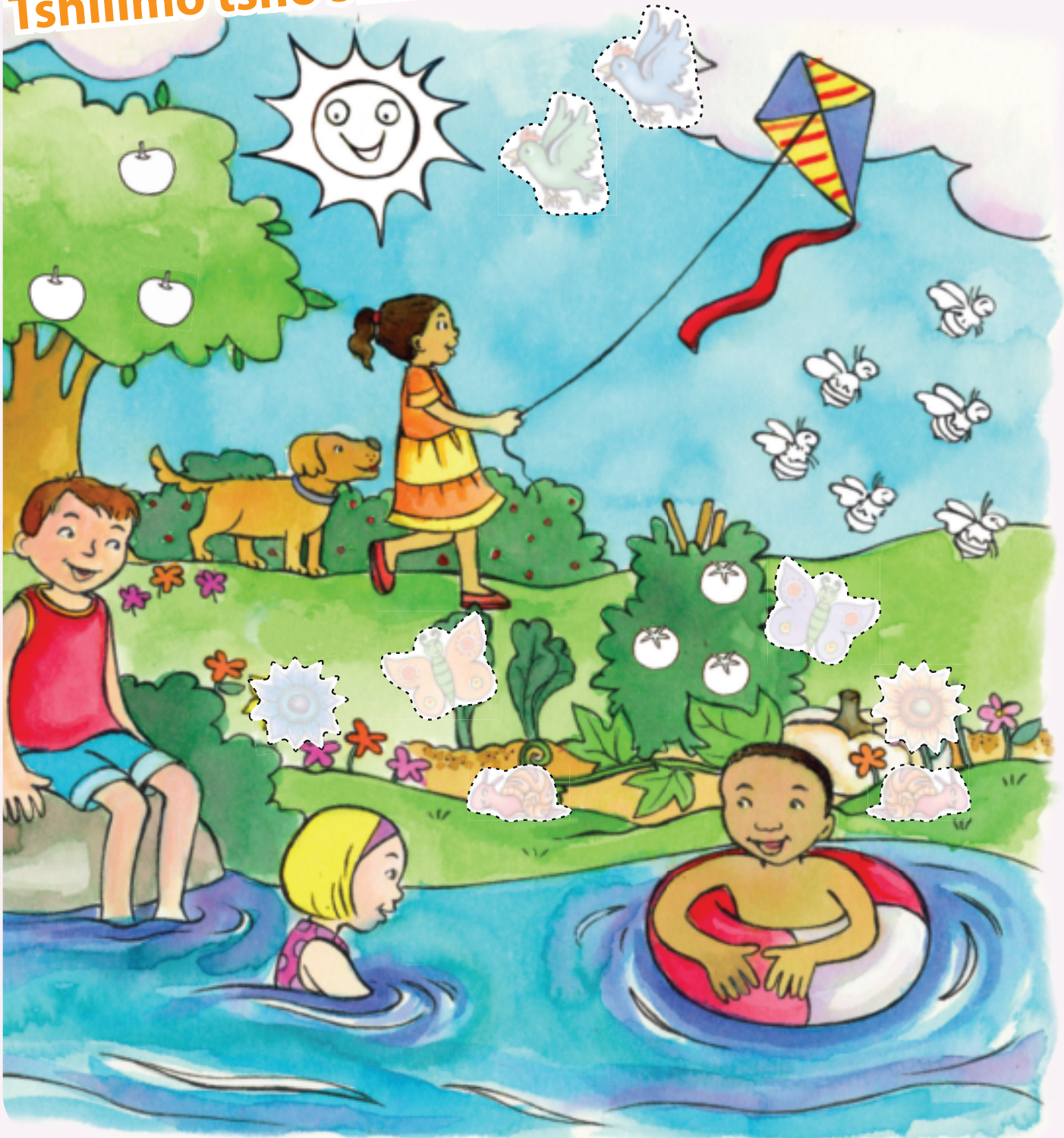



Tingeledzani zwifanyiso zwoṭhe zwa tshilimo.



5.6



Haseledzani nga ha nyito dza tshilimo ni nambatedze zwiṱikara.

u fhisa





Haseledzani nga ha nyito dza vhuria ni nambatedze zwiṱikara.

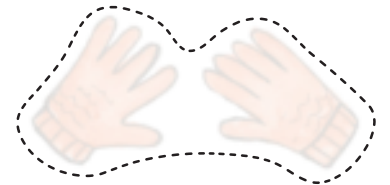



Thusani khonani ni ye kha dzhangili dzhimu, gerani ni nambatedze misevhe.

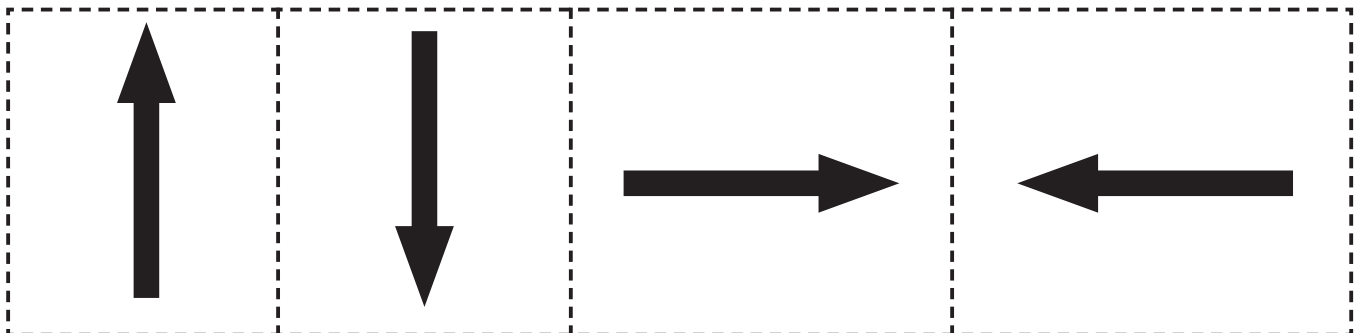
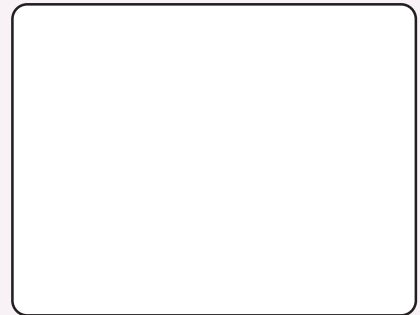



Zwigeriwa



Phaphethe dza minwe:

Nangani tshipuka tshithihi ni n'wale leḁere la u thoma la dzina laḁu kha tshikhipha tshatsho. Zwino n'walani maḁere a u thoma a madzina a khonani dzaḁu kha zwikhipha zwiḁwe.



Phazili dza nomboro:

Gerani kha mitaladzi yo tshukhanyiwaho ni ite garaḁa dza u livhanya nomboro. Ni kone u livhanya zwifanyiso na nomboro dzi re dzone, kana ni zwi livhanye na tshivhalo tsha zwithoma tshi re tshone. Ni nga shumisa zwivhumbeo uri zwi ni thuse.

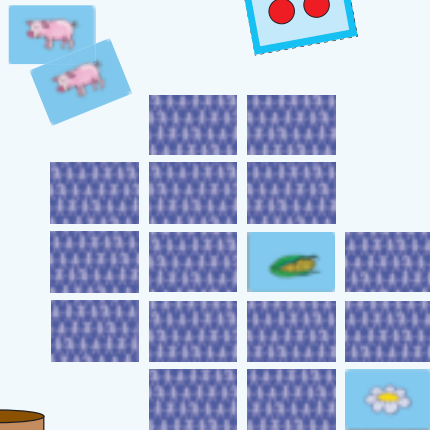

Mutambo wa nyelelwa:

Gerani magaraḁa kha mitaladzi mitswu yo tshukhanyiwaho. Tshovani magaraḁa aya ni a pake nḁha ha tḁafula o sedza fhasi. Zwino rembulusani magaraḁa nga mavhili nga mavhili a tshi sielisana. Arali a tshi yelana (metsha) ni a vhetshela dubo. Wanani uri ndi nnyi ane a ḁo vha wa u thoma u vhetshela magaraḁa oḁhe dubo. Shumisani magaraḁa aḁu a nyelelwa ni tambe mutambo wa zwinepe na khonani yaḁu.

Zwipuka zwa zwikanda zwa thoiletherolo:

Wanani zwikanda zwo fhelaho zwa thoilethetolo. Gerani zwigeriwa zwa rekihithiengele ni zwi nambatedze u mona na zwikanda zwa thoiletherolo ni tshi thivha mabuli. Zwino gerani tshoho ni dzi tome tshodzini dza zwikanda. Shumisani zwitḁikara zwa zwipuka ni nambatedze zwifhaḁuwo kha dziḁhoho u ya nga hune na funa. Nambatedzani milenzhe na mutshila zwa tshipuka nga tshithihi nga tshithihi afha kha zwikanda. Ni nga kha ḁi tou ola zwipuka zwaḁu kana na tou zwi vhumba.

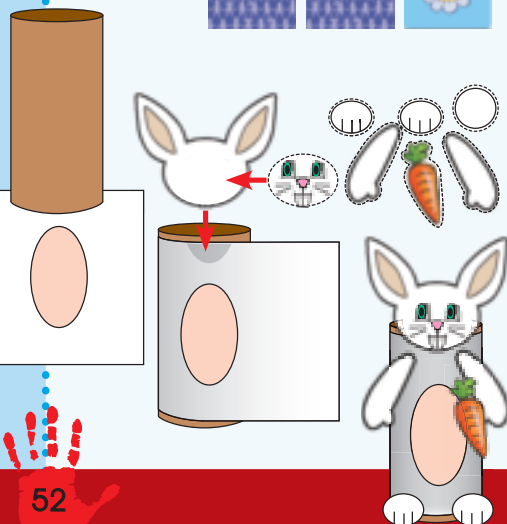

Itani bugu dza masongesonge (zigizaga).
 Petani kha mitalo yo fhelelaho ni gere kha
 mitalo yo t'hukhukanywaho.



Nomboro

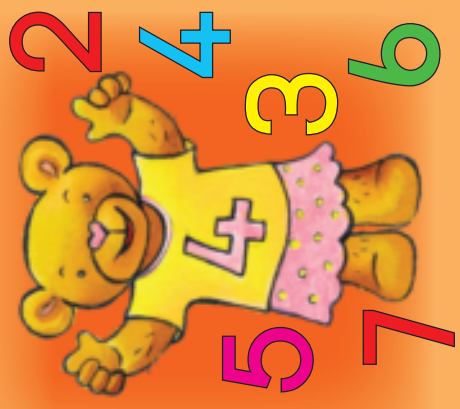

Zwifuwohaya



1

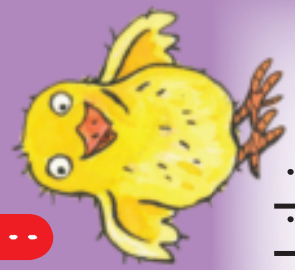

thihi

2

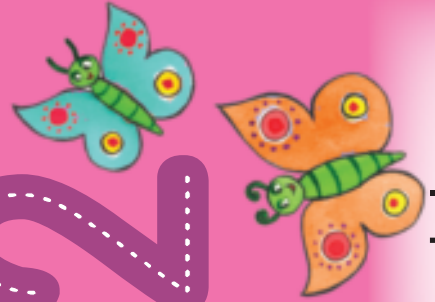

mbili

3



raru



mmbwa



tshimange



khovhe

tswina



ina

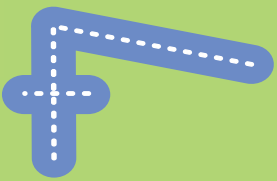
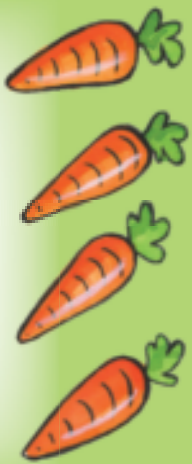

tshinoni

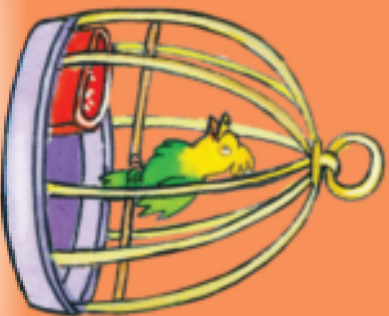

thanu



hemsta



rathi

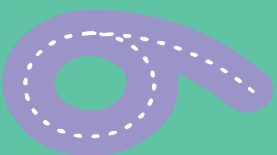

muvhuda



sumbe

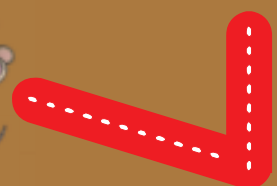
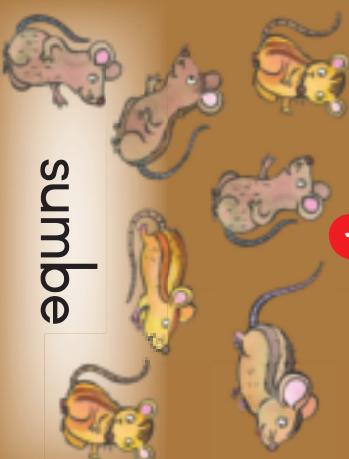



Kha ri ite nyito

Gerani siaṭari kha mutalo wo ṭhukhukanyiwaho ni nambatedze siaṭari kha gwati ḷa murahu uri ni ite tshikwama. Pangani zwigeriwa zwaṅu heneḷha uri zwi si xeḷe.

ZWIGERIWA ZWANGA

NAMBATEDZANI HAFHA

NAMBATEDZANI HAFHA

NAMBATEDZANI HAFHA

NAMBATEDZANI HAFHA

FOLD

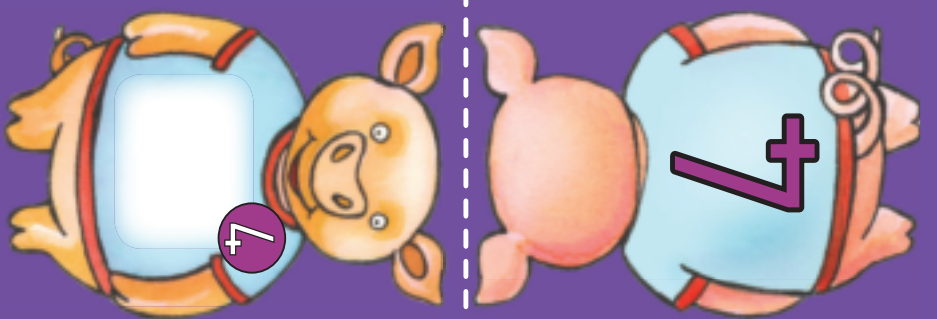

- 0
- 1
- 2
- 3
- 4
- 5
- 6
- 7
- 8
- 9
- 10
- 11
- 12
- 13
- 14
- 15
- 16
- 17
- 18
- 19
- 20
- 21
- 22
- 23
- 24
- 25
- 26
- 27
- 28
- 29

a b c d e f g h i j k l m n o p q r s t u v w x y z

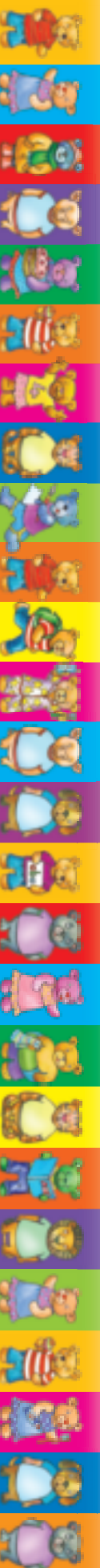

0	a	1	b	2	c	3	d	4	e	5	f	6	g	7	h	8	i	9	j	10	k	11	l	12	m	13	n	14	o	15	p	16	q	17	r	18	s	19	t	20	u	21	v	22	w	23	x	24	y	25	z	26	27	28	29
---	---	---	---	---	---	---	---	---	---	---	---	---	---	---	---	---	---	---	---	----	---	----	---	----	---	----	---	----	---	----	---	----	---	----	---	----	---	----	---	----	---	----	---	----	---	----	---	----	---	----	---	----	----	----	----

GLUE HERE

GLUE HERE

GLUE HERE

GLUE HERE

GLUE HERE

GLUE HERE

GLUE HERE

GLUE HERE

GLUE HERE

GLUE HERE



1

1

2

2

3

3

4

4

5

5







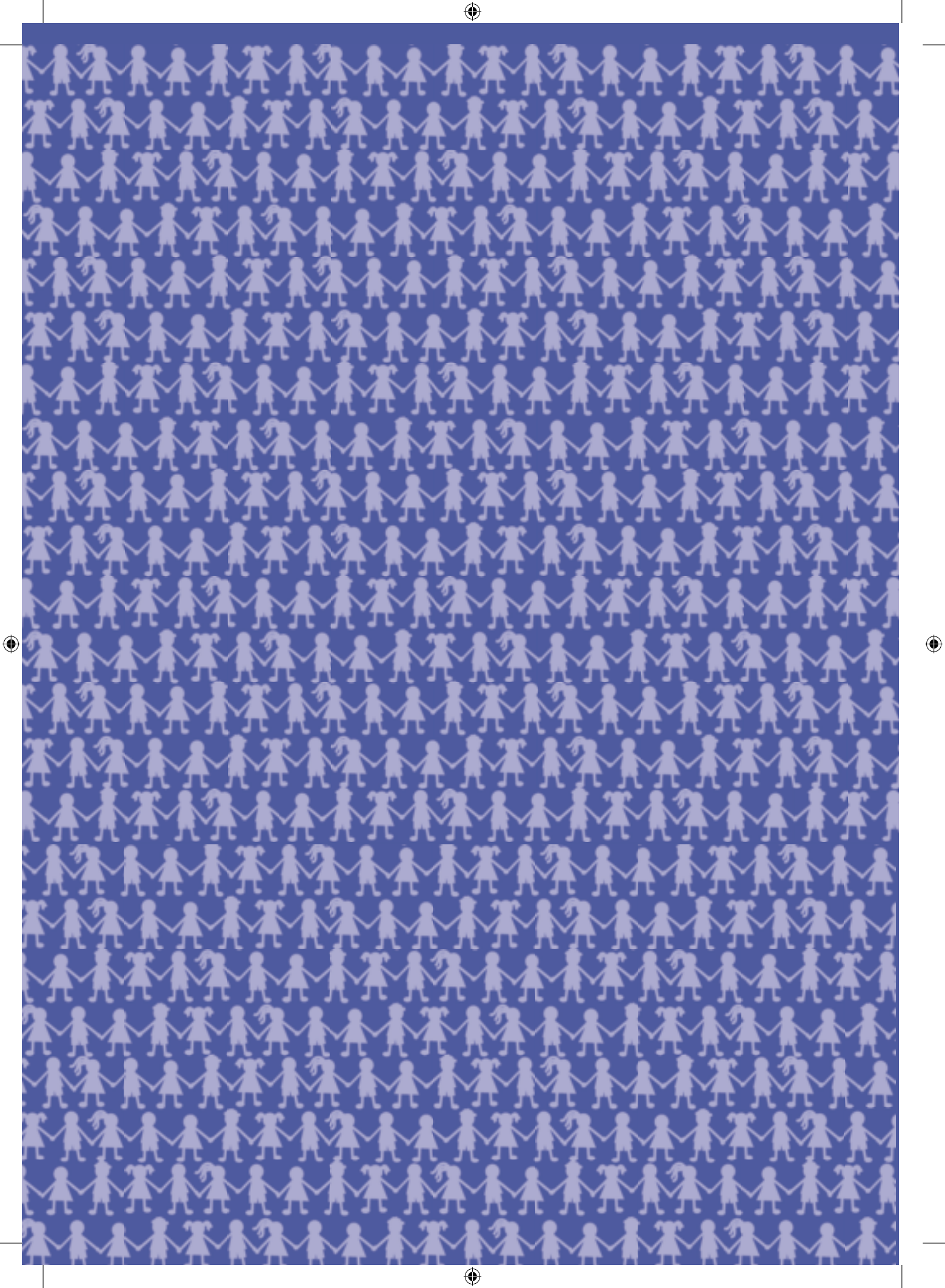

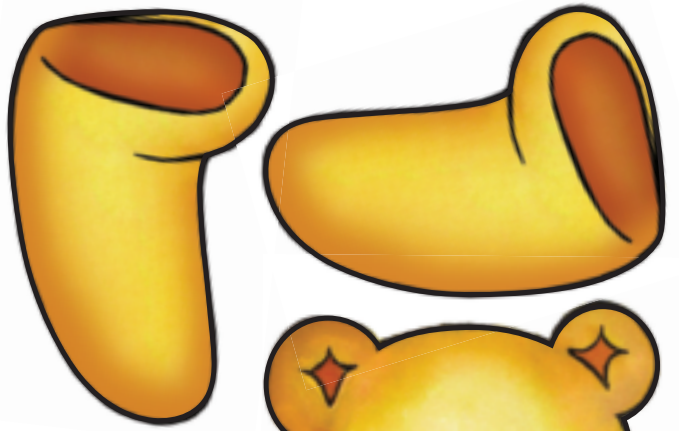
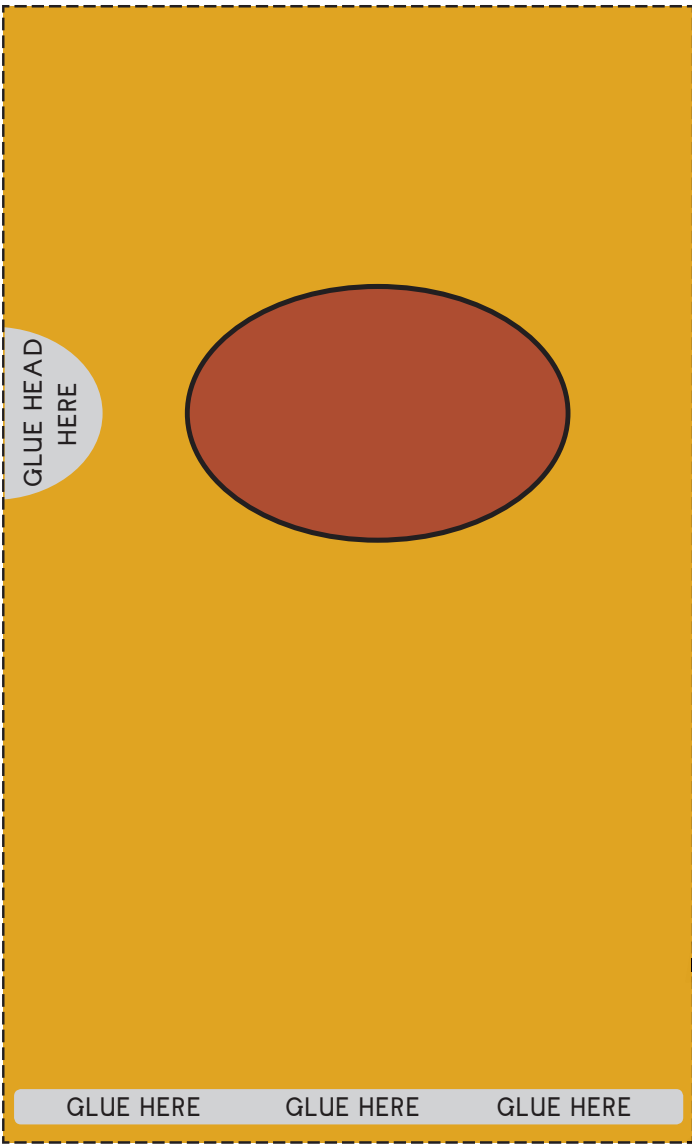

TEDDY BEAR

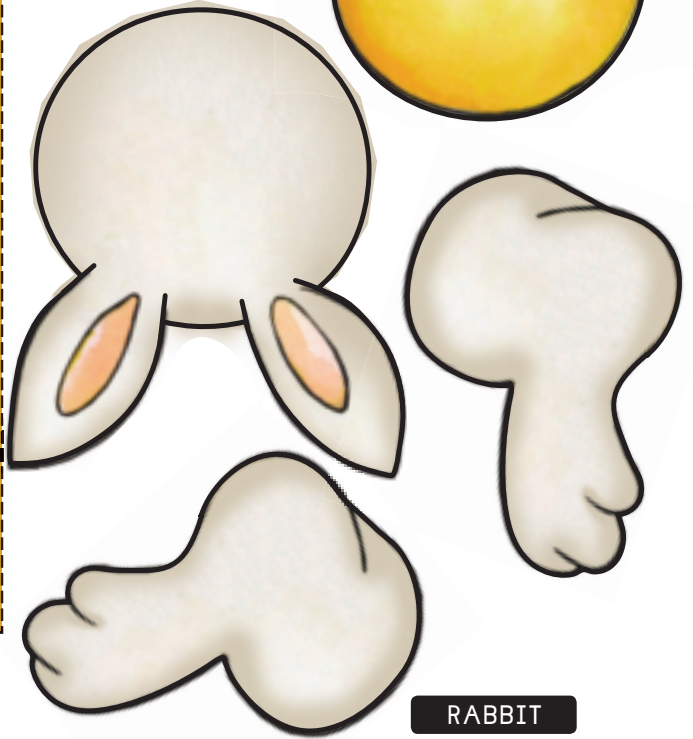

RABBIT

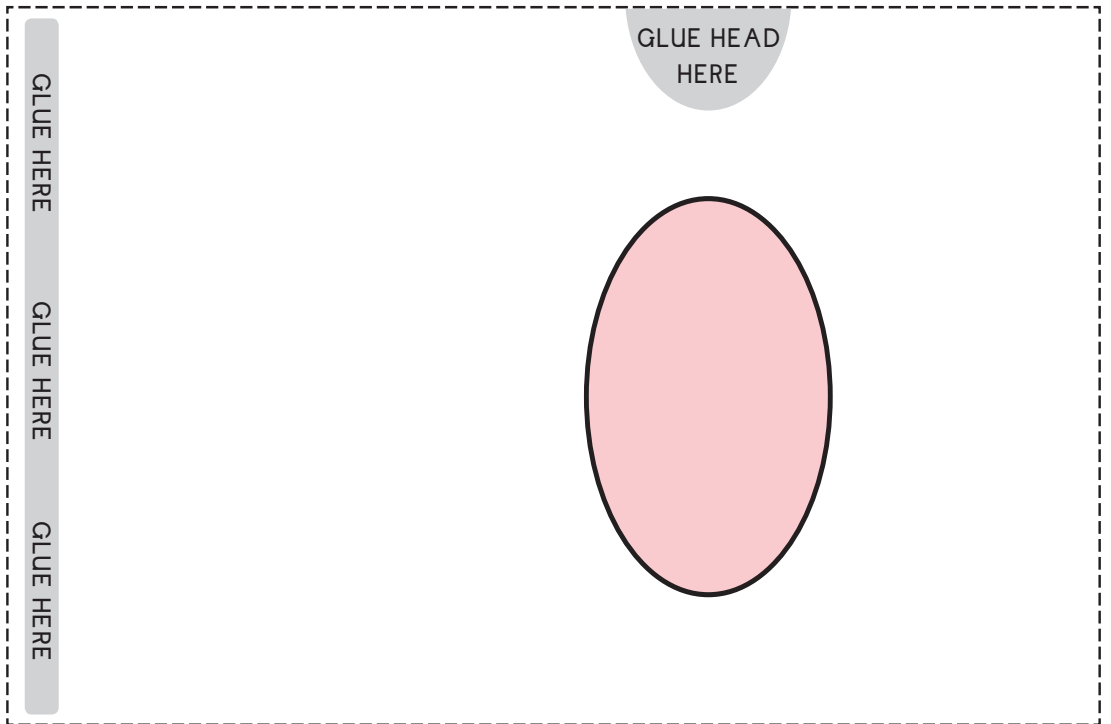

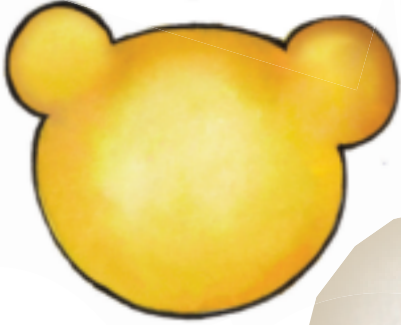
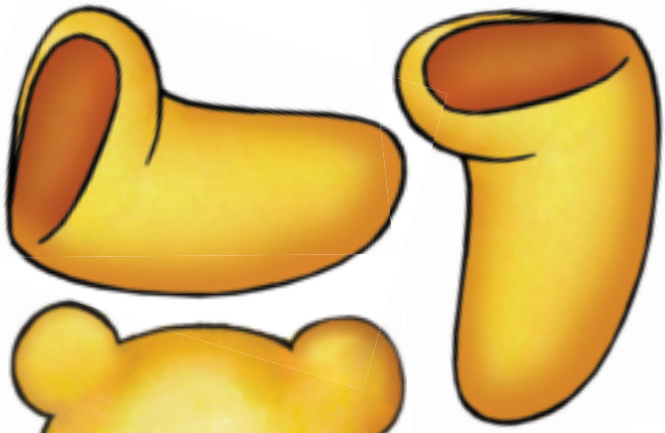

STICKERS

GRADE R BOOK1

8



6



12



20



30

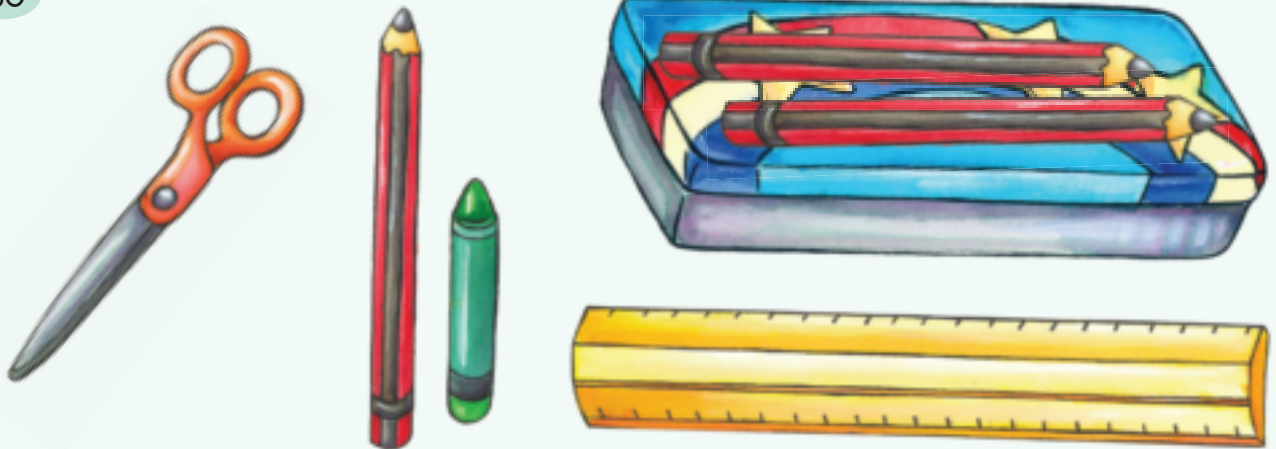

31



43



47



49-50



TEDDY BEAR

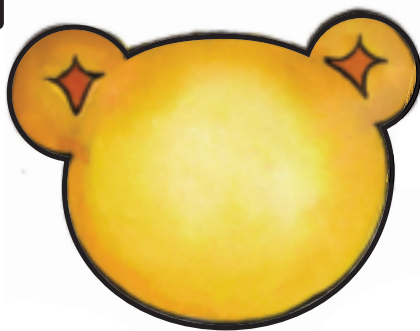

ARMS

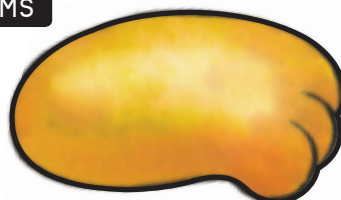
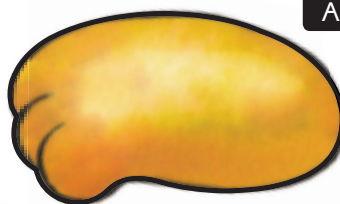

NOSES & MOUTHS

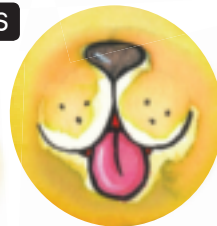

TAILS

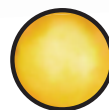
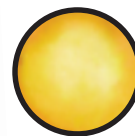

EYES

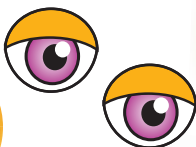

FACES



ARMS

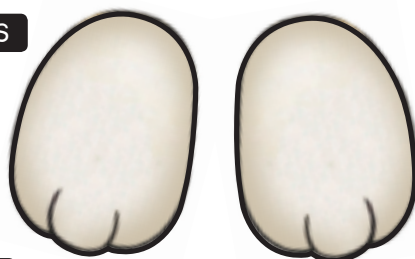
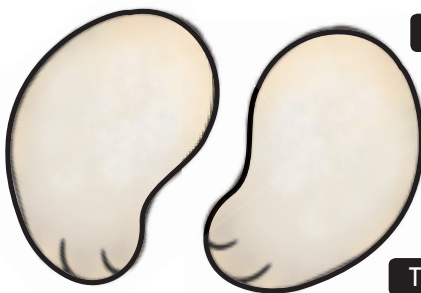

TAILS



EYES



FACES

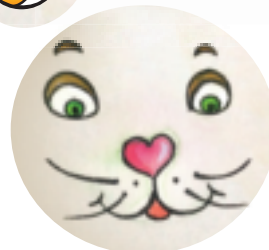

RABBIT

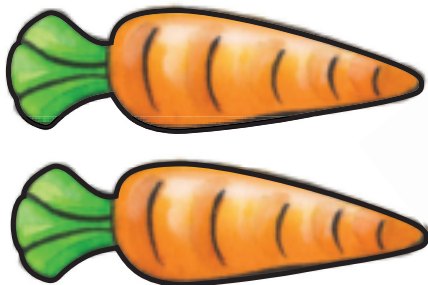

12

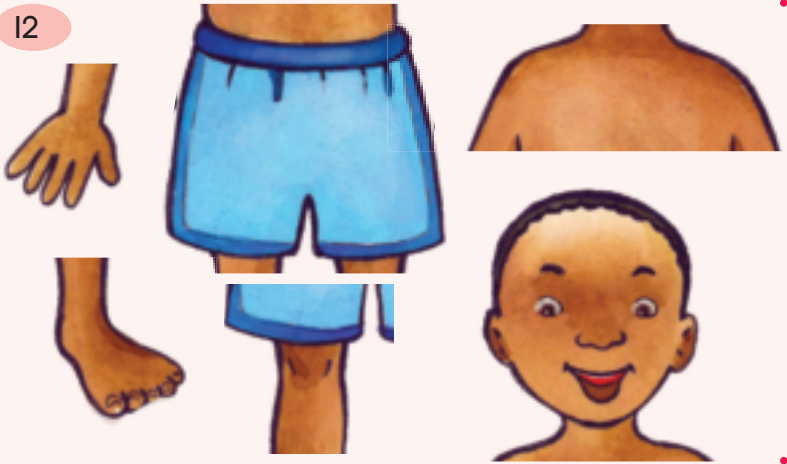

33



30



41

