

I'M THE BOSS OF MY BODY! STOP SEXUAL ABUSE!

STOP! RUN! TELL! REPORT!

STOP SEXUAL ABUSE!



STOP TOUCHING ME!



RUN!



TELL!



REPORT TO POLICE



TALK TO PARENTS
AND EDUCATORS



IT IS EVERYONE'S RESPONSIBILITY TO
STOP SEXUAL ABUSE



ABUSERS MUST
BE REPORTED
AND DEALT WITH
LAWFULLY!



MATHEMATICS IN ENGLISH – Grade 6 Book 2

ISBN 978-1-4315-0180-9

Revised and
CAPS aligned



Grade 6

MATHEMATICS
IN ENGLISH

Name:

Class:



basic education
Department:
Basic Education
REPUBLIC OF SOUTH AFRICA

Book 2
Terms
3 & 4



ISBN 978-1-4315-0180-9



MATHEMATICS IN ENGLISH
GRADE 6 – BOOK 2 • TERMS 3 & 4
ISBN 978-1-4315-0180-9
THIS BOOK MAY NOT BE SOLD.
14th Edition

Contents

No.	Topic	Page
65	Measuring instruments for mass and weight	2
66a	Weight	4
66b	Weight (continued)	6
67	Mass and capacity	8
68a	Solving problems with mass	10
68b	Solving problems with mass (continued)	12
69a	Number work up to 9-digits	14
69b	Number work up to 9-digits (continued)	16
70	Rounding off	18
71a	Addition problems with up to 5-digit numbers	20
71b	Addition problems with up to 5-digit numbers (continued)	22
72a	Subtraction problems with up to 5-digit numbers	24
72b	Subtraction problems with up to 5-digit numbers (continued)	26
73	Solving money problems	28
74	More about money problems	30
75a	Addition with up to 6-digit numbers	32
75b	Addition with up to 6-digit numbers (continued)	34
76a	Subtraction with up to 6-digit numbers	36
76b	Subtraction with up to 6-digit numbers (continued)	38
77a	Addition and subtraction	40
77b	Addition and subtraction (continued)	42
78	More addition and subtraction	44
79a	Views	46
79b	Views (continued)	48
80	Regular and irregular polygons	50
81	Right angles	52
82	Angles bigger or smaller than 90	54
83	Reflection, rotation and translation	56
84a	Enlargement and reduction	58
84b	Enlargement and reduction (continued)	60
85a	Temperature	62
85b	Measuring temperature	64
86	Temperature scales and display	66
87	Percentage and fractions	68
88	Percentage and decimals	70
89	Percentages of a whole number	72
90	Percentages and money	74
91	Tally marks and frequency tables	76
92a	Grouping and ordering data	78
92b	Grouping and ordering data (continued)	80
93	Pictographs	82
94	Pie charts	84
95	Graphs	86
96	Mean, median and mode	88
97	Sequence of numbers	90
98	Flow diagrams and tables	92
99	Measuring instruments	94
100a	Converting between lengths	96
100b	Converting between lengths (continued)	98
101	Round off length	100
102	Measurement problem solving	102
103	Kilometres	104
104	More on kilometres	106
105a	Numbers 0 - 1 000 000	108
105b	Numbers 0 - 1 000 000 (continued)	110
106a	Multiplication: more 3-digit by 3-digit	112
106b	Multiplication: more 3-digit by 3-digit (continued)	114
107	Multiples	116
108	Multiplication 4-digit by 3-digit	118
109	Factors and multiples	120
110a	Multiplication and rounding off	122
110b	Multiplication and rounding off (continued)	124
111	Multiplication and the distributive property	126
112a	Multiplication and the vertical method	128
112b	Multiplication and the vertical method (continued)	130
113	Ratio	132
114	Proportional sharing	134
115	Fractions: mixed numbers	136
116	Fractions: more mixed numbers	138
117	All about fractions	140
118	Equivalent fractions	142
119	Addition and subtraction of common fractions	144
120a	Fraction problem solving	146
120b	Fraction problem solving (continued)	148
121	Faces, vertices and edges	150
122	3-D objects	152
123a	Square units and area	154
123b	Area and perimeter	156
124	Volume	158
125a	Perimeter, length and width	160
125b	Perimeter, length and width (continued)	162
126	Division and remainders	164
127a	More division	166
127b	More division (continued)	168
128	Division: 4-digit by 2-digit	170
129a	Division: 4-digit by 2-digit numbers	172
129b	Division: 4-digit by 3-digit numbers with remainders	174
130	Properties of number	176
131	Order of operations	178
132	Basic operations	180
133a	More properties of numbers	182
133b	More properties of numbers (continued)	184
134a	Even more properties of numbers	186
134b	Even more properties of numbers (continued)	188
135	Properties of number again	190
136	Transformations: reflection, rotation and translation	192
137a	Reflection: flip, turn and slide	194
137b	Reflection	196
138a	Rotation: turn	198
138b	Translation: slide	200
138c	Flip, turn and slide	202
139	Transformations and tangrams	204
140	Position on a map grid	206
141	Shapes on grids	208
142a	Perspective	210
142b	Perspective (continued)	212
143	Outcomes of two dice	214
144	Outcomes of two cards	216



Mrs Angie Motshekga,
Minister of
Basic Education



Dr Reginah Mhaule,
Deputy Minister of
Basic Education

These workbooks have been developed for the children of South Africa under the leadership of the Minister of Basic Education, Mrs Angie Motshekga, and the Deputy Minister of Basic Education, Dr Reginah Mhaule.

The Rainbow Workbooks form part of the Department of Basic Education's range of interventions aimed at improving the performance of South African learners in the first six grades. As one of the priorities of the Government's Plan of Action, this project has been made possible by the generous funding of the National Treasury. This has enabled the Department to make these workbooks, in all the official languages, available at no cost.

We hope that teachers will find these workbooks useful in their everyday teaching and in ensuring that their learners cover the curriculum. We have taken care to guide the teacher through each of the activities by the inclusion of icons that indicate what it is that the learner should do.

We sincerely hope that children will enjoy working through the book as they grow and learn, and that you, the teacher, will share their pleasure.

We wish you and your learners every success in using these workbooks.





Grade **6**

M **a** **t** **h** **e** **m** **a** **t** **i** **c** **s**

PART
3
WORKSHEETS
65 to 144

Name:

ENGLISH
Book
2

Measuring instruments for mass and weight

What would you weigh with these scales? Are they analogue or digital scales?

a.



b.



c.







d.



Term 3

1. What would you weigh with the following measuring instruments?
Would you weigh it in kilograms or grams?

Type	For measuring:	Kilograms or grams
Bathroom scale 	<hr/> <hr/> <hr/> <hr/>	<hr/> <hr/> <hr/> <hr/>
Balance scale 	<hr/> <hr/> <hr/> <hr/>	<hr/> <hr/> <hr/> <hr/>
Kitchen scale 	<hr/> <hr/> <hr/> <hr/>	<hr/> <hr/> <hr/> <hr/>
Spring scale 	<hr/> <hr/> <hr/> <hr/>	<hr/> <hr/> <hr/> <hr/>



We use **scales** to measure **mass** and **weight**. Most people use both words as if they are the same, though they are different. The **mass** of an object is how much matter it contains. It does not change. The **weight** of an object changes according to gravity. An object weighs six times more on earth than on the moon, and weighs nothing in empty space, even though its mass remains the same everywhere.

A **balance scale** measures **mass**. A **spring scale** measures **weight**. On earth both types of scale give us the same approximate reading, so for everyday practical activities we can also use spring scales (such as bathroom and kitchen scales) to measure mass.

2. How would you measure the mass of the following (with what instrument and in grams or kilograms)?

a. A bunch of bananas:

b. Sugar for a cake recipe:

c. A child visiting the clinic:

d. A laptop computer:

3. Answer the following questions.

a. We make use of scales to weigh objects.

- Is there only one type of scale? _____
- Name some of the types of scales we use and what we use them for.

b. Will a bag full of cotton waste have a larger mass than the same size bag half filled with steel nails? _____

c. We use grams (g) and kilograms (kg) when measuring mass.

- Which unit of measurement do you think we use to measure heavier objects? _____
- Which unit of measurement do you think we use for lighter objects? _____

Measuring the ingredients

My mother baked a cake. What did she use to measure the ingredients?

Sign:

Date:



What is a scale? Circle all the measuring instruments used to weigh objects.

What would you weigh with each of those measuring instruments?



1. What do we weigh with measuring instruments?

Measuring instrument	Give an example what you can weigh with it
Spring scale	Meat

2. Answer the following:

a. How many grams are there in a kilogram?

b. How many grams are there in 2,4 kilograms?

c. How many grams are there in 100 kilograms?

d. How many kilograms is 23 500 grams?

e. How many kilograms is 48 250 grams?

3. What do you see around you that weighs about 1 kilogram?
(You may not answer, "1 kilogram packet of sugar etc."!).

4. Look at these things. Estimate how much each one weighs.



a. Tennis ball



b. Medium sized dog



c. Car



d. Sport shoes



Sign:

Date:

continued

5. Complete the intervals for this spring balance and number them.

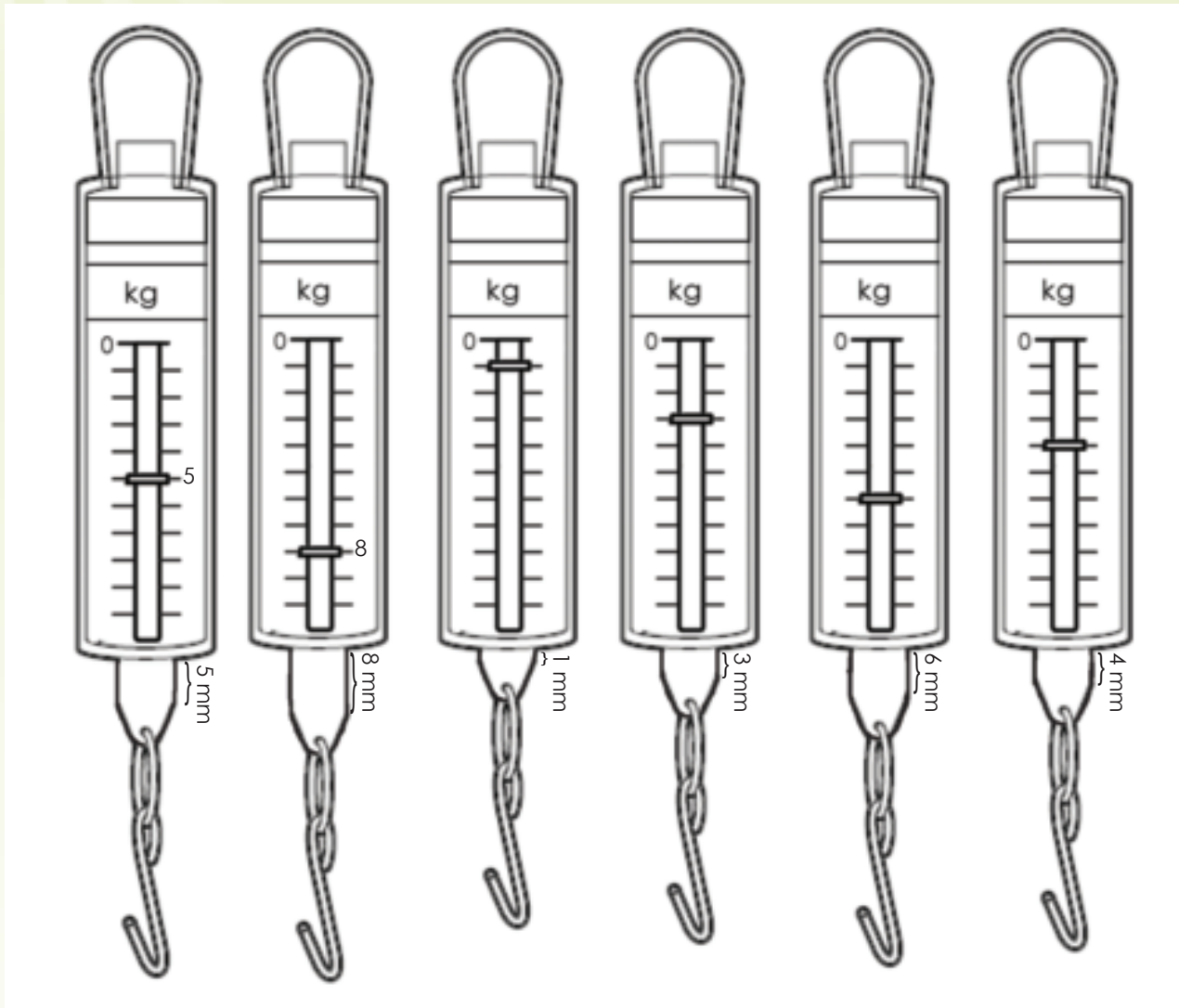

6. What is the reading on each of these spring scales?

i. a. b.

c. d.

c. f.

ii. 1 kg = mm on the spring balance?

iii. Will this be the same for all spring balances?

7. How much does the object weigh on these spring scales?

a. kg
 g

b. kg
 g

c. kg
 g

Make your own scales

You can make your own scales from household objects.

You can make a spring scale using a spring and paper clips.

You can make a balance scale as illustrated here.





Sign:

Date:

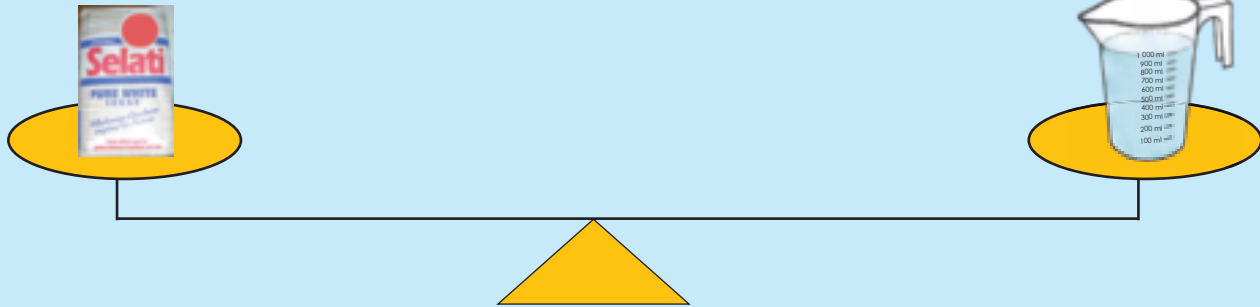
Look at the picture below. Prove that 1 litre water = 1 kg.



1. Circle the most appropriate unit to measure each object.

Mass		Capacity			
Truck		mg g kg	Glass of water		ml litre
Book		mg g kg	Water in a basin		ml litre
Insect		mg g kg	Water tank		ml litre
Chicken		mg g kg	Scientific chemicals		ml litre

2. The mass of 1 litre of water = 1 kg. Complete the following:

- a. 2 litre of water = kg.
- b. 500 ml of water = kg.
- c. 250 ml of water = kg.
- d. 125 ml of water = kg.
- e. 50 ml of water = kg.
- f. 2 300 ml of water = kg.
- g. 1,5 litre of water = kg.
- h. 4,55 litre of water = kg.

3. Complete the table below and answer the questions.



Petrol



Milk



Cooking oil



Paraffin



Sea Water



Mercury

Liquid (1 litre)	Weight	
	Kg	g
Water		
Sea water		
Milk		
Paraffin		
Petrol		
Cooking oil		
Mercury		



Water

- a. Which liquid is the lightest?
- b. Which liquid is the heaviest?
- c. Why do the mass of these liquids differ?



Mercury is so heavy!!!

Some thinking fun ...



- With an unlimited supply of water and only two unmarked containers with a capacity of exactly 9 litres and 4 litres.
- How can you measure out exactly 6 litres of water into one or both of these containers?
- What will happen if the task spoke of 9 kg, 4 kg and 6 kg of water instead of litres? Would your answer be the same or different? Why?

Revise: go through this summary on solving a problem using the questions as a guide

i. Read and underline the question. What are you looking for in this problem?	ii. Write down the numbers and hidden numbers. Note that sometimes the numbers are written in words.	iii. Write down the key word/s. What basic operation (+, -, x or ÷) will you use?
iv. Cross out the numbers you don't need. What information is not needed in solving this problem?	v. Solve by using pictures, drawings or concrete apparatus. Draw a picture to help you to solve the problem.	vi. Write a number sentence. What numbers and basic operation(s) will you use?
vii. Show all your work. Why did you choose this response?	viii. Does your answer make sense? Try it out. After getting an answer, how can I check to see if it is correct?	

1. Do the following problems in your writing books.

a. A 500 g bag of flour costs R3,50. How much will 1,5 kg cost?



Possible solution:

- How much will 1,5 kg cost?
- The key numbers are 500 g, R3,50 and 1,5 kg.
- Addition or multiplication and division
- You will need all the numbers in this word problem.
-



R3,50



R3,50



R3,50

vi. $R3,50 + R3,50 + R3,50 =$

OR $1\ 500\text{ g} \div 500\text{ g} = 3$; $3 \times R3,50 =$

vii. $R9 + R1,50 = R10,50$

viii. $R10,50 \div 3 = R3,50$

- b. My mother uses 7,45 kg of rice out of a 10 kg bag. How much is left?

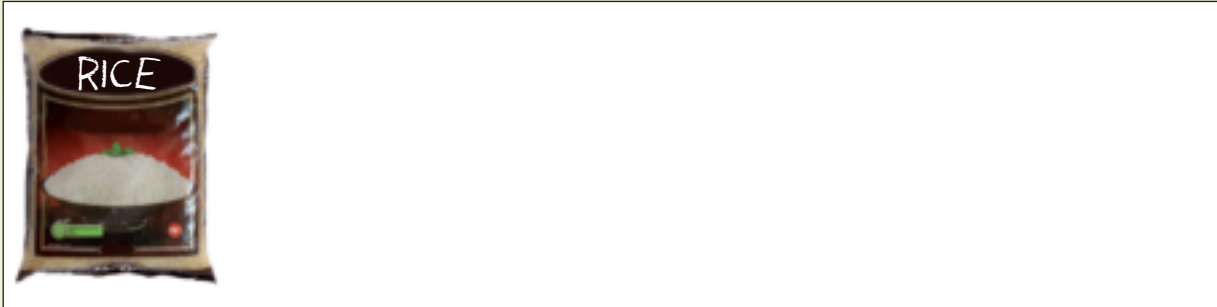

- c. My brother has a mass of 25 kg and my sister is double that. What is my sister's mass?

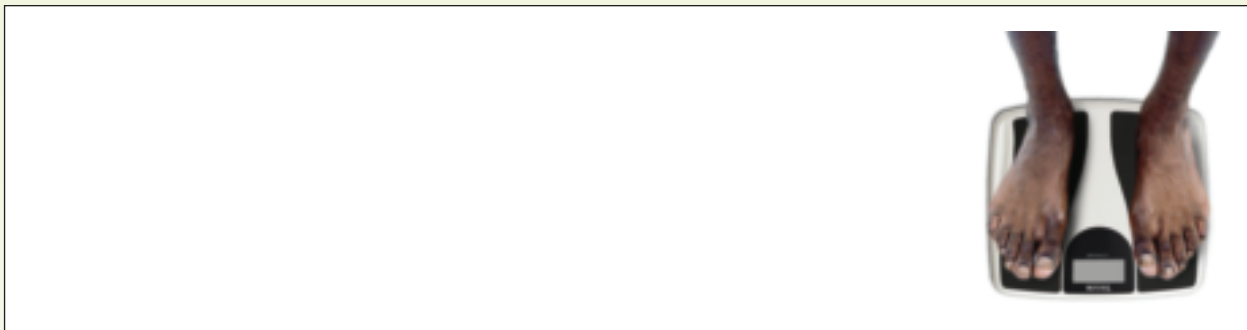

- d. If one cake needs 275 g of self-raising flour, how much flour will I need to make three cakes?

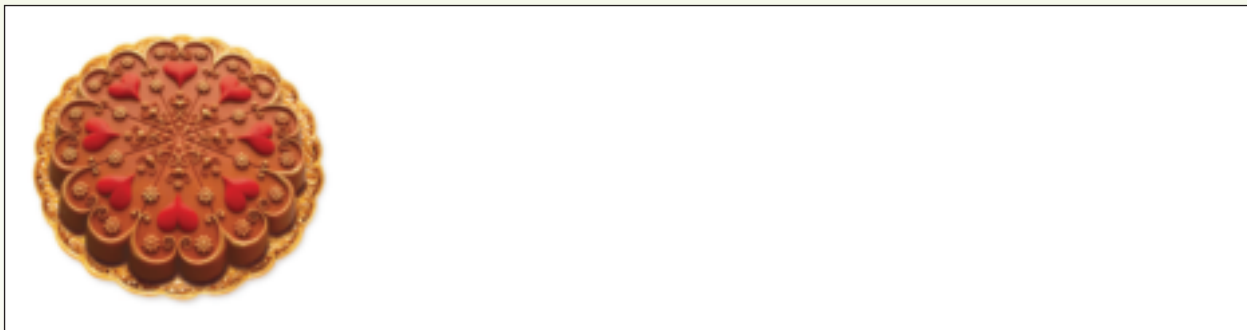

- e. A shop sells 40 kg of rice for R450. How much does 1 kg cost?



continued

Sign:

Date:

- f. Ken's family uses 3,5 kg of rice a week. How much rice does his mother buy a week?



- g. When my mother buys washing powder she pays R45,65 for a 3 kg bag. How much does she pay for 1 kg?



- h. My father eats 125 g of chocolate a day. How many grams will he eat in two weeks?



- i. I was given a 4 kg bag of rice to take to my grandmother's house. On the way there the bag tore and a quarter of it spilled out. How many kilograms of rice will my grandmother have to cook?



- j. A chocolate cake needs 445 g of flour. If my aunt wants to bake 20 cakes, how much flour will she need?



- k. A school book weighs 25 g and I have 12 books in a bag. How much do the books weigh?

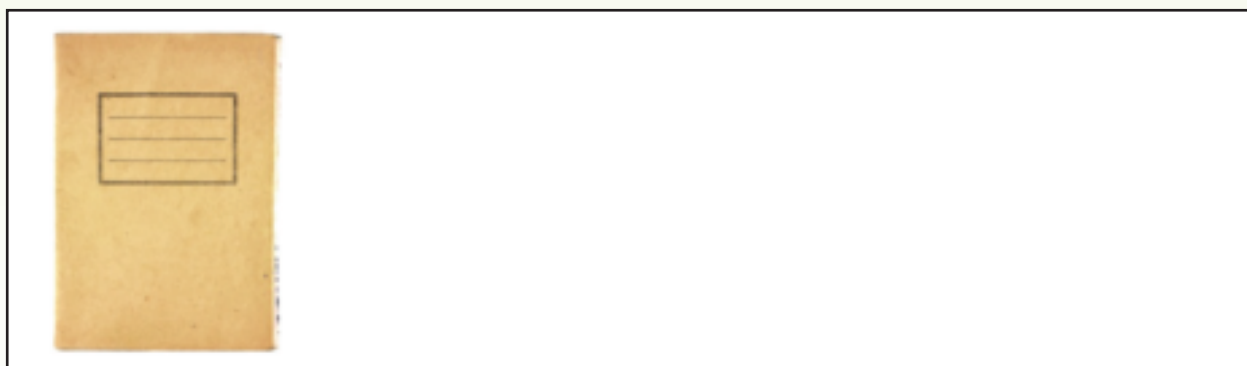

Sign: _____
Date: _____

People sometimes speak of a half a million. What does that mean?

1. State whether the following is true or false:

- a. The South African population grows by more than 500 000 in a year.
- b. There are 12 500 000 people living in Gauteng.
- c. The South African government plans to upgrade 500 000 shacks by 2014.
- d. In the first 10 days of the World Cup in 2010 some 500 000 tickets were sold.
- e. In an average South African school we will find 500 children.

2. Complete the following:

- a. $500 + 40 + 300\,000 + 5\,000 + 90\,000 + 1 =$
- b. $6 + 900 + 9\,000 + 70 + 10\,000 + 400\,000 =$
- c. $80 + 6 + 500 + 6\,000 + 400\,000 + 20\,000 =$
- d. $400\,000 + 20\,000 + 5\,000 + 8 =$
- e. $300\,000 + 400 + 20 =$



3. Change the digit 5 to zero in each number. Show the operation that will make it zero.

- a. $478\,578 =$
- b. $353\,897 =$
- c. $294\,025 =$
- d. $500\,000 =$
- e. $893\,257 =$

4. Your uncle won R12 million in the lotto. He went to purchase items at different stores. Help him to fill in his cheques. Guess what he purchased with these cheques.

Rich People's Bank **● R299 999**

Pay _____
the sum of _____ R _____

Check No. Branch Sort Code Account No.
#000243 # 01-0203 01234567#

Rich People's Bank **● R345 236**

Pay _____
the sum of _____ R _____

Check No. Branch Sort Code Account No.
#000243 # 01-0203 01234567#

Rich People's Bank **● R105 520**

Pay _____
the sum of _____ R _____

Check No. Branch Sort Code Account No.
#000243 # 01-0203 01234567#

5. Write in expanded notation. Use the digits 1 to 9 to make five different 9-digit numbers smaller than 500 000 000 but bigger than 200 000 000.

- a.
- b.
- c.
- d.
- e.



Sign:

Date:

continued

6. What do ascending and descending order mean?

7. Write the following in ascending order.

a. 22 256 276, 22 256 672, 22 256 267, 22 256 627

b. 73 782 894, 73 782 498, 73 782 849, 73 782 489

c. 83 243 228, 83 242 283, 83 243 822, 83 243 282

d. 44 219 248, 44 219 284, 44 219 842, 44 219 824

e. 63 318 278, 63 318 827, 63 318 872, 63 318 287

f. 63 318 278, 63 318 827, 63 318 872, 63 318 287

8. Write the following in descending order.

a. 11 271 872, 11 271 278, 11 172 827, 11 721 782

b. 92 287 198, 92 782 891, 92 278 189, 92 891 782

c. 74 357 543, 74 753 345, 74 375 543, 74 357 534

d. 53 573 798, 53 375 897, 53 537 798, 53 573 789

e. 32 122 678, 32 221 876, 32 122 687, 32 212 678

f. 91 847 324, 91 748 423, 91 874 324, 91 847 342

9. Compare the underlined digits, and explain the relationship that you see in your own words.

a. 3 563 and 1 635

b. 2 002 and 2 002

c. 999 and 9 999

d. 1 and 1 001

e. 4 000 and 44

10. Look at the numbers board and answer the questions?

1	2	3	4	5	6	7	8	9	10
11	12	13	14	15	16	17	18	19	20
21	22	23	24	25	26	27	28	29	30
31	32	33	34	35	36	37	38	39	40
41	42	43	44	45	46	47	48	49	50
51	52	53	54	55	56	57	58	59	60
61	62	63	64	65	66	67	68	69	70
71	72	73	74	75	76	77	78	79	80
81	82	83	84	85	86	87	88	89	90
91	92	93	94	95	96	97	98	99	100

a. Colour all the prime numbers.

b. What is a prime number?

c. What is a composite number?

Number puzzle

My father remembers seeing a beautiful house for sale. It was a beautiful place. He couldn't remember the price of the house, but he knew it was a 6 digit number.

- He remembered that the first digit was a 5 and the ten thousand's place was a 7.
- He remembered seeing a number 1.
- In the hundred's place he remembered the number was 3 times the number in the thousand's place.
- He said the number in the one's place was 4 times the number in the ten's place.
- Finally he said the number 2 was in the thousand's place.
- What is the number?



Sign:

Date:

What would you rather say?



My mother is going to purchase a house for **R498 789**

My mother is going to purchase a house for **R500 000**.



My brother is going to buy a car for **R201 987**.

My brother is going to buy a car for **R200 000**



The truck transported **334 579** tomatoes

The truck transported **300 000** tomatoes.

1. Round off to the nearest 10. Circle the digit which you look at when deciding whether to round up or down to the nearest 10. Complete the sentences.

- a. 345 882 is between and and would be rounded to .
- b. 278 947 is between and and rounded to .
- c. 2 489 371 is between and and rounded to .
- d. 15 218 965 is between and and rounded to .
- e. 593 499 999 is between and and rounded to .

2. Round off to the nearest 100. Circle the digit which you look at when deciding whether to round up or down to the nearest 100. Complete the sentences.

- a. 345 882 is between and and would be rounded to .
- b. 278 947 is between and and rounded to .
- c. 3 489 371 is between and and rounded to .
- d. 87 218 965 is between and and rounded to .
- e. 357 499 999 is between and and rounded to .

3. Round off to the nearest 1 000. Circle the digit which you look at when deciding whether to round up or down to the nearest 1000. Complete the sentences.

- a. 345 882 is between and and would be rounded to .
- b. 278 947 is between and and rounded to .
- c. 4 489 371 is between and and rounded to .
- d. 60 218 965 is between and and rounded to .
- e. 300 499 999 is between and and rounded to .

To estimate the cost of 11 pens at 95c each, you round down 11 to 10 pens and round up 95c to R1.

The estimated cost would then be $10 \times R1 = R10,00$

4. Complete the questions below:

a. Estimate the cost of 27 sweets at 81c each?

b. Estimate the cost of 41 chocolate at R5,40 each?

c. Estimate the cost of 199 cool drinks at R6,90 each?

d. Estimate the cost of 1 002 packets of chips at R4,10 each?

e. Estimate the cost of 19 542 lollipops at R1,99 each?

5. The first number below was rounded off to the second number. Was it rounded off to the nearest 5, 10, 100 or 1 000? (The answer could be more than one of the options.)

a. R83 was rounded off to R100.

b. R1 836 was rounded off to R1 840.

c. R104 was rounded off to R0.

d. R5 790 was rounded off to R6 000.

e. R5 080 was rounded off to R5 100.

f. R5 049 was rounded off to R5 050.

Help a friend

Create a picture which explains to a small child the concept of "rounding off". (For example, if you are walking from ... to ..., and it starts to rain, which place of shelter is closer?)

Remember to show very carefully the point at which you start rounding off in the opposite direction.



Sign:

Date:

71a

Addition problems with up to 5-digit numbers

How fast can you answer this?

- **Add** 40 000 + 3 000 + 200 + 30 + 2 + 1.
- What is the **sum** of 2 300 and 6 500?
- How many are 250 and 4 000 **altogether**?
- What three numbers have a **total** of 250?
- **Add** 190 and 45.
- What is the **sum** of 2 000 and 456?
- How many are 375 and 15 **altogether**?
- Which three numbers have a **total** of 1 000?

How did the blue words help you?



1. Solve the following problems. The pictures may guide you. Also use the blue word.

- a. At a school concert, 363 adults **and** 655 children were seated in a hall.
How many chairs were needed altogether?

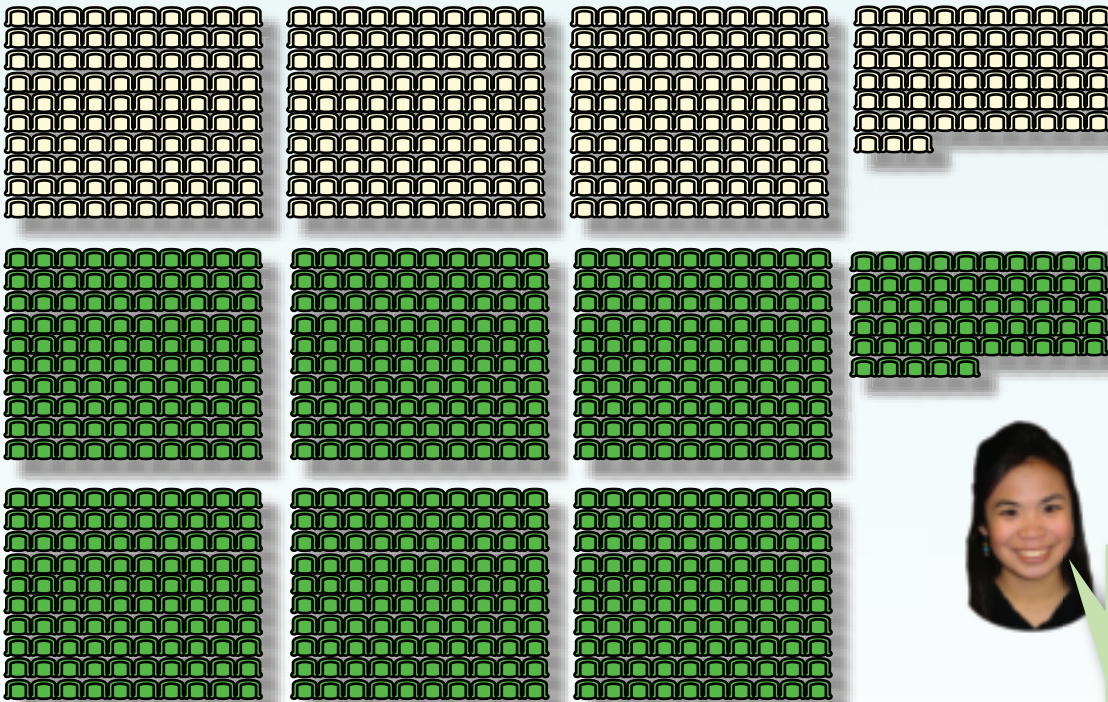

What word will help me to choose the operation?

and

+



Try to form a picture in your mind. These are the number of seats.

$$300 + 600 + \underline{\quad\quad} + 50 + \underline{\quad\quad} + 5$$

=
=
=
=

Term 3

b. There were 4 876 spectators at the Pirates soccer match and 6 973 spectators at the Chiefs soccer match. How many people watched these soccer matches?

i. What picture do you see in your mind?

Handwriting practice area with horizontal lines for the answer to question i.

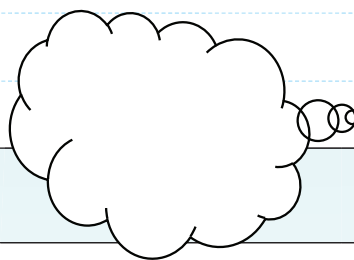

ii. What operation should you use?

Handwriting practice area with horizontal lines for the answer to question ii.

iii. Solve the problem.

Handwriting practice area with horizontal lines for the answer to question iii.

Sign: _____
Date: _____

continued →

71b

Addition problems with up to 5-digit numbers continued

c. A farmer planted 5 389 trees in a new plantation. The old plantation has 3 893 trees. How many trees are there altogether?

Blank lined area for writing the solution to problem c.

Term 3

2. Look at the pictures below and write an interesting addition word problem.

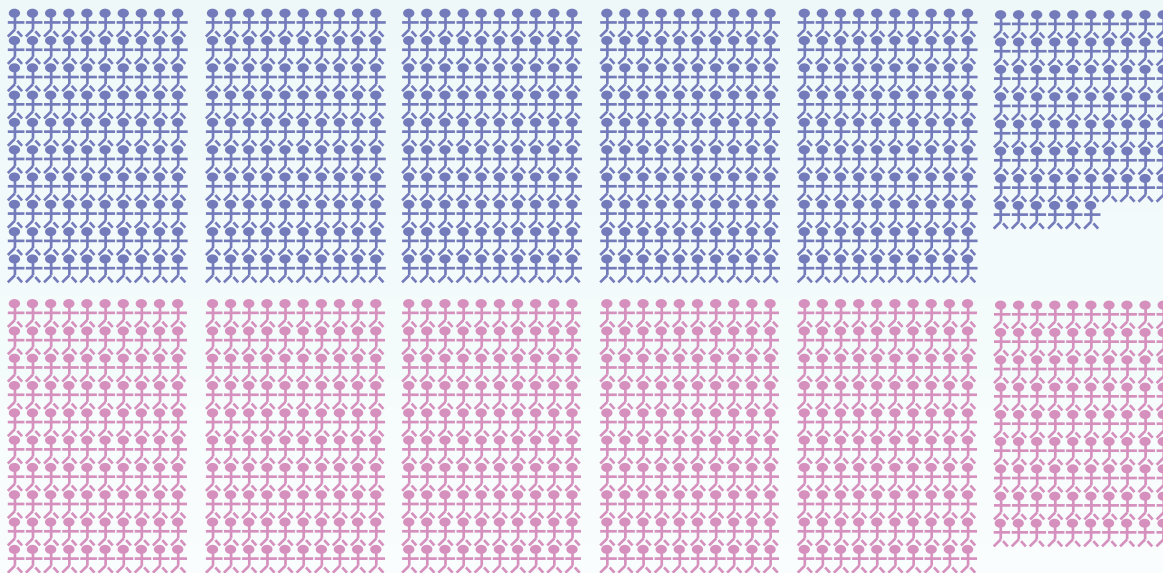

Blank lined area for writing an addition word problem based on the tree icons.

3. Write an appropriate and interesting word problem for: 37 802 and 65 321.
Solve it.

A large rectangular area with horizontal dashed lines for writing a word problem and its solution.

Operation "Snap"

What do you need:

Cut-out 6.

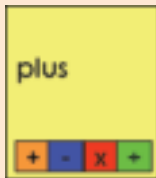

What to do:

Step 1: Deal out an equal number of cards to each player.

Step 2: Each player puts their stack of cards face down in front of them.

Step 3: Players all turn one card face up and place it next to their face down stack.

Step 4: Players look at each others cards to see if any of the cards have words with same meaning).

- If yes, someone says "Snap."
- The first person to say "Snap" gets all the cards in the face-up stacks that match each other. Play then continues from Step 3.
- If no, play continue from Step 3.
- If a player gets to the end of the face-down stack before the end of the game, he or she turns the face up stack over again and continues.
- The winner is the player with the most cards.



Sign: _____
Date: _____

Subtraction problems with up 5-digit numbers

How fast can you answer this?

- **Subtract** 40 000 **from** 80 000.
- What is the **difference between** 7 800 and 5 400?
- **Minus** 90 000 and 55.
- **Decrease** 100 000 **by** 10 000.
- **Subtract** 19 000 **and** 450.
- **Reduce** 50 000 with 1 000.
- **Take** 15 000 **from** 45 000.
- **Take away** 25 000 **from** 100 000.

How did the blue words help you?



1. Solve the following problems. The pictures may guide you. Also use the blue word.

- a. At the school concert, 1 018 people attended.
363 are adults. How many seats are **left** over for the children?

What word will help me to choose the operation?

left

-

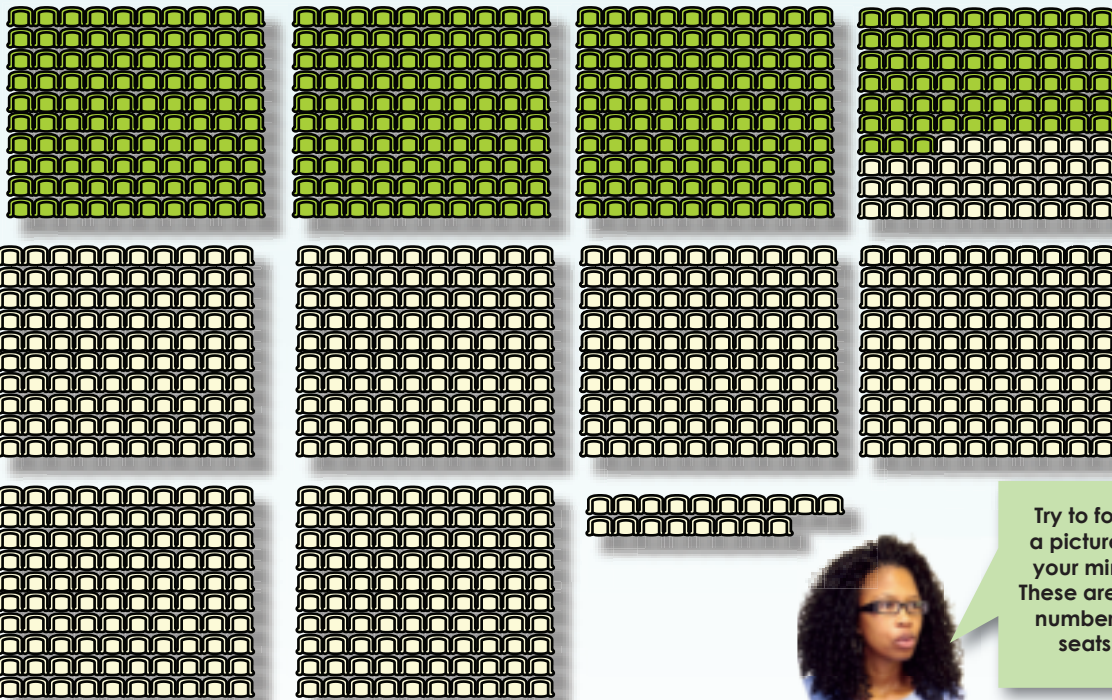

$$1\ 018 - 363$$

Try to form a picture in your mind. These are the number of seats.



b. There are 34 763 trees in a plantation. In a storm 14 999 trees fell.
How many trees are still standing?

i. What picture do you see?

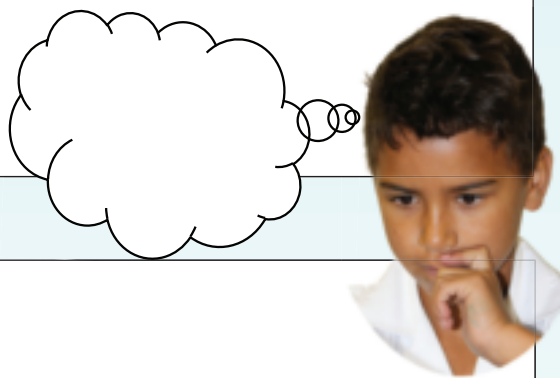
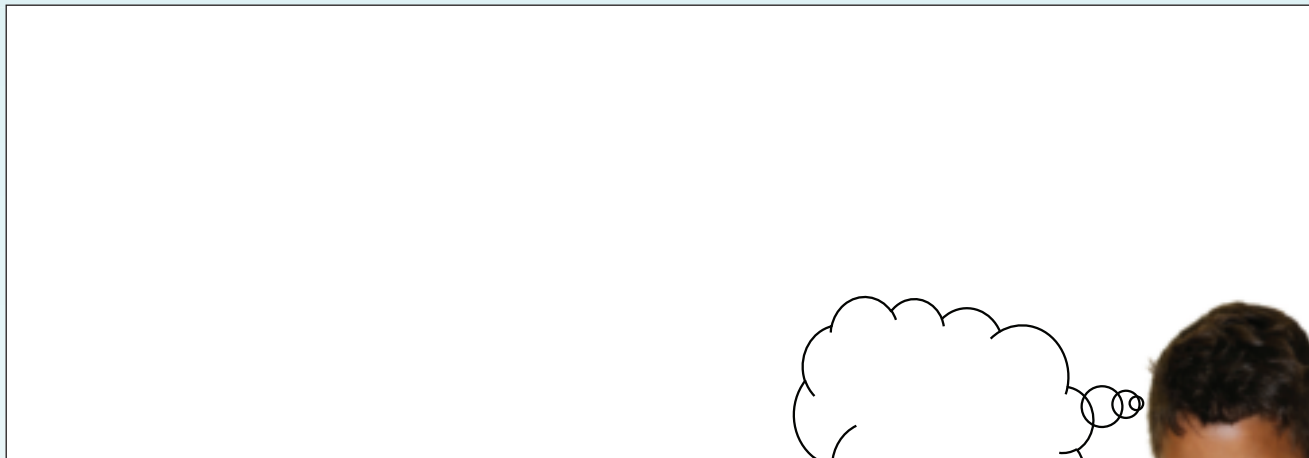

ii. What operation should you use?



iii. Solve the problem.



Sign:

Date:

continued →

72b

Subtraction problems with up to 5-digit numbers continued

- c. There 24 789 people traveling in taxis? 17 989 people get off after 30 minutes. How many people are still in taxis?

Term 3

2. Look at the pictures below and write an interesting subtraction word problem.

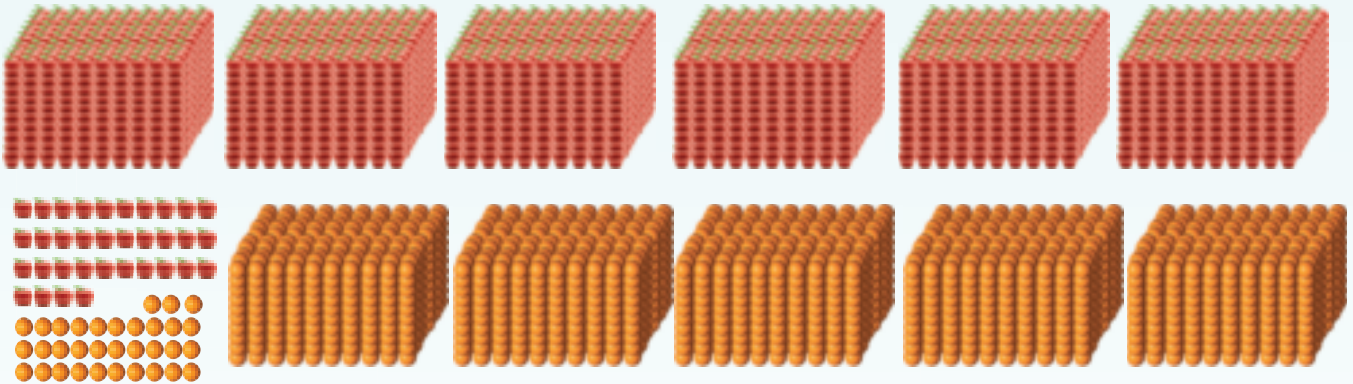

3. Write an appropriate and interesting word problem for: 99 999 and 38 238.
Solve it.

Play Operation "Snap"

What do you need:

Cut-out 6.

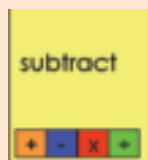
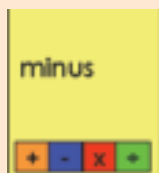

What to do:

Step 1: Deal out an equal number of cards to each player.

Step 2: Each player puts their stack of cards face down in front of them.

Step 3: Players all turn one card face up and place it next to their face down stack.

Step 4: Players look at each others cards to see if any of the cards have words with same meaning).

- If yes, someone says "Snap."
- The first person to say "Snap" gets all the cards in the face-up stacks that match each other. Play then continues from Step 3.
- If no, play continue from Step 3.
- If a player gets to the end of the face-down stack before the end of the game, he or she turns the face up stack over again and continues.
- The winner is the player with the most cards.





Sign: _____

Date: _____





Talk about money. Look at the picture and make your own story.































































1. Give five different combinations of these money notes. Your combinations should be in rands or cents.

a.		R5 + R5				
b.						
c.						
d.						
e.						

2. How much does it cost? Gina wants to buy some clothes and accessories. She visits various shops on different days. Every time she looks at her purse. Does she have enough money?

Money available	Cost	Need more money?	How much do I still need?	Will get change?	How much change will I get?
	Shop 1: R79,95 for jeans				
	Shop 2: R99,95 for a jersey				
	Shop 3: R65,75 for shoes				
	Shop 4: R39,95 for a bag				
	Shop 5: R55 for cellphone airtime				

3. I kept record of my money matters last year. Please help me, I lost some information.

Month	Pocket Money	Expenditure	Savings 
January			
February			
March	 	 	
April	 		 
May	 	 	
June	 	 	
July	 	 	
August	 		   
September	 	   	
October	 	  	
November	 		      
December	 	     	
Total:			

a. What was the total amount of money you received in one year?

b. What was your total **expenditure** for the year?

c. What was your total **savings** for the year?

Sign:

Date:

Read the comic strip, and tell what you think Palesa will do next?

Panel 1: Palesa: Mom, I want to start save money. Mom: That is great my child.

Panel 2: Palesa: Where should I start? Mom: You first need to know how much you get each month.

Panel 3: Palesa: ... and know how much I spend. Mom: Excellent! What do you think you should do next?

Panel 4: Palesa: Hmmm!!! I think I should minus what I spend from what I get. Mom: Great, you must have a great teacher teaching you this.

1. Help me to calculate my savings for the month using the table below. The till slips may help you.

Fishy Fast Foods
Tel: (011) 907 0803
Vat 437823468973
Date: 3 March 2011
Chips R15,99
Fish R19,99
15 % VAT R 5,04
TOTAL: R41,02

Cool Clothing
Tel: (011) 907 0804
Vat 437839487293
Date: 15 March 2011
Socks: R12,99
15 % VAT R 1,82
TOTAL: R14,81

Ring-ring Cells
Tel: (011) 907 0805
Vat 437838972934
Date: 20 March 2011
Airtime: R29,00

Shoe-shoe Shops
Tel: (011) 907 0804
Vat 4378330948092834
Date: 22 March 2011
Airtime: R105,99
14% VAT R 15,84
TOTAL: R120,83

Income		Expenditure		Savings
Pocket money:	R150,00	Charity:	R50,00	
Birthday money:	R120,75			
Washing and polishing Dad's car:	R25,00			
Totals				

Term 3

2. Do the following money problems.

a. My pocket money is R75 per month. I spend the following: R15,00 at the school tuck shop. R14,75 for a new pair of socks, R25 for a movie ticket. I also gave R12,50 to charity. Complete the table below.

Income		Expenditure		Savings
Totals				

a. Look at the information in the table below. Write down your own word problem.

Income		Expenditure		Savings
	350	Airtime:	R29	
		Tuck shop money:	R52,50	
		Charity:	R75,75	
		Jeans:	R95,99	
		Movie ticket:	R25	
Totals				

Use the following words/phrases to create a picture:

Cost Savings
 Money makes the world go round.
 Income

Sign:

Date:

What is the difference between the numbers.

10 000	20 000	30 000	40 000	50 000	60 000	70 000	80 000	90 000	100 000
10 005	20 005	30 005	40 005	50 005	60 005	70 005	80 005	90 005	100 005
10 750	20 750	30 750	40 750	50 750	60 750	70 750	80 750	90 750	100 750
100 050	119 050	129 050	139 050	149 050	159 050	169 050	179 050	189 050	199 050
110 400	120 400	130 400	140 400	150 400	160 400	170 400	180 400	190 400	200 400

1. What number comes next?

a. 60 000, 70 000, 80 000, b. 72 500, 82 500, 92 500,

c. 149 999, 159 999, 169 999, d. 165 250, 175 250, 185 250,

2. Complete the table: Use the given number each time.

Number	Add 10	Add 100	Add 1 000	Add 10 000
187 563	18573			
143 784				
127 899				
136 999				
189 999				

Examples:

Example 1:

$$135\,689 + 42\,999$$

$$= 100\,000 + 30\,000 + 40\,000 + 5\,000 + 2\,000 + 600 + 900 + 80 + 90 + 9 + 9$$

$$= 100\,000 + 70\,000 + 7\,000 + 1\,500 + 170 + 18$$

$$= 100\,000 + 70\,000 + 7\,000 + 1\,000 + 500 + 100 + 70 + 10 + 8$$

$$= 100\,000 + 70\,000 + 8\,000 + 600 + 80 + 8$$

$$= 178\,688$$

Example 2:

$$\begin{array}{r} 1\ 3\ 5\ 6\ 8\ 9 \\ +\ 4\ 2\ 9\ 9\ 9 \\ \hline 1\ 8 \\ 1\ 7\ 0 \\ 1\ 5\ 0\ 0 \\ 7\ 0\ 0\ 0 \\ 7\ 0\ 0\ 0\ 0 \\ 1\ 0\ 0\ 0\ 0\ 0 \\ \hline 1\ 7\ 8\ 6\ 8\ 8 \end{array}$$

$$\begin{array}{l} (9 + 9) \\ (80 + 90) \\ (600 + 900) \\ (5\ 000 + 2\ 000) \\ (30\ 000 + 40\ 000) \\ (100\ 000 + 0) \end{array}$$

Example 3:

$$\begin{array}{r} 1\ 1\ 1 \\ 1\ 3\ 5\ 6\ 8\ 9 \\ +\ 4\ 2\ 9\ 9\ 9 \\ \hline 1\ 7\ 8\ 6\ 8\ 8 \end{array}$$

3. Use any two methods to calculate the following. Write the steps down.

a. $145\ 345 + 32\ 453 =$

b. $137\ 876 + 52\ 128 =$

c. $163\ 762 + 25\ 289 =$

d. $152\ 784 + 35\ 568 =$

e. $172\ 689 + 29\ 999 =$

f. $99\ 999 + 99\ 999 =$

4. Test your answers to questions 3 a to f using the inverse operation of addition. Use a separate piece of paper.

continued 



Sign: _____

Date: _____

5. Solve the following word problems.

- a. The chicken farmer delivered 29 500 eggs on Monday and 32 700 on Tuesday. How many eggs are there in total?

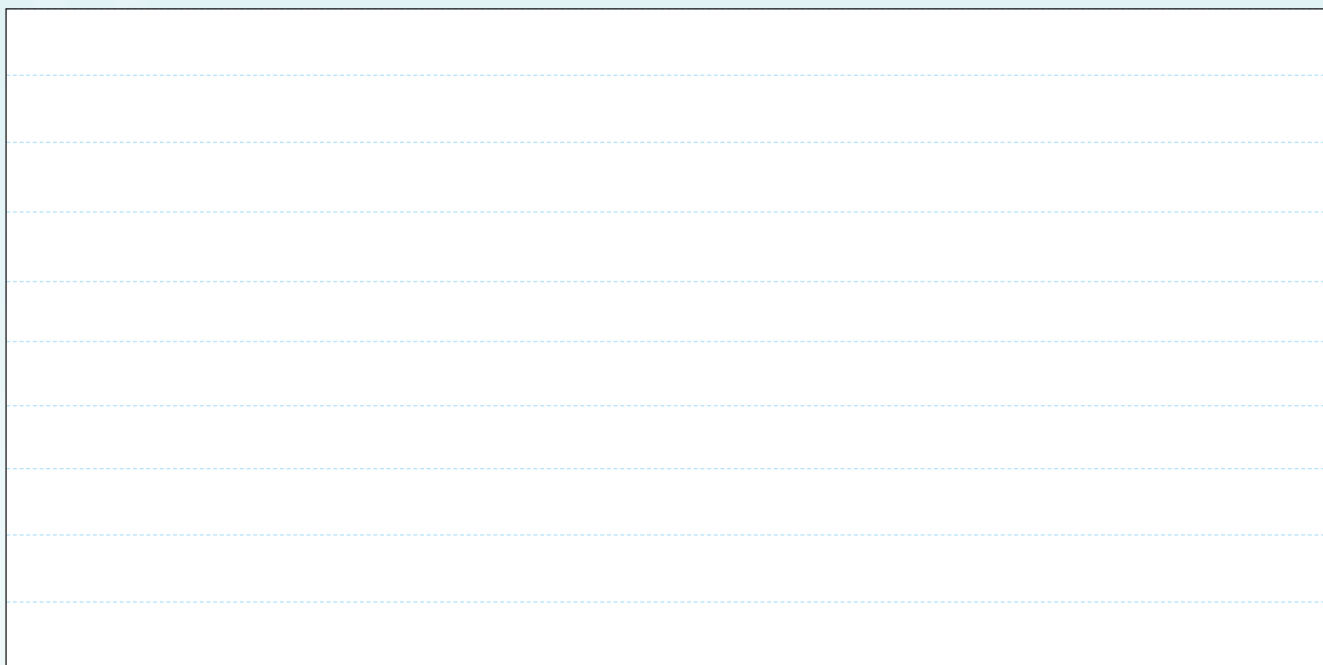

- b. We walked 120 000 mm from point A to B. We walked another 350 000 mm from point B to C. How far did we walk. Give your answer in mm and m. Which is more appropriate to use m or mm?

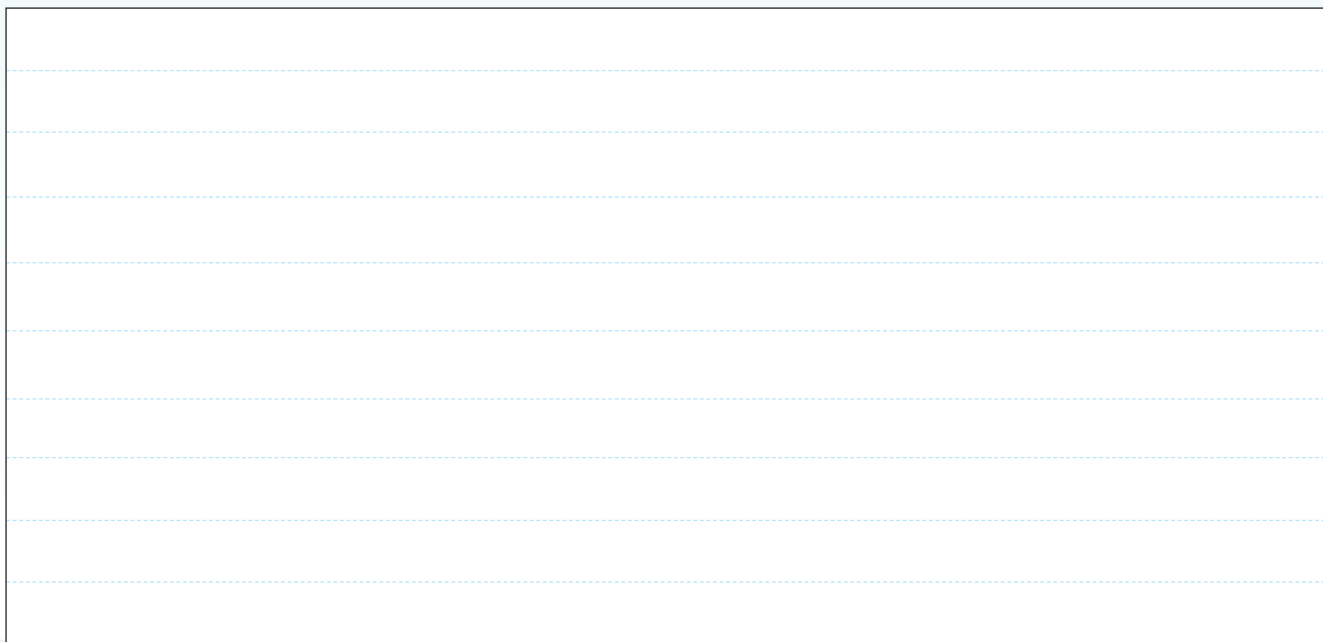

6. Write an appropriate and interesting word sum for:
150 000 and 30 000. Solve it.

A large rectangular area with horizontal dashed lines for writing a word sum and its solution.



What is the size of your number:

What do you need:

- Use the 1 000s, and 10 000s and 100 000s dice. (Cut out 3)
- Piece of paper.

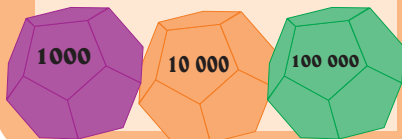

What to do:

- Roll the 1 000s die.
- Add the number landed on to the first number on the blue card. Write your sum on a piece of paper.
- Do the same with the next four numbers.
- Repeat the activity with the 10 000s and 100 000s dice.
- Learners check each others sums.
- The winner is the person with the most correct answers

45 999
32 372
65 392
99 999
76 690



Sign:

Date:

What is the difference between the numbers.

10 000	20 000	30 000	40 000	50 000	60 000	70 000	80 000	90 000	100 000
10 009	20 009	30 005	40 009	50 009	60 009	70 009	80 009	90 009	100 009
10 055	20 055	30 055	40 055	50 055	60 055	70 055	80 055	90 055	100 055
10 065	20 065	30 065	40 065	50 065	60 065	70 065	80 065	90 065	100 065
110 400	120 400	130 400	140 400	150 400	160 400	170 400	180 400	190 400	200 400

1. What number comes next?

a. 187 500, 177 500, 167 500,

b. 135 250, 125 250, 115 250,

c. 152 999, 142 999, 132 999,

d. 143 654, 133 654, 123 654,

2. Complete the table: use the given numbers:

Number	Subtract 10	Subtract 100	Subtract 1 000	Subtract 10 000
164 389	164 289			
158 304				
187 643				
199 999				
109 000				

Examples:

Example 1:

$$185\,743 - 59\,857$$

$$= 100\,000 + (80\,000 - 50\,000) + (5\,000 - 9\,000) + (700 - 800) + (40 - 50) + (3-7)$$

$$= 100\,000 + 30\,000 + (5\,000 - 9\,000) + (700 - 800) + (30 - 50) + (13-7)$$

$$= 100\,000 + 30\,000 + (5\,000 - 9\,000) + (600 - 800) + (130 - 50) + (13-7)$$

$$= 100\,000 + 30\,000 + (4\,000 - 9\,000) + (1\,600 - 800) + (130 - 50) + (13-7)$$

$$= 100\,000 + 20\,000 + (14\,000 - 9\,000) + (1\,600 - 800) + (130 - 50) + (13-7)$$

$$= 100\,000 + 20\,000 + 5\,000 + 800 + 80 + 6$$

$$= 125\,886$$

Example 2:

$$\begin{array}{r} 1\ 8\ 5\ 7\ 4\ 3 \\ -\ 5\ 9\ 8\ 5\ 7 \\ \hline 6 \\ 8\ 0 \\ 8\ 0\ 0 \\ 5\ 0\ 0\ 0 \\ 2\ 0\ 0\ 0\ 0 \\ +\ 1\ 0\ 0\ 0\ 0\ 0 \\ \hline 1\ 2\ 5\ 8\ 8\ 6 \end{array}$$

$$\begin{array}{l} (13 - 7) \\ (130 - 50) \\ (1\ 600 - 800) \\ (14\ 000 - 9\ 000) \\ (70\ 000 - 50\ 000) \\ (100\ 000 - 0) \end{array}$$

Example 3:

$$\begin{array}{r} 7\ 14\ 16\ 13\ 10 \\ 1\ \cancel{8}\ \cancel{5}\ \cancel{7}\ \cancel{3} \\ -\ 5\ 9\ 8\ 5\ 7 \\ \hline 1\ 2\ 5\ 8\ 8\ 6 \end{array}$$

3. Use both methods to solve the sums:

a. $188\ 763 - 56\ 541 =$

b. $175\ 754 - 44\ 639 =$

Handwriting practice area for problem a and b, featuring horizontal dashed lines for alignment.

Continue on an extra sheet of paper

c. $169\ 657 - 53\ 489 =$

d. $163\ 864 - 48\ 986 =$

Handwriting practice area for problem c and d, featuring horizontal dashed lines for alignment.

Continue on an extra sheet of paper

e. $157\ 802 - 99\ 999 =$

f. What method do you prefer? Why?

Handwriting practice area for problem e and f, featuring horizontal dashed lines for alignment.

Continue on an extra sheet of paper

Sign:

Date:

continued

4. Solve the following word problems:

- a. There are 190 500 tomatoes coming from a tomato farm. 47 925 were rotten. How many tomatoes can we send to the market?

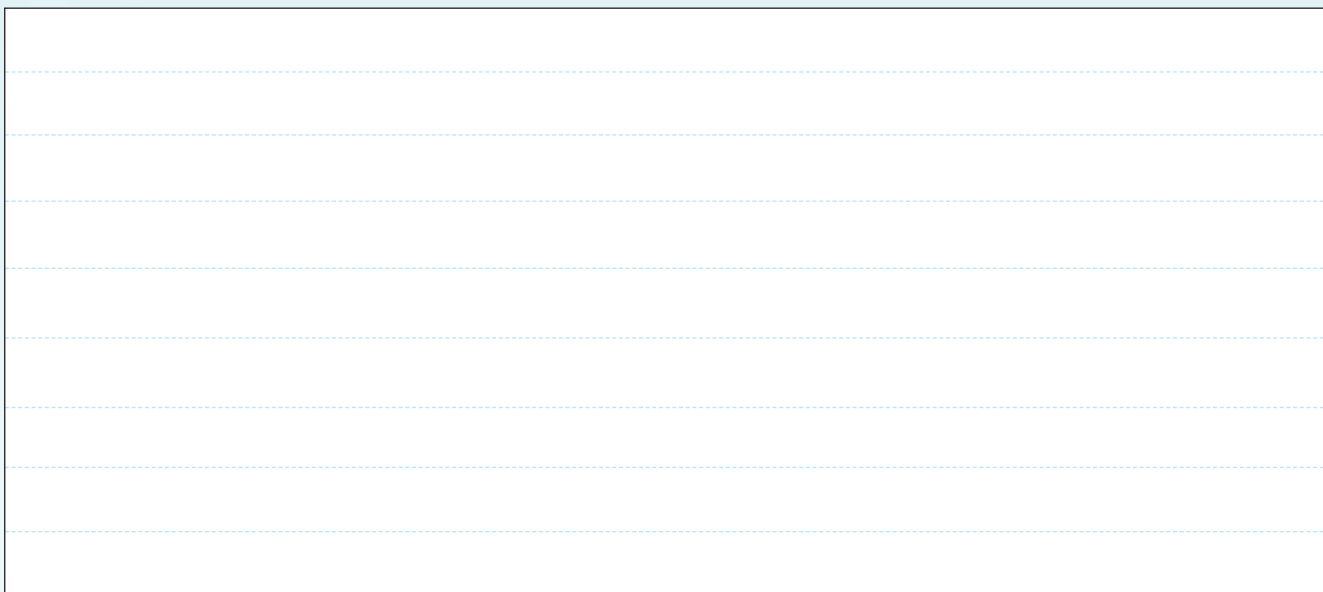

- b. Children in our grade drank 145 000 ml of water. The grade fives drank 28 500 ml less than us. How much did they drink? Write your answer in ml and litres. Which measurement is more appropriate to use?

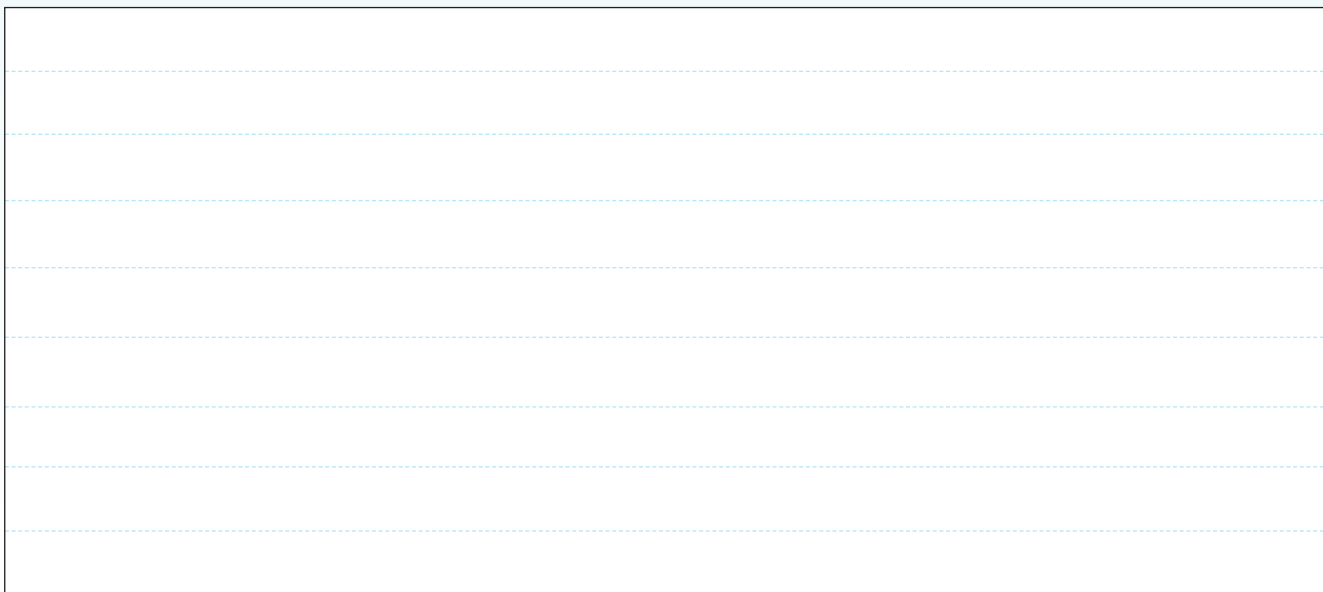
**5. Use a calculator to check your answers in question 4.**

6. Write an appropriate and interesting subtraction word sum for: 190 000 and 35 000. Solve it.

A large rectangular area with horizontal dashed lines for writing a subtraction word sum and its solution.

—

What is the size of your number:

What do you need:

- Use the 1 000s and 10 000s dice.
- Piece of paper.



What to do:

- Roll the 1 000s die.
- Subtract the number landed on, to the first number on the blue card. Write your sum on a piece of paper.
- Do the same for the next four numbers.
- Repeat the activity with the 10 000s dice.
- Learners check each others sums.
- The winner is the person with the most correct answers

189 382
135 201
199 000
147 542
190 005

Sign:

Date:

What is the difference between the numbers in each of these rows?

100 000	200 000	300 000	400 000	500 000
91 000	101 000	201 000	301 000	401 000
70 500	80 500	90 500	100 500	110 500
89 999	99 999	109 999	119 999	129 999
187 663	287 663	387 663	487 663	587 663

What is the difference between the numbers? Count backwards.

1. What number comes next?

a. 100 000, 200 000, 300 000,

b. 172 500, 272 500, 372 500,

c. 199 999, 299 999, 399 999,

d. 283 321, 293 321, 303 321,

2. Complete the table:

Number	Add 10 000	Subtract 10 000	Add 100 000	Subtract 100 000
223 340				
367 245				
378 392				
263 287				
399 999				

Examples

Example 1:

$$\begin{aligned}
 &278\,467 + 197\,539 \\
 &= 200\,000 + 100\,000 + 70\,000 + 90\,000 + 8\,000 + 7\,000 + 400 + 500 + 60 + 30 + 7 + 9 \\
 &= 300\,000 + 160\,000 + 15\,000 + 900 + 90 + 16 \\
 &= 300\,000 + 100\,000 + 60\,000 + 10\,000 + 5\,000 + 900 + 90 + 10 + 6 \\
 &= 400\,000 + 70\,000 + 5\,000 + 900 + 100 + 6 \\
 &= 400\,000 + 70\,000 + 5\,000 + 1\,000 + 6 \\
 &= 400\,000 + 70\,000 + 6\,000 + 6 \\
 &= 476\,006
 \end{aligned}$$

Example 2:

$ \begin{array}{r} 2\,7\,8\,4\,6\,7 \\ + 1\,9\,7\,5\,3\,9 \\ \hline 1\,6 \\ 9\,0 \\ 9\,0\,0 \\ 1\,5\,0\,0\,0 \\ 1\,6\,0\,0\,0\,0 \\ + 3\,0\,0\,0\,0\,0\,0 \\ \hline 4\,7\,6\,0\,0\,6 \end{array} $	$(7 + 9)$ $(60 + 30)$ $(400 + 500)$ $(8\,000 + 7\,000)$ $(70\,000 + 90\,000)$ $(200\,000 + 100\,000)$
--------------------------------------------------------------------------------------------------------------------------------------------------------------------------------------------------------------------------------------------------------------------------------------------------------------------------------	----------------------------------------------------------------------------------------------------------------------

Example 3:

$ \begin{array}{r} 1\,1\,1\,1\,1 \\ 2\,7\,8\,4\,6\,7 \\ + 1\,9\,7\,5\,3\,9 \\ \hline 4\,7\,6\,0\,0\,6 \end{array} $	
-----------------------------------------------------------------------------------------------------------------------------	--

Test your answer.

$ \begin{array}{r} 4\,7\,6\,0\,0\,6 \\ - 1\,9\,7\,5\,3\,9 \\ \hline 7 \\ 6\,0 \\ 4\,0\,0 \\ 8\,0\,0\,0 \\ 7\,0\,0\,0\,0 \\ + 2\,0\,0\,0\,0\,0\,0 \\ \hline 2\,7\,8\,4\,6\,7 \end{array} $	$(16 - 9)$ $(90 - 30)$ $(900 - 500)$ $(15\,000 - 7\,000)$ $(16\,000 - 9\,000)$ $(300\,000 - 100\,000)$
-----------------------------------------------------------------------------------------------------------------------------------------------------------------------------------------------------------------------------------------------------------------------------------------------------------------------	-----------------------------------------------------------------------------------------------------------------------

Test your answer.

$ \begin{array}{r} 9\,9\,9\,9 \\ 3\,10\,16\,10\,10 \\ \hline 4\,7\,6\,0\,0\,6 \\ - 1\,9\,7\,5\,3\,9 \\ \hline 2\,7\,8\,4\,6\,7 \end{array} $	
--------------------------------------------------------------------------------------------------------------------------------------------------------	--



Sign:

Date:

continued →

3. Use any two methods to calculate the following. Write down the steps.

a. $233\,432 + 124\,321 =$

b. $256\,782 + 243\,219 =$

Continue on an extra sheet of paper

c. $318\,764 + 271\,287 =$

d. $357\,573 + 122\,847 =$

Continue on an extra sheet of paper

e. $276\,894 + 228\,248 =$

f. $278\,872 + 199\,999 =$

Continue on an extra sheet of paper

4. Check your answers to Question 3. (Remember the inverse operation of addition is subtraction.) Show your checks.

Continue on an extra sheet of paper

5. Complete the following:

- a. You live in a street with 6 houses. Each family owns a car. The 1st family's car cost R100 000. The 2nd family's car cost R59 900 more. The 3rd family's car cost R25 000 less than the 2nd family's car. The 4th family paid a half a million rand for their car. The 5th family paid the same as the 1st family, and the last family paid R250 000 less than the 4th family.

How much did each of these families pay for their cars?

i. 2nd family

ii. 3rd family

iii. 4th family

iv. 5th family

v. 6th family



b. What is the value of the first and second family's cars?

c. Show your calculations for a. and b.

Continue on an extra sheet of paper

d. What is the value of the fourth and third family's cars?

e. What is the difference in price between the 4th and the 3rd family's cars?

I dropped my puzzle pieces ...

What to do:

I dropped my puzzle pieces. Help me to fill the spaces so that each row and column adds up to 30. You can only use each number once.

There are 144 ways to place the pieces

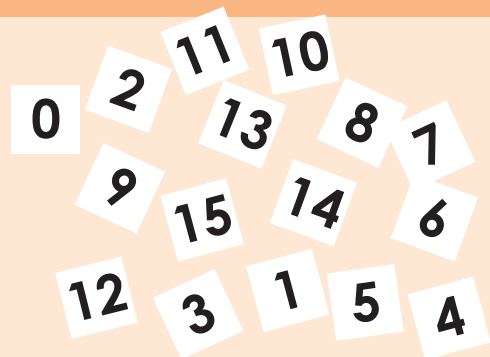

Sign:

Date:

What is the difference between the numbers? Count forwards.

600 000	700 000	800 000	900 000	1 000 000
500 010	600 010	700 010	800 010	900 010
507 000	607 000	707 000	807 000	907 000
590 000	690 000	790 000	890 000	990 000
546 999	556 999	566 999	576 999	586 999

What is the difference between the numbers? Count backwards.

1. What number comes next?

- a. 700 000, 800 000, 900 000,
- b. 683 500, 783 500, 883 500,
- c. 699 999, 799 999, 899 999,
- d. 577 382, 587 382, 597 382,

2. Complete the table:

Number	Add 10 000	Subtract 10 000	Add 100 000	Subtract 100 000
1 893 490				
1 473 894				
1 302 809				
1 200 008				
1 500 900				

3. First estimate and then calculate the answers to the following:

a. $784\,459 + 378 =$

b. $654\,458 + 9\,832 =$

(Handwriting practice area for questions a and b)

Continue on an extra sheet of paper

c. $689\,492 + 12\,599 =$

d. $529\,376 + 298\,743 =$

(Handwriting practice area for questions c and d)

Continue on an extra sheet of paper

What shape would we see from above if we turned each object shown here upside down?

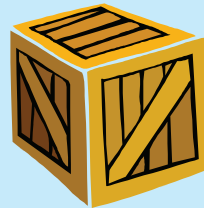

Words to remember:

top view
bottom view

side view

front view
back view

1. This person is looking at a car. Where is the person standing?



a.



b.



c.

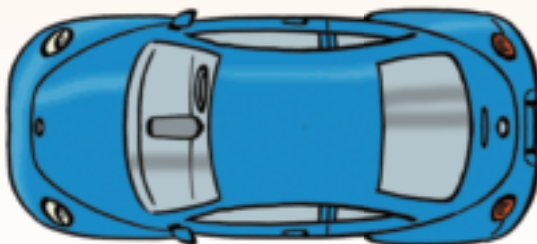

d.

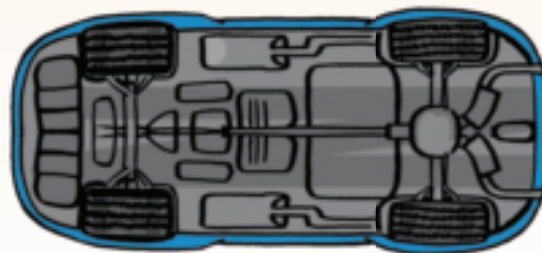

e.

2. Imagine a round cake.

a. If you look at the cake directly from above, what shape will you see?

b. If you look at the cake directly from the side?

c. If someone has cut a piece out of the cake, and you are looking at the side of the piece of cake, what shape will you see?

3. We often think of houses as looking like this:



a. Where would we be standing for the house to look like that?

b. Move to a different side of the house. What does it look like now (what shapes make up the picture we see now)?

Handwriting practice area with four sets of horizontal lines (top solid, middle dashed, bottom solid).



Sign:

Date:

continued



4. Look at the plan below. It shows the view of a house from above. The white squares in the middle represent the garden. Complete the table below.

	A	B	C	D	E	F	G	H	I	J	K
1	a						e				
2											
3											
4	b						f				
5											
6	c						g				
7											
8	d						h				
9											
10											

Term 3

Room	Co-ordinates	Area (in square units)	Room area as fraction of whole house
a	A1, B1, C1, D1, E1, A3, B3, C3, D3, E3	$5 \times 3 = 15$	$\frac{15}{100}$ or 0,15
b		$5 \times 2 + 2 = 12$	
c			
d			
e			
f			
g			
h			

5. Draw your dream house:

a. From above (top view).

b. From the front.

Views everywhere

How fast can you identify the view. Tick the correct answer.



top front side



top front side



top front side



top front side



top front side



top front side

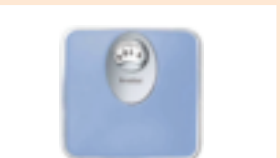

top front side



top front side



Sign: _____
Date: _____

continued

Find all the quadrilaterals in this picture.

Can you identify the same quadrilaterals in your class?

Measure their sides.



1. Answer the following questions:

- a. You know the lengths of 3 sides of a parallelogram: 14 cm, 9 cm and 9 cm. Is that enough information to work out the 4th side? If so, what is it? Make a drawing to support your answer.

Continue on an extra sheet of paper

- b. You know the lengths of 4 sides of a pentagon: 3 cm, 4 cm, 3.5 cm and 6 cm. What will the 5th side be? Make a drawing to support your answer.

Continue on an extra sheet of paper

- c. What do we name a shape where not all sides are equal?

- d. Circle the irregular shapes. Name each shape



2. How can you tell that there is something wrong with this diagram?

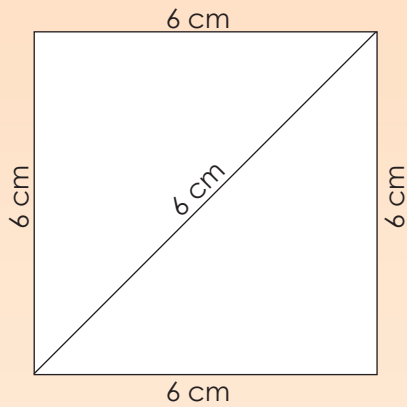

Blank writing area with horizontal dashed lines for notes.

3. Draw the following:

a. A rectangle with sides: 4,5 cm and 14 mm.

5x4 grid for drawing a rectangle with sides 4.5 cm and 14 mm.

b. A square with sides of 2,3 cm.

5x5 grid for drawing a square with sides of 2.3 cm.

c. An irregular pentagon with one side that equals to 18 mm.

5x4 grid for drawing an irregular pentagon with one side of 18 mm.

d. An irregular hexagon with all sides of different length.

5x4 grid for drawing an irregular hexagon with all sides of different length.

Magazine or newspaper search

Find the following shapes in a magazine: parallelogram, rectangle and a square. Paste it here and describe it according to angles and sides.

Blank box for pasting a shape and describing it.

Blank box for pasting a shape and describing it.

Blank box for pasting a shape and describing it.



Sign: _____
Date: _____



1. Identify the angles that are smaller, bigger and equal to 90° .

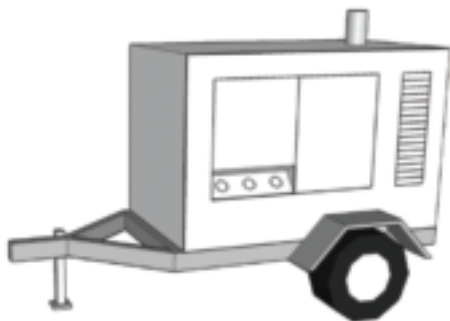
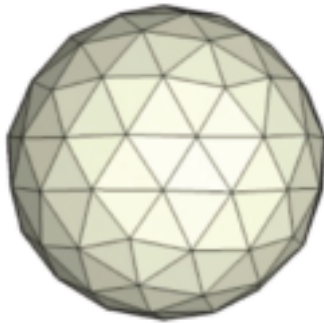
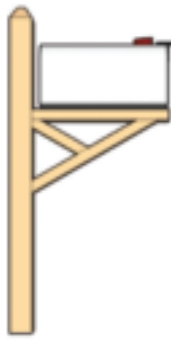

Angles smaller than 90°

Angles bigger than 90°

Angles equal to 90°

An angle of less than 90° is an acute angle.

An obtuse angle is more than 90° but less than 180° .
A reflex angle is more than 180° but less than 360° .

An angle equal to 90° is a right angle.

3. Say if the shown angles are bigger, smaller or equal to 90° and give them their correct names: acute, right, obtuse or reflex.

a.

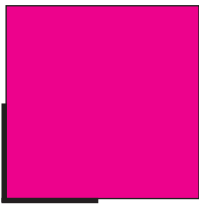

b.



c.

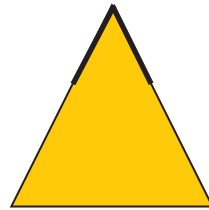

d.

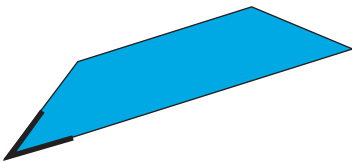

e.

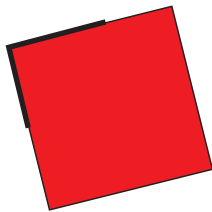

f.

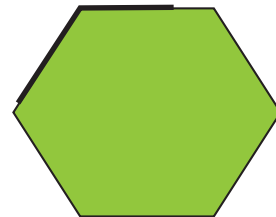

I am an architect

Draw a building with angles bigger, smaller, and equal to 90° .



Sign:

Date:

Look at the pictures. Find angles that are smaller and angles that are bigger than 90° on the South African flag.



1. Outline at least 2 angles that are bigger than 90° in red, and/or 2 angles that are less than 90° in blue in each photograph.

a.



b.



c.

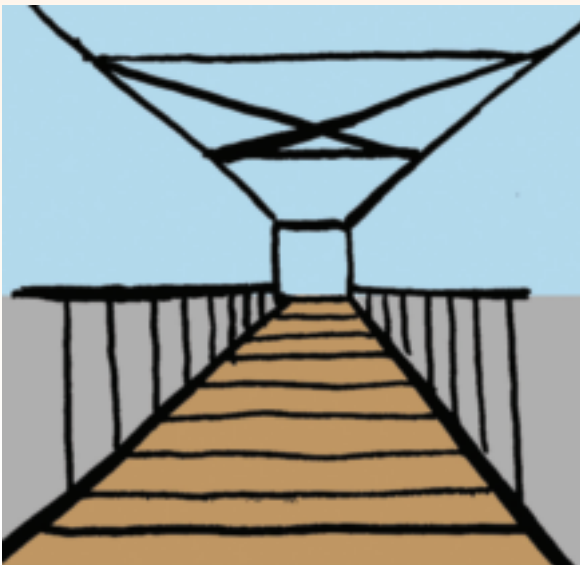

d.



2. On the protractor draw in red:

a. An angle bigger than 90° .

b. An angle smaller than 90° .

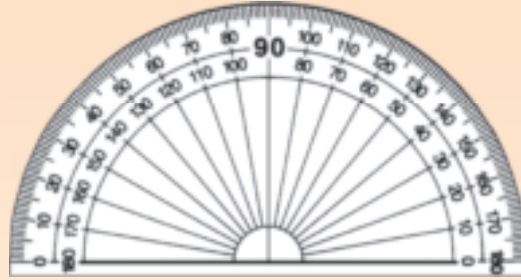
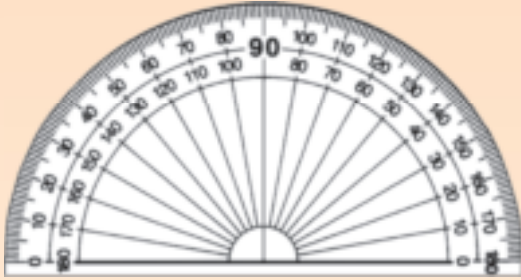

c. Tick which protractor/s shows an angle bigger than 90° .

i.



ii.



iii.



d. Tick which protractor/s shows an angle smaller than 90° .

i.

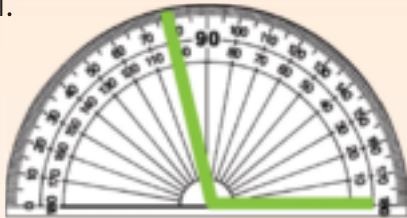

ii.



iii.



3. Tick the angles that are bigger than 90° in red and those that are smaller than 90° in blue. Name the type of angle. Name the type of angle.

a.

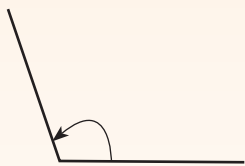

b.

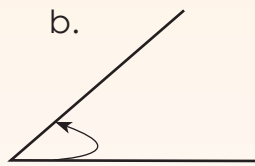

c.

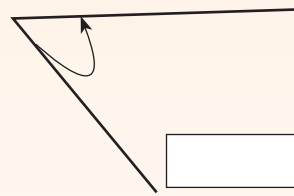

d.

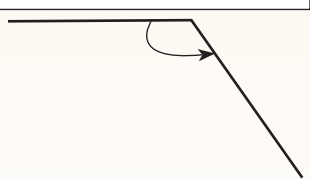

e.

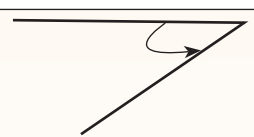

f.

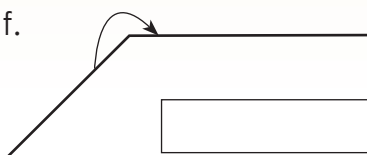

I am an architect

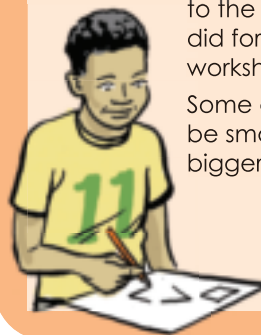

Add more angles to the drawing you did for the previous worksheet. Some angles should be smaller and others bigger than 90° .

Sign:

Date:

Revise the following. Say which shape is the original shape.

Reflection

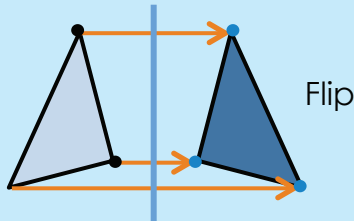

Rotation

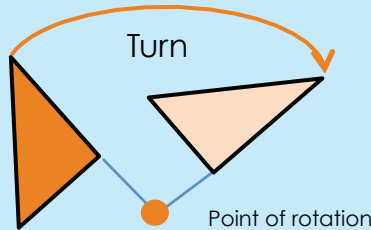

Translation

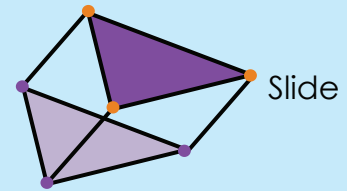

1. In nature we get the most beautiful examples of reflections. Show the line of reflection on each picture and then describe each reflection.

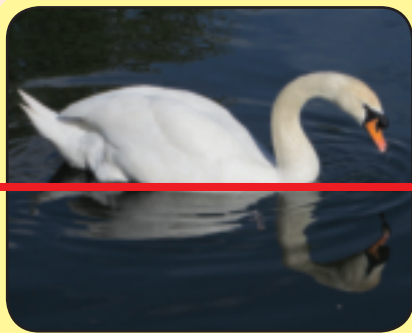

The centre line is called the line of reflection or mirror line.

The line of reflection is horizontal. The reflection of the elephants, trees and island have the same size as the original image.

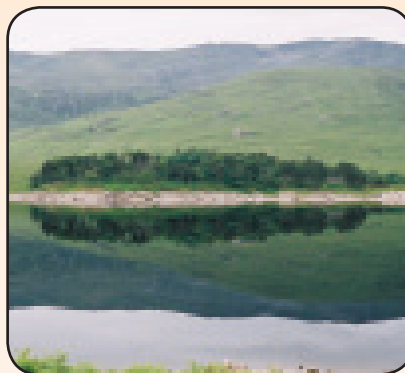



2. Find a picture on reflection, paste it here and describe it.

2. Show the centre of rotation and describe each rotation. Here are some words that might help you to describe the rotation: distance from the centre, circle around the centre, point of rotation, angle. Note that in picture b we have two examples



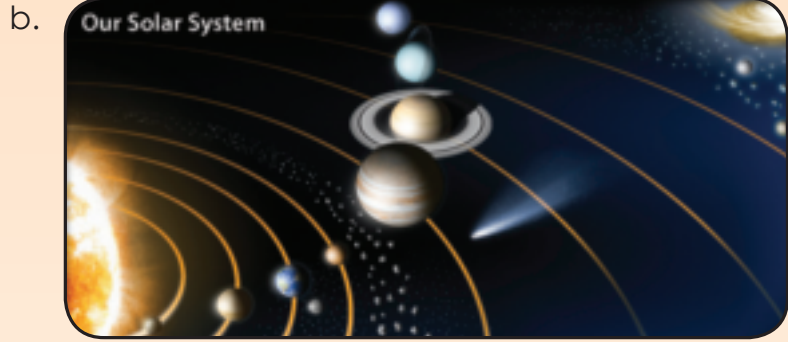

3. Describe the translation. Here are some words that will help you to describe the translation: moving, rotating, not rotating, reflecting, not reflecting, same distance, same direction, shapes.







Maths and Nature



Describe this plant using transformations.



Sign: _____
Date: _____



- What does enlargement mean?
- What does reduction mean?
- If we don't have grid paper can we still reduce or enlarge items?
- Yes, by using a ruler!

1. Say whether the following have been enlarged or reduced.

<p>a.</p>	<p>b.</p>	<p>c.</p>	<p>d.</p>
-----------	-----------	-----------	-----------

2. Explain what happened with the shape using words such as enlarge and reduce.

a.

1.5 cm, 1 cm, 3 cm, 2 cm, 6 cm, 4 cm

b.

2 cm, 1 cm, 4 cm, 2 cm, 4 cm, 8 cm

c.

3 cm, 3 cm, 1 cm, 1 cm



3. Use the grid paper below to draw the following:

- a. Draw a rectangle with an area of six blocks. Then draw the same rectangle reduced by two in green. Then draw a rectangle enlarged by three in blue.

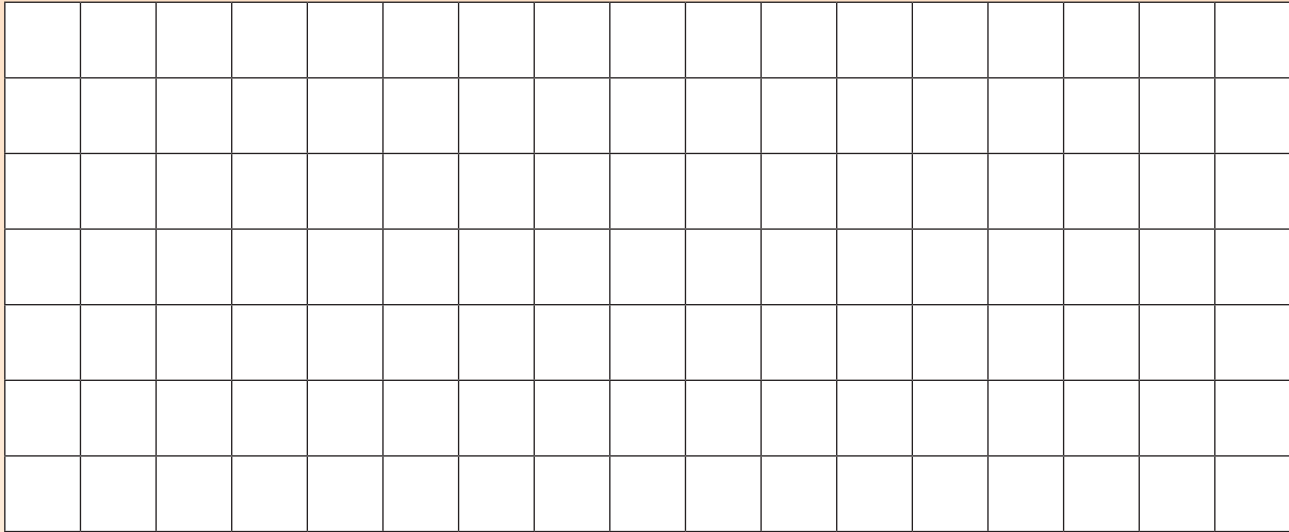

- b. If each block in the grid above is 1 cm by 1 cm, explain the reduction and enlargement in cms.

- c. Draw any object in red. Reduce it to half its size, in blue. Explain your reduction in cm.

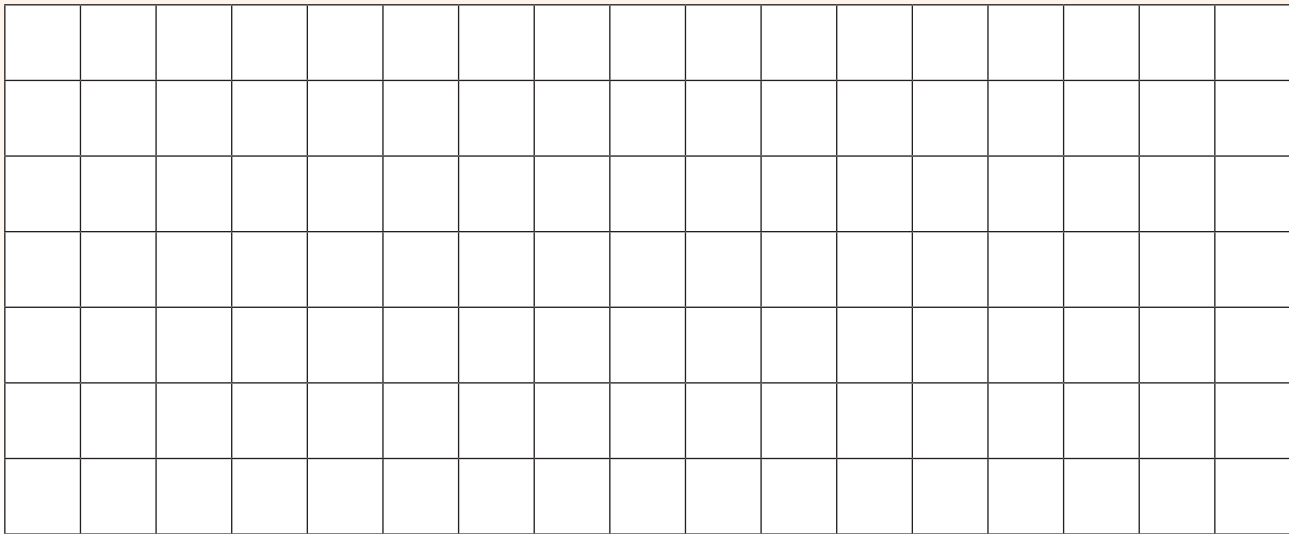

continued



Sign: _____
Date: _____

Look at the diagram below. Discuss it in your groups.

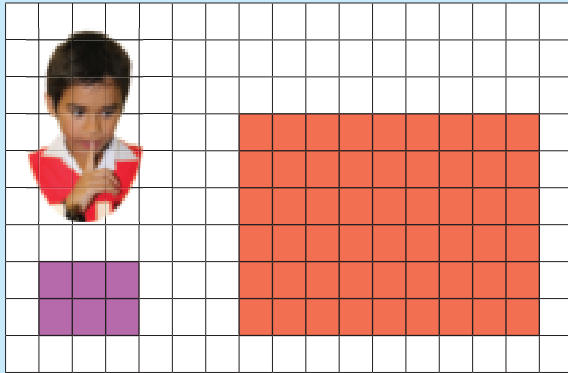

Purple rectangle:
The length = 3
The width = 2

Red rectangle:
The length = 9
The width = 6

The length of the **red rectangle** is **3** times more than the **purple rectangle**.

$$3 \times 3 = 9$$

The width of the **red rectangle** is **3** times more than the **purple rectangle**.

$$2 \times 3 = 6$$

Therefore, we say that the red rectangle is **enlarged 3** times.

4. Look at the rectangles. Answer the questions below.

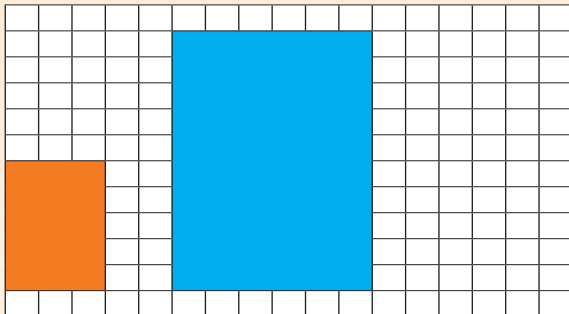

Orange rectangle

a. The length =

b. The width =

Blue rectangle

c. The length =

d. The width =

e. The length of the blue rectangle is times more than the orange rectangle.

f. The width of the blue rectangle is times more than the orange rectangle.

g. The blue rectangle is enlarged times.

5. Answer the following questions:

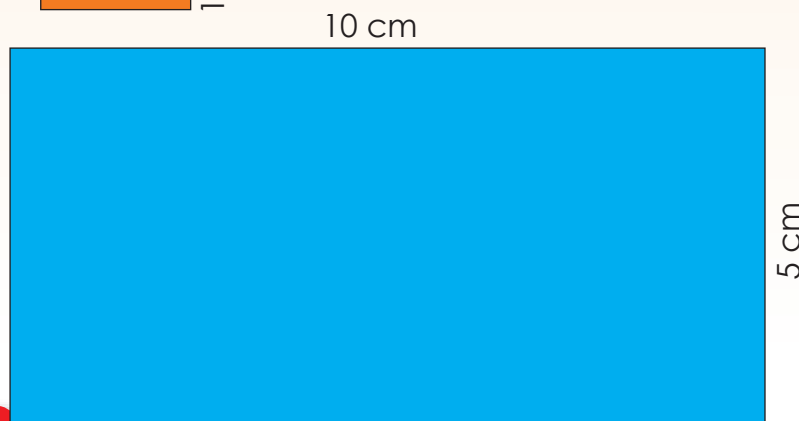
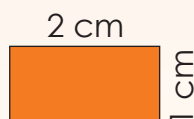

Orange rectangle

a. The length =

b. The width =

Blue rectangle

c. The length =

d. The width =

e. The blue rectangle is enlarged times.

6. By what factor is this shape enlarged? Write down all the steps.

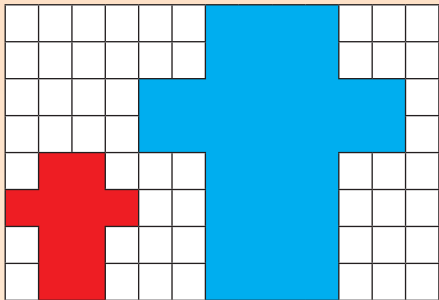

Blank space for writing the steps to determine the enlargement factor.

7. Enlarge the rectangle by:

a. 4

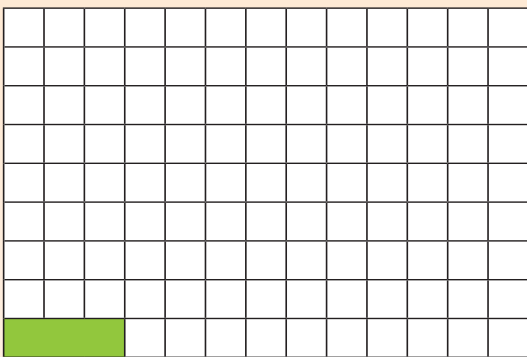

b. 2

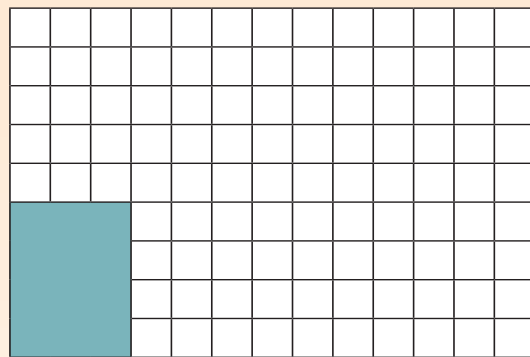

8. Complete the table. Make drawings if needed.

Rectangle	Perimeter	Area	Enlarge by:	Perimeter	Area
a. Length: 4 cm Width: 2 cm			5 Length: Width:		
b. Length: 3 cm Width: 2 cm			8 Length: Width:		
c. Length: 7 m Width: 5 m			6 Length: Width:		
d. Length: 9 m Width: 8 m			10 Length: Width:		

I am an artist

What do you need:
Square paper

What to do:
Find or draw a picture. Enlarge the picture by 2.

Sign:

Date:

Look at the pictures. What do you think is the temperature for each?

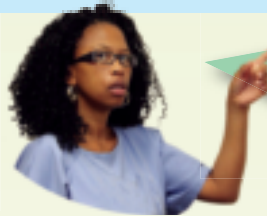

The degree Celsius ($^{\circ}\text{C}$) is the metric unit for measuring temperature.

1. Choose the correct answer.

- What happens to the liquid in the thermometer when the temperature rises?
 - The mercury rises.
 - The mercury drops.
- What happens to the liquid when the temperature drops?
 - The mercury rises.
 - The mercury drops.
- The temperature on a very hot day in South Africa is:
 - 15°C
 - 35°C
 - 0°C
- The temperature on a very cold day in South Africa is:
 - 18°C
 - 28°C
 - 4°C
- The temperature shown on the thermometer is:
 - 15°C
 - 24°C
 - 29°C

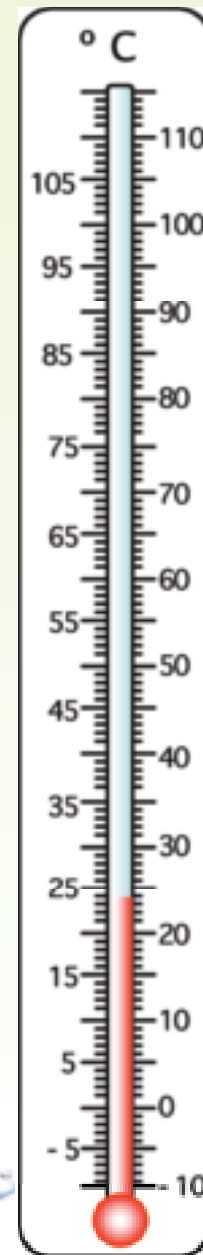

Water boils at 100°C

37°C
Body temperature

35°C
Hot day

15°C
Cool day

0°C
Water freezes



2. Match the temperature to the correct thermometer.

Body temperature = 37 °C

Soup temperature = 45 °C

Cool drink temperature = 10 °C

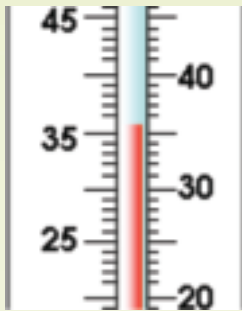

b.

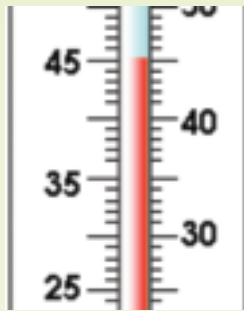

c.

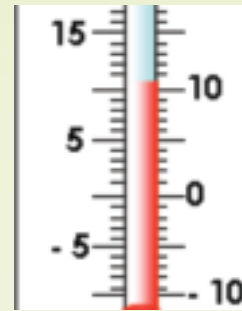

3. Write down each temperature.

a. b. c. d. e.

4. Record this week's minimum and maximum temperature.

Sunday	Monday	Tuesday	Wednesday	Thursday	Friday	Saturday
Min: <input type="text"/>	Min: <input type="text"/>	Min: <input type="text"/>	Min: <input type="text"/>	Min: <input type="text"/>	Min: <input type="text"/>	Min: <input type="text"/>
Max: <input type="text"/>	Max: <input type="text"/>	Max: <input type="text"/>	Max: <input type="text"/>	Max: <input type="text"/>	Max: <input type="text"/>	Max: <input type="text"/>

Describe the temperature for the week:

Handwriting practice area with horizontal lines.

Celsius and Fahrenheit

Have you ever heard of the word Fahrenheit? Find out what it means. How does it differ from Celsius?

Sign:

Date:

What did we learn so far? How to read a thermometer.

Look at the top of the red line.



Look down at the number line for the nearest ten.



Count up the lines to find the exact temperature.



Write the temperature with a degree mark ° and a C.

There are numbers below the zero. What does this mean?



It means minus ... something.



I am sure our teacher will show us.



1. Answer the following questions on temperature:

- What is the temperature on a hot, sunny day? Show it on the thermometer on the right hand side.
- What does it mean for the temperature to be 2 degrees below zero?

Show it on the thermometer.

- What sign would you use to show this number is below zero?

2. Write the following temperature in numbers and symbols:

- 5 degrees Celsius.
- 3 degrees Celsius below zero.
- 10 degrees Celsius above zero.
- 10 degrees Celsius below zero.
- The temperature is minus 2 this morning in Joburg.



I understand now. If the temperature falls below 0 °C (zero degrees Celsius) we use negative numbers to say how far below zero it has fallen. Such as - 5 °C.

3. Is it very often below zero degrees Celsius in South Africa? Explain your answer.

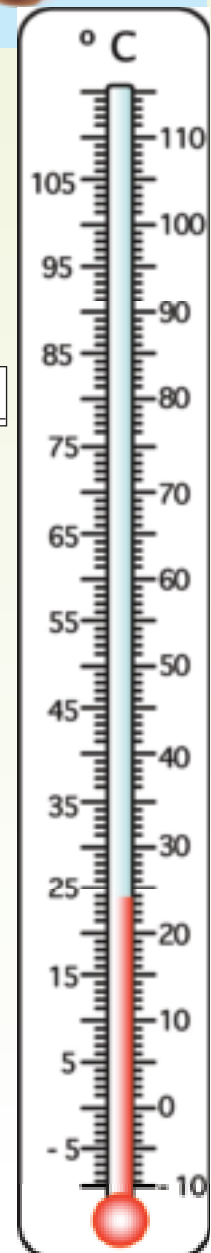

4. Write down each temperature.

a. b. c. d. e.

- f. Which temperature is the coldest?
- g. Which temperature is the warmest?

5. Complete the following:

- a. The temperature -6°C is colder than -4°C as it is 2° less than .
- b. The temperature 7°C is warmer than -8°C as it is more than .
- c. The temperature -9°C is colder than -6°C as it is less than .
- d. The temperature -5°C is warmer than -10°C as it is more than .
- e. The temperature -15°C is colder than -9°C as it is less than .

6. Write down what you will do if it is below zero in your area.

Temperature and negative numbers

Make the same cards as below from paper or cardboard. Cut them out and place them in order from the smallest to the largest number.

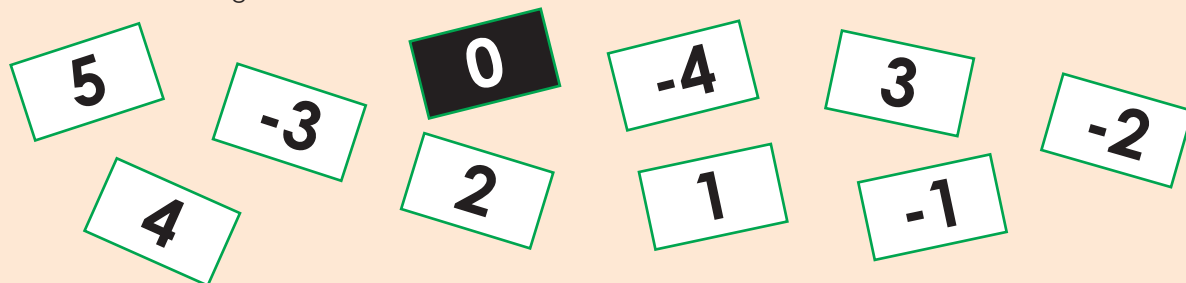

Sign:

Date:

Look at the pictures and compare it to the thermometer used in the previous worksheet. Explain how you think each one is used.



We use thermometers to measure the temperature of the air, our bodies, food, and many other things.

There are analogue and digital thermometers. An analogue thermometer shows the temperature directly on a scale or dial; a digital thermometer changes the analogue reading into an electric one shown as numbers on a display screen.

1. Fill in the correct answers

- Temperature is measured in many different scales, including _____, _____, and _____ scales.
- The units of the _____ and _____ scales are called degrees; the units of the Kelvin scale are called kelvins.
- The symbol for degree is ____.
- We use the _____ in South Africa to measure temperature.

Share this table with an adult that needs to convert Fahrenheit to Celsius or vice versa.



2. Complete the table below.

Temperature	Fahrenheit	Celsius
Water boils	212 °F	a.
Water freezes	32 °F	b.
Normal human body temperature	98,6 °F	c.
Room temperature	70 °F	d.

3. Write the digital times in words.

- _____
- _____
- _____
- _____
- _____

4. Use the temperatures above to answer the questions.

a. What will ascending order mean when we work with temperature?

b. Write the temperatures in Question 3 in ascending order.

c. What will descending order mean when we work with temperature?

d. Write the temperatures in Question 3 in descending order.

e. When in everyday life will we write temperature in ascending or descending order? Why?

5. We have learnt that normal body temperature is 37° . Studies show us that body temperature can vary from person-to-person, their age, what they have been doing, the time of the day and the part of the body you take the temperature from. This is the range for the normal body temperature. Fill in all the other possible readings you can have on a digital thermometer counting in tenths.

36,1 ^o												37,2 ^o
-------------------	--	--	--	--	--	--	--	--	--	--	--	-------------------

Challenge

Beneath Earth's surface, the temperature increases 10°C every kilometre. Suppose that the surface temperature is 22°C , and the temperature at the bottom of a gold mine is 45°C . What is the depth of the gold mine?

Sign: _____
Date: _____



What part of the square is yellow? blue? green? red? purple? Give your answer in fractions.

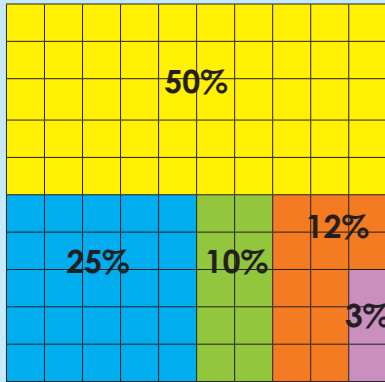

What does % mean?



The symbol for percentage is %.



Oh! I have 80 percent for my test.



Yes, it means you have 80 out of 100 for your test.

Term 3

1. What fraction of the square is blue?
2. What percentage of the square is blue?

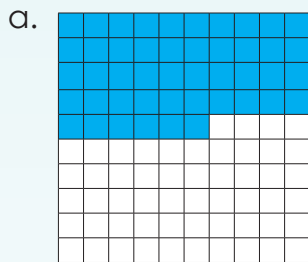

i.

ii.

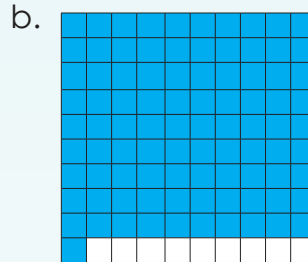

i.

ii.

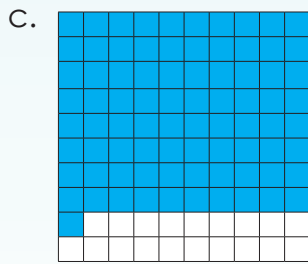

i.

ii.

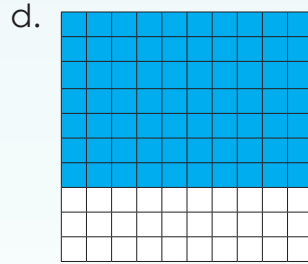

i.

ii.

3. Colour in $\frac{73}{100}$.
Write your answer as a percentage.

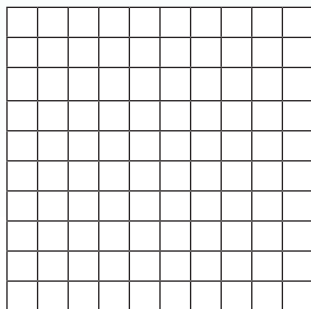

3. Colour in 99 per cent.
Write your answer as a fraction.

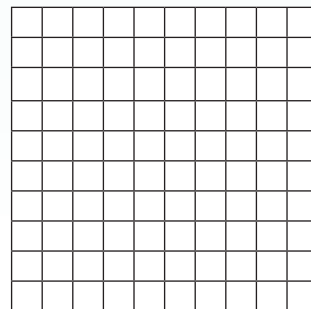

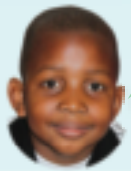

What did we learn so far?



Parts of a whole can be described using percentages too.



A percentage is an amount out of 100 and is written like this: %.

5. Complete the following:

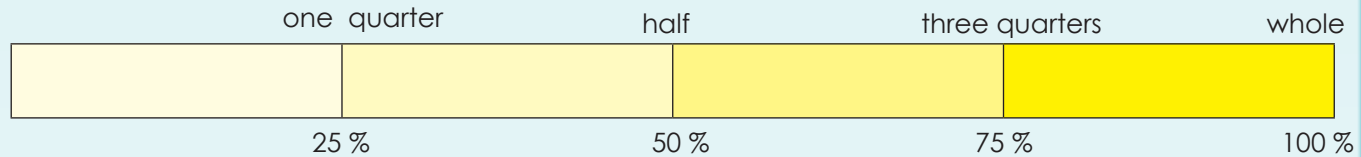

- a. 100 % means all of a whole.
- b. 50 % means of a whole.
- c. 25 % means of a whole.
- d. 75 % means of a whole.

6. What percentage of the circle is red?

a.

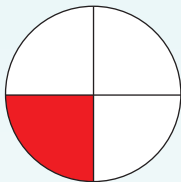

b.

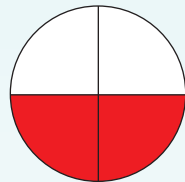

c.

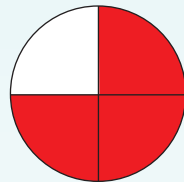

d.

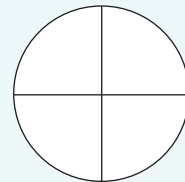

7. Look at the diagram and answer the questions below.

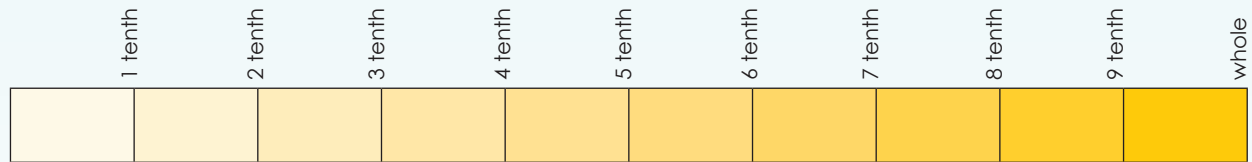

- a. 1 tenth = %
- b. 4 tenths = %
- c. 9 tenths = %

What does cent mean?

century

centipede

centimetre

cent

percent



Sign:
Date:

Match the fractions, decimal fractions and percentages that stand for the same amount:

75 %

 $\frac{1}{2}$

28 %

 $\frac{28}{100}$

30 %

50 %

 $\frac{3}{4}$ $\frac{25}{100}$

0,01

 $\frac{3}{10}$

0,75

 $\frac{1}{4}$

0,28

 $\frac{1}{10}$

0,1

0,5

 $\frac{1}{100}$

25 %

0,3

1 %

0,25

10 %

1. Complete the table below.

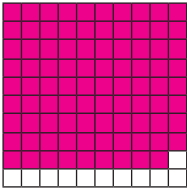
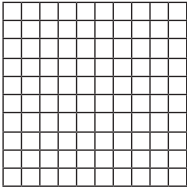
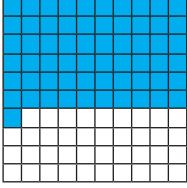
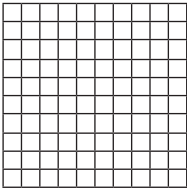
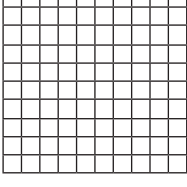
	Fraction	Percentage	Decimal fraction
	$\frac{89}{100}$		0,89
		58%	
			
	$\frac{1}{4}$		
			0,75

2. Complete the following:

a. Colour in one half of each shape.

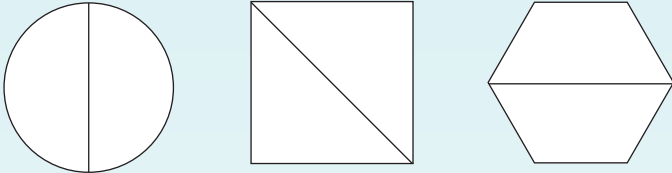

A **half** can be written...

As a fraction:
 As a decimal:
 As a percentage:

b. Colour in one quarter of each shape.

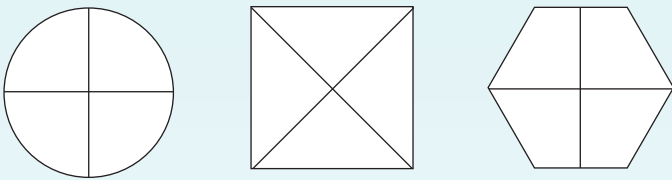

A **quarter** can be written...

As a fraction:
 As a decimal:
 As a percentage:

3. Answer the following:

- a. What is 50 % of R1,00?
- b. What is 0,5 of R1,00?
- c. What is $\frac{1}{2}$ of R1,00?
- d. What is 25 % of R1,00?
- e. What is 0,25 of R1,00?
- f. What is $\frac{1}{4}$ of R1,00?

4. Complete the following:

There are 120 children in grade 6.

- a. 50 % of the children are boys. How many children are boys?
- b. 25 % of the children like strawberry ice cream. How many children like strawberry ice cream?
- c. What percentage of children like other flavoured ice-creams?
 How many children like other flavoured ice-creams?

Advertisement search

Go through a newspaper. See how many times can you find the symbol %.

Bring it to class to share with the other children.



Sign:
 Date:

Look at the pictures below. Make up your own prices to explain the discount.

All shoes 50 % discount.



All jackets 25 % discount.



All skirts 10 % discount.



1. Look at the diagrams and answer the following:

a. What is 20 % of 100? 20

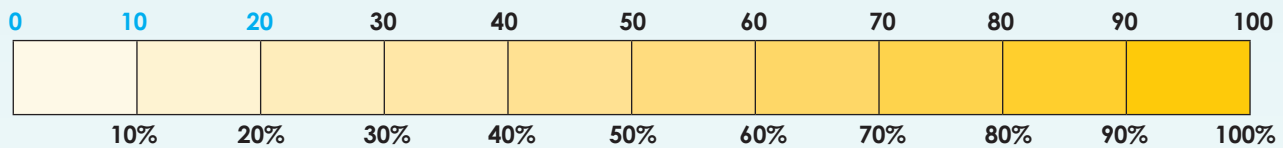

b. What is 40 % of 200?

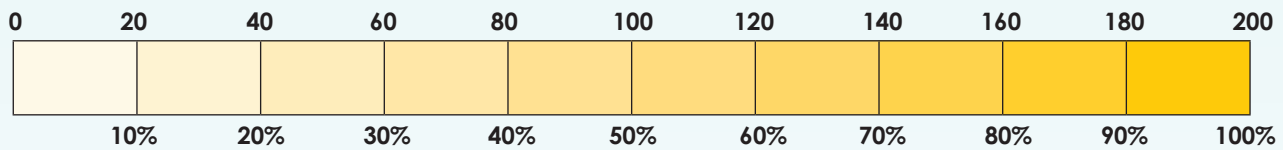

c. What is 60 % of 300?

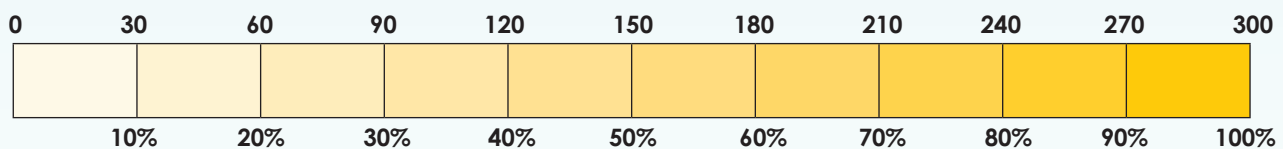

d. What is 80 % of 400?

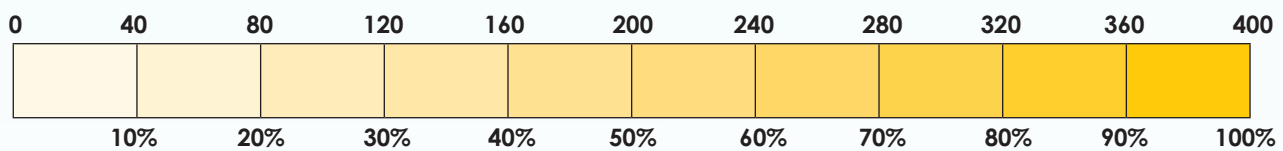

e. What is 70 % of 500?

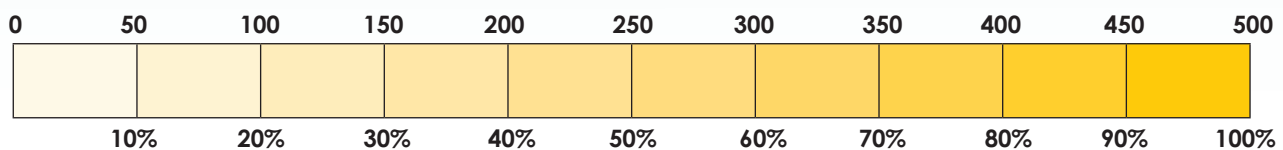

2. Look at the diagram and answer the questions.

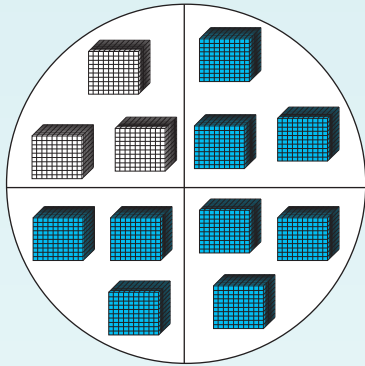

 = 1 000 small cubes

- a. How many small cubes are there?
- b. How many small blue cubes are there?
- c. How many small white cubes are there?
- d. What percentage of the small cubes are blue?
- e. What percentage of the small cubes are white?

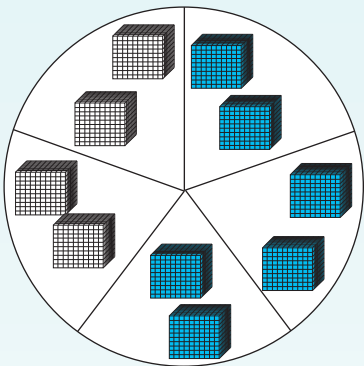

- f. How many small cubes are there?
- g. How many small blue cubes are there?
- h. How many small white cubes are there?
- i. What percentage of the small cubes are blue?
- j. What percentage of the small cubes are white?

3. Answer the following:

- a. What is 50 % of R100?
- b. What is 25 % of R100?
- c. What is 50 % of R50?
- d. What is 25 % of R50?

4. The music shop is having a sale in which they are offering 30% off the marked price of a CD you want to buy. Another shop nearby is offering the same CD at the same price, and the sale sticker says you can get $\frac{1}{4}$ of the price off. Which shop will you buy from and why?

Advertisement search

Go through a newspaper.

See how many times can you find discounts offered on goods.



Sign:
Date:

What is in my basket? Calculate the total cost of each basket.

Basket 1

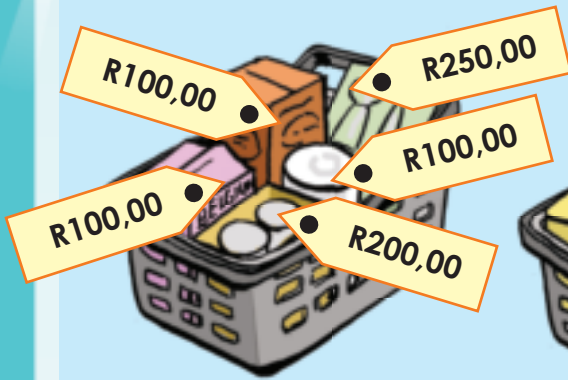

Basket 2

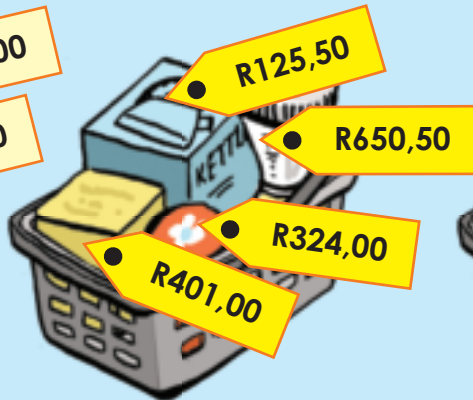

Basket 3



1. How much do I save on each basket?

Which basket	Discount	Amount after discount	Savings
Basket 1 	25 %		
Basket 2 	50 %		
Basket 3 	10 %		

- a. Which basket cost the least?
- b. Which basket cost the most?
- c. On which basket did you save the least?
- d. On which basket did you save the most?
- e. What is the total cost of all the baskets before discount?
- f. What is the total cost of all the baskets after discount?

2. Here are four families' groceries for the month.

LUCKY CUSTOMER Scratch card
 Three trolleys in a row. 10 % off.
 Four trolleys in a row. 20 % off.
 Five trolleys in a row. 50 % off.



R1 500,00



R1 275,00



R1 687,25



R999,99

Total cost	Discount coupons	Total amount
Family 1 	 	
Family 2 	Lucky Customer scratch card. 	
Family 3 	Lucky Customer scratch card. 	
Family 4 	Lucky Customer scratch card. 	

Shopping search

Go to your nearest shop or shopping centre.
 Find out about discount prices.
 How much can you save?



Sign: _____
 Date: _____

Say where you think you will look for the following world data.

Today's population

Earthquakes

Children liking chocolate ice cream

Learners with cell phones.

Largest countries

Language spoken

1. "Do the children in our school eat a healthy breakfast?" What do you normally eat for breakfast? Tick whether you normally eat any of these things for breakfast.

- a) Cooked porridge
- b) Cereal with added sugar
- c) Cereal without added sugar
- d) Bread
- e) Fruit
- f) Yoghurt
- g) I don't eat breakfast
- h) Something else (please say what).

2. You need to find out what the favourite chocolate of each learner in your school.

a. What type of data will you collect?

b. How will you collect it?

c. Where will you find the information?

d. What will the data tell us?

e. Do I think the data can help us to answer the question? Why?

3. Draw up a frequency to record the data given below.
Put the names in order starting with the most common name.

Betty's tally for people called Jonathan.
 IIII IIII IIII
 IIII IIII IIII
 IIII IIII IIII
 IIII IIII IIII
 IIII IIII IIII
 IIII IIII IIII

Bongi: "Quite a few people are called Mbali."
 IIII IIII IIII
 IIII IIII IIII
 IIII IIII IIII
 IIII IIII IIII
 IIII IIII IIII
 IIII IIII IIII

Sam said: "120 people are called Sam."

Susan said: "127 people are called Max."

Bongi said: "Another 52 people are called Mbali."

Thabo said: "I was surprised to find that my name did not win!" "99 people have the same name as me."

Lilly said: "128 people are called Peter."

Betty said: "I found 2 more people with the name Jonathan."

Thabo found more people with the same name.

Lilly said: "I forgot about the 5 Peter's living in Second Avenue."

Susan said: "I forgot my brother and cousin are also called Max."

Names	Frequency

Remember our tally competition ...

In pairs we are going to see who can count the tallies this time the fastest.

Sign:

Date:

Look at the table. Make your own story using words such as.

Temperature	Tally
0 °C – 5 °C	
6 °C – 10 °C	
11 °C – 15 °C	
16 °C – 20 °C	
20 °C – 25 °C	

group

temperature

tally

table

1. Grouping data

When a large amount of data has to be collected it may help to tally it.

The following tally chart represents the ages of 200 people who went to a school concert.



Age	Tally	Frequency
0–9		9
10–19		
20–29		
30–39		
40–49		
50–59		
60–69		
70–79		
80–89		
90–99	/	

a. Complete the table by filling in the frequencies.

b. How are the ages grouped?

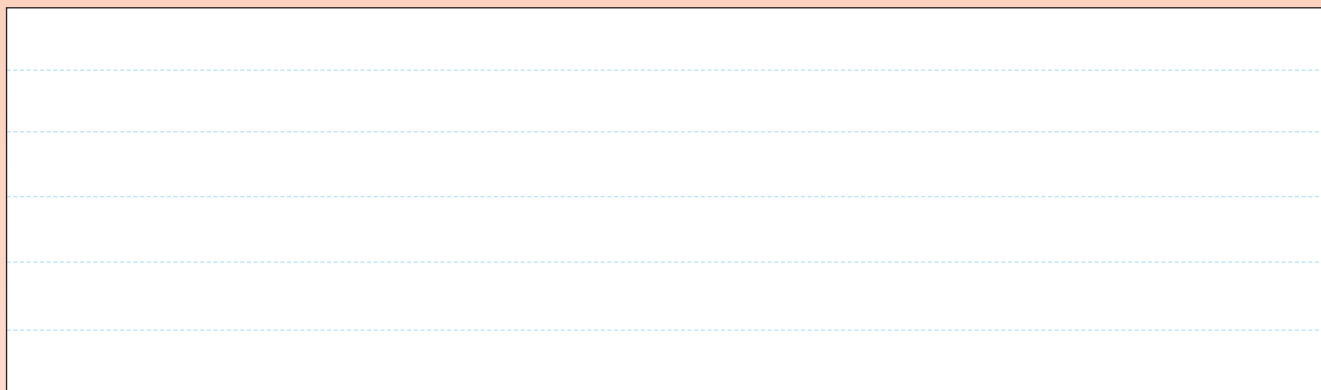

c. You decide to group the ages differently. The first group is 0-5. Group the rest of the ages. Draw a table like the one on the previous page and complete it.

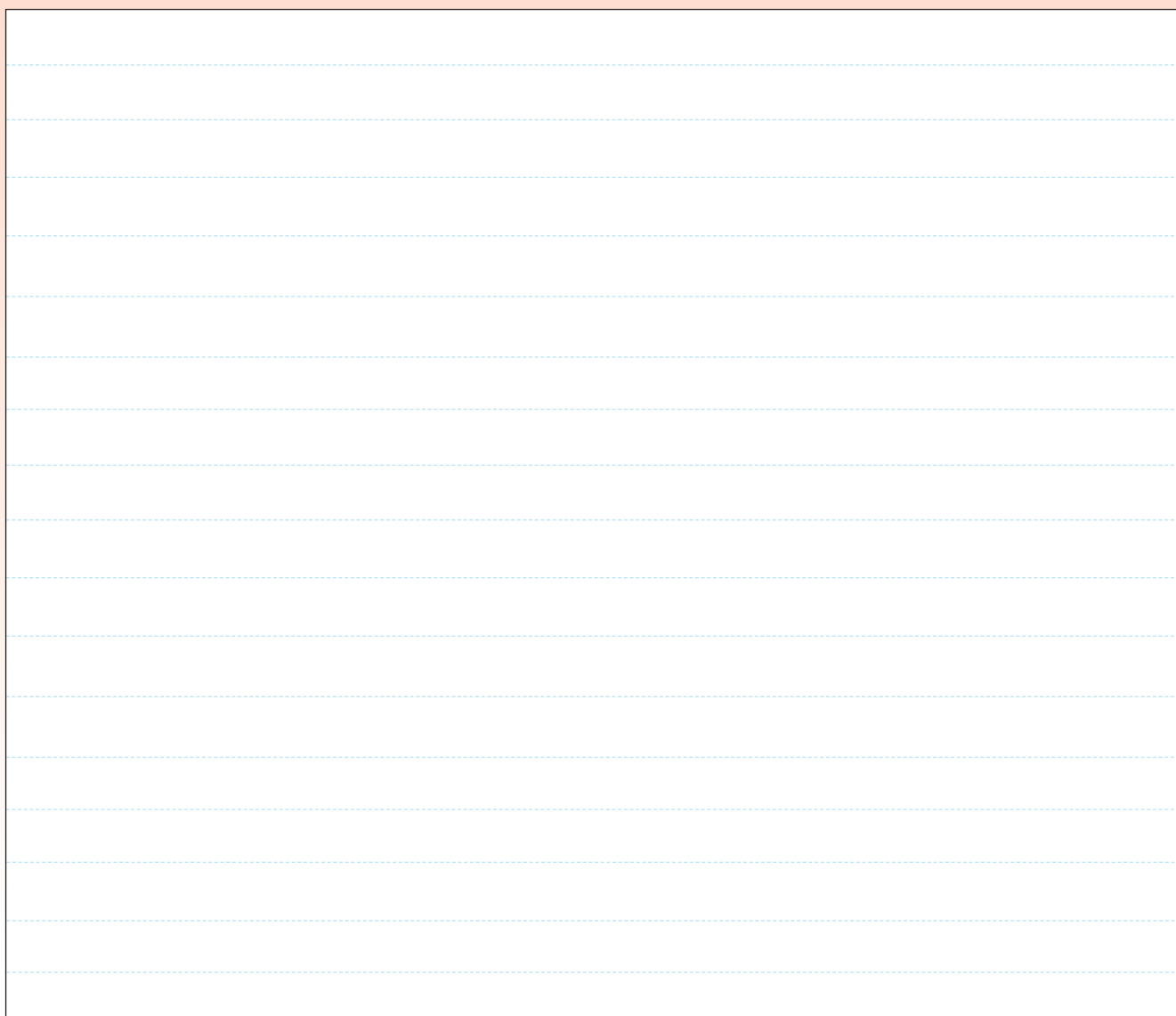

continued



Sign: _____
Date: _____

2. You got the information below on a piece of paper. Record this data onto the table on the next page.

Temperature

1°C	✓✓✓✓✓✓
2°C	✓✓✓✓✓✓✓✓✓✓
3°C	✓✓✓✓✓✓✓✓✓✓✓✓
4°C	✓✓✓✓✓✓✓✓✓✓✓✓✓✓
5°C	✓✓✓✓✓✓✓✓✓✓✓✓✓✓✓✓
6°C	✓✓✓✓✓✓✓✓✓✓✓✓✓✓✓✓✓✓
7°C	✓✓✓✓✓✓✓✓✓✓✓✓✓✓✓✓✓✓✓✓
8°C	✓✓✓✓✓✓✓✓✓✓✓✓✓✓✓✓✓✓✓✓✓✓
9°C	✓✓✓✓✓✓✓✓✓✓✓✓✓✓✓✓✓✓✓✓✓✓✓✓
10°C	✓✓✓✓✓✓✓✓✓✓✓✓✓✓✓✓✓✓✓✓✓✓✓✓✓✓
11°C	✓✓✓✓✓✓✓✓✓✓✓✓✓✓✓✓✓✓✓✓✓✓✓✓✓✓✓✓
12°C	✓✓✓✓✓✓✓✓✓✓✓✓✓✓✓✓✓✓✓✓✓✓✓✓✓✓✓✓✓✓
13°C	✓✓✓✓✓✓✓✓✓✓✓✓✓✓✓✓✓✓✓✓✓✓✓✓✓✓
14°C	✓✓✓✓✓✓✓✓✓✓✓✓✓✓✓✓✓✓✓✓✓✓✓✓✓
15°C	✓✓✓✓✓✓✓✓✓✓✓✓✓✓✓✓✓✓✓✓✓✓✓✓
16°C	✓✓✓✓✓✓✓✓✓✓✓✓✓✓✓✓✓✓✓✓✓✓✓
17°C	✓✓✓✓✓✓✓✓✓✓✓✓✓✓✓✓✓✓✓✓✓
18°C	✓✓✓✓✓✓✓✓✓✓✓✓✓✓✓✓✓✓✓✓
19°C	✓✓✓✓✓✓✓✓✓✓✓✓✓✓✓✓✓✓✓✓
20°C	✓✓✓✓✓✓✓✓✓✓✓✓✓✓✓✓✓✓✓✓
21°C	✓✓✓✓✓✓✓✓✓✓✓✓✓✓✓✓✓✓✓✓
22°C	✓✓✓✓✓✓✓✓✓✓✓✓✓✓✓✓✓✓✓✓
23°C	✓✓✓✓✓✓✓✓✓✓✓✓✓✓✓✓✓✓✓✓
24°C	✓✓✓✓✓✓✓✓✓✓✓✓✓✓✓✓✓✓✓✓

Mathematics Grade 6

Cut-out 6

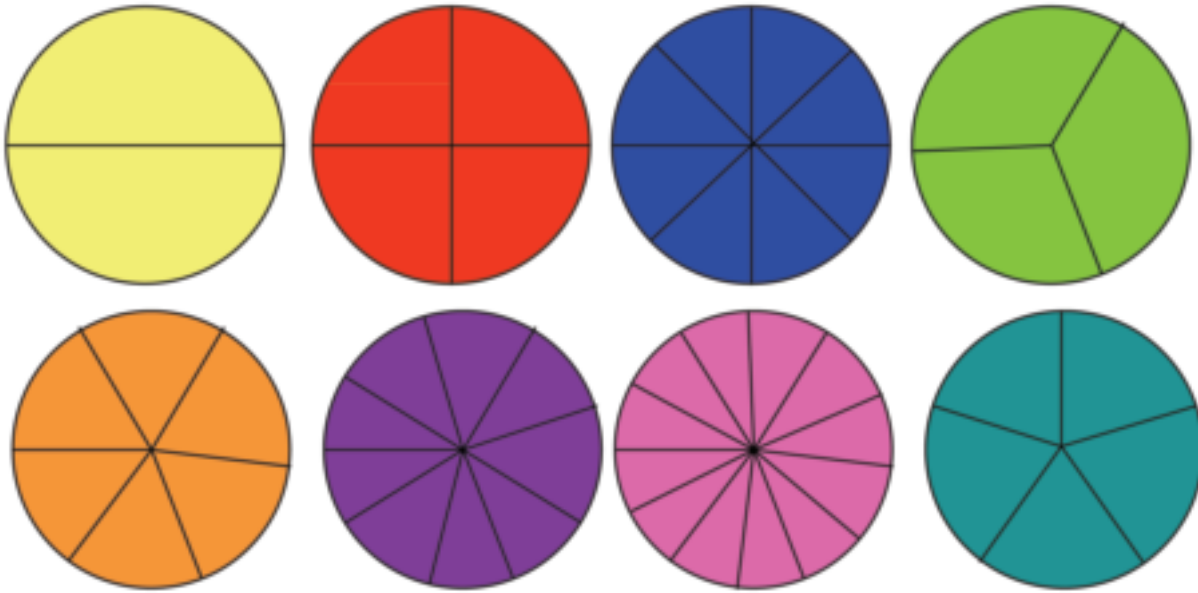

Operation Snap

increase	subtract	multiply	minus	sum
times	add	divided by	decrease	product
share equally	take away	and	groups of	plus
total	divide	lots of	difference between	divisible by





Temperature	Tally	Frequency

Tally competition ...

In pairs see who can count the tallies the fastest.



Sign:

Date:



How many apples were eaten this week at the school?



= 10 apples



= 5 apples

Monday



Tuesday



Wednesday



Thursday



Friday



Term 3

1. Look at the pictograph and answer the questions.

Favourite food in our school

Key:



= 20 children



= 10 children

Pap and stew



Hamburger



Hot dog



Curry and rice



Sandwiches



- How many children have chosen pap and stew as their favourite meal?
- How many children have chosen sandwiches as their favourite meal?
- How many children have chosen hamburgers as their favourite meal?
- How many more children like the most favourite meal than the least favourite meal?
- How many children were asked?
- What if the burger picture represented:

	Pap and stew	Hamburger	Hot dog	Curry and rice	Sandwiches
= 50 children					
= 25 children					

2. Use the pictograph to answer the questions.

Books read over the last 4 years.

Key:

 24 books

 12 books

Lydia 

Lindiwe 

Dan 

Sipho 

- How many books did Lindiwe read?
- How many more books did Lydia read than Dan?
- Two children read the least number of books. How many books did they read?
- How many books do you think Lydia, Lindiwe, Dan and Sipho will read in 8 years?

3. Answer the question on the pictograph.

2015 Housing project













Houses built Houses being built Houses planned to be built

Key:

 = 100 000 houses

 = 50 000 houses

- How many houses should still be build?
- How many houses are built?
- How many houses are in the process of being built?
- Calculate the total number of houses in this housing project.

How many did they see?

 = 25 000 insects



When and where do you think this was?

Sign:

Date:





Use colour and fraction to describe the circles below.



1. Look at the pictograph and complete the pie chart.

Bread eaten in four days.

Key:

 = 10 loaves
 = 5 loaves

Monday 

Tuesday 

Wednesday 

Thursday 

Chart title: _____

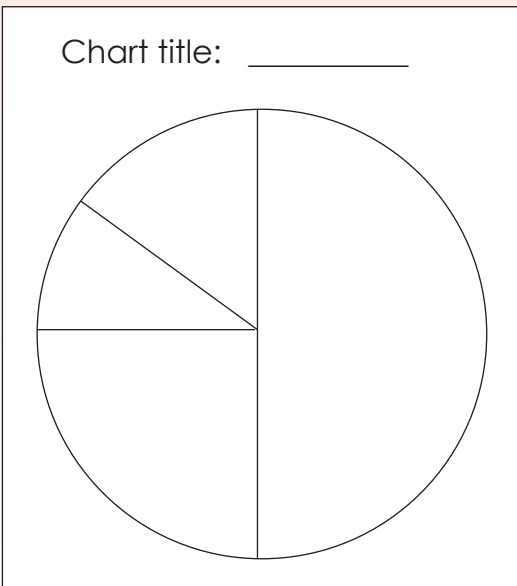

2. Answer the following questions:

- How many loaves of bread were eaten on Monday?
- How much bread was eaten on Wednesday?
- On which day was the most bread eaten?
- How many loaves were eaten in total?
- What fraction of bread was eaten on Tuesday? Thursday? Monday? Wednesday? . Remember to write your answers in the simplest form.

3. Look at the pie chart and answer the questions.

Ice cream liked by children in grade 6.

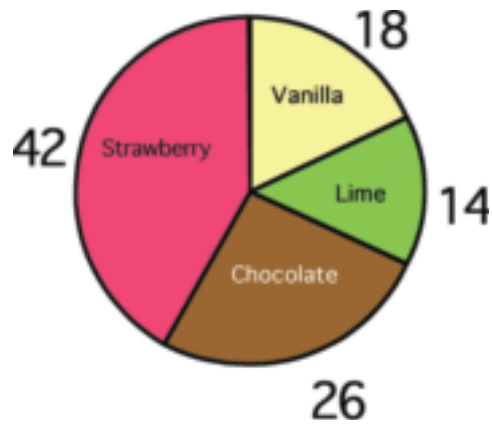

- What is the favourite ice-cream in grade 6?
- What is the least favourite ice-cream in grade 6?
- What is the difference between the favourite and the least favourite ice-cream?
- What fraction of grade 6 like strawberry ice-cream? vanilla ice-cream?
lime ice-cream?
chocolate ice cream?

4. Look at the pie chart and answer the questions.

Favourite day of the week.

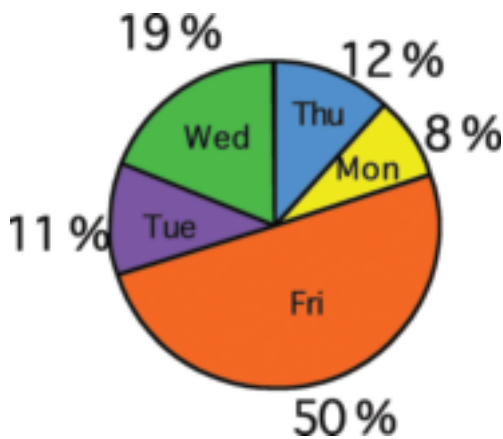

- What is the favourite day of the week?

Why do you think so?
- What is the least favourite day of the week?
- Write the following in fractions: People that like: Monday Thursday ,
Friday
- Compare question 2 and 3's pie charts.

Which circle shows ...?

$$\frac{1}{2} + \frac{1}{4} + \frac{3}{12} =$$



Sign:
Date:



How many hours do they help at home per week?



Simon

Making beds $\frac{1}{2}$ hour
Washing dishes 1 hour
Dusting 2 hours
Drying dishes $\frac{1}{2}$ hour
Clean my room $1\frac{1}{2}$ hours



Lee

Washing dishes 2 hours
Drying dishes $1\frac{1}{2}$ hour
Making beds $\frac{1}{2}$ hour
Clean my room 3 hours
Dusting 1 hours

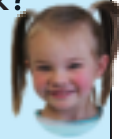

Lisa

Dusting 1 hour
Washing dishes $1\frac{1}{2}$ hours
Drying dishes $\frac{1}{2}$ hour
Cleaning own bedroom $2\frac{1}{2}$ hours
Making beds $\frac{1}{2}$ hour



Ben



Making beds 2 hours
Dusting 3 hours
Cleaning own bedroom $2\frac{1}{2}$ hours
Washing dishes $\frac{1}{2}$ hours
Drying dishes $\frac{1}{2}$ hour



Suraya

Cleaning own bedroom $2\frac{1}{2}$ hours
Making beds $\frac{1}{2}$ hour
Dusting 1 hour
Washing dishes 4 hours
Drying dishes $1\frac{1}{2}$ hour

1. Use the information above to complete the pictograph.

<p>Key:</p>  1 hour  $\frac{1}{2}$ hour	Simon	
	Lee	
	Suraya	
	Ben	
	Lisa	

2. Use the pictograph above to label you pie chart. We did the first one for you.

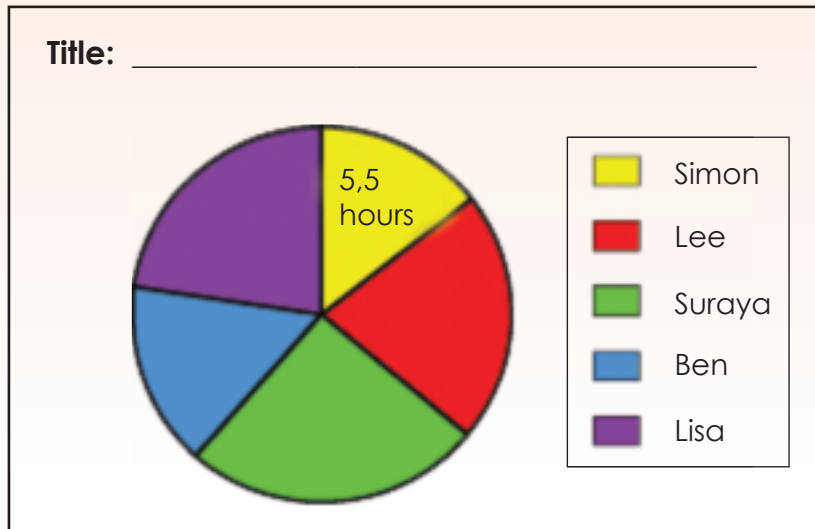

3. Look at the bar graph and answer the questions.

	Simon	Lee	Suraya	Lisa	Ben	Total
Making beds						
Washing dishes						
Drying dishes						
Dusting						
Cleaning own bedroom						



Before answering the questions below compare the table above and the bar graph on your left.



a. Write your answers in hours and minutes. What time did they spend on:

i. Making beds? hours minutes

ii. Washing dishes? hours minutes

iii. Drying dishes? hours minutes

iv. Dusting? hours minutes

v. Cleaning own bedroom?
 hours minutes

b. On what task did they spend the most time?

c. On what task did they spend the least time?

Newspaper search ...

Find a bar graph in a newspaper.

Write ten things down about the graph.

Sign:

Date:

Sign:

Date:

When we have a list of numbers as part of some data, we often find it useful to work out the average number.

I kept a record of last week's materials collected. I wonder what was the average amount of material collected.

Monday	Tuesday	Wednesday	Thursday	Friday
12 kg	2 kg	4 kg	5 kg	2 kg

$$\begin{aligned}
 &12 + 2 + 4 + 5 + 2 \\
 &= 25 \\
 &= 25 \div 5 \\
 &= 5 \text{ kg}
 \end{aligned}$$

So we need to divide 25 by 5 to get the average, because we have five days.

There are three different types of average: the mean, the median and the mode. We are calculating the mean here.



To first put the numbers in order of size makes it easier to work out the average.

Calculate the average (mean) of the following:

- 25, 15, 20, 9, 11 and 10
- 50, 1 000, 250, 350, 100, 500, 200, 700, 600, and 300
- 1,5; 2,7 and 4,2
- 36, 40, 80 and 100
- 21, 70, 35, 14, 63, 77 and 28

After calculating the averages, say which numbers are above and which are below the mean.

Example: recycling material example above
5 kg was the average for the week.

- Monday was above the average for the week
- Tuesday, Wednesday and Friday were below the average for this week.

1. Use the tables to answer the questions.

a.

Amount of glass collected				
Week 1	Week 2	Week 3	Week 4	Week 5
5 kg	4 kg	5 kg	6 kg	5 kg

- What is the mean score? _____
- What is the median score? _____
- What is the mode? _____

b.

Amount of plastic collected						
Week 1	Week 2	Week 3	Week 4	Week 5	Week 6	Week 7
8 kg	7 kg	6 kg	4 kg	7 kg	7 kg	5 kg

- i. What is the mean score? _____
- ii. What is the median score? _____
- iii. What is the mode? _____

c.

Amount of metal collected				
Week 1	Week 2	Week 3	Week 4	Week 5
5 kg	6 kg	6 kg	5 kg	5 kg

- i. What is the mean score? _____
- ii. What is the median score? _____
- iii. What is the mode? _____

2. Here are the heights of some of the recycling bins.

135 cm, 145 cm, 125 cm, 135 cm, 145 cm, 145 cm, 125 cm, 120 cm, 120 cm, 130 cm and 115 cm.

- i. What is the mean score? _____
- ii. What is the median score? _____

3. Here is the total amount of paper collected in seven weeks.

Amount of paper collected						
Day 1	Day 2	Day 3	Day 4	Day 5	Day 6	Day 7
7 kg	6 kg	7 kg	6 kg	6 kg	7 kg	6 kg

- i. What is the mean score? _____
- ii. What is the median score? _____

4. Go back to Question 1 and work out how many kilograms of each material were collected.

Sign:

Date:

4

- Add 4 to the number.
- Add 4 more.
- Add 4 more.
- Continue with this pattern.

4

- Multiply the number by 4.
- Multiply the number by 4 again.
- Multiply the number by 4 again.
- Continue with this pattern.

1. Look at the number sequence 125, 250, 375, 500.

a. What is the difference between the numbers. _____

b. Describe the pattern. _____

2. Look at the number sequence 8, 24, 72.

a. What is the difference between the numbers. _____

b. Describe the pattern. _____

3. Give the next three numbers of the sequence. Describe the pattern.

a.

286	311	336			
-----	-----	-----	--	--	--

--	--	--	--	--	--

b.

538	547	556			
-----	-----	-----	--	--	--

c.

729	629	529			
-----	-----	-----	--	--	--

d.

347	354	361			
-----	-----	-----	--	--	--

4. Complete the pattern.

- a. 373, 374, 376, _____, _____, _____
- b. 650, 653, 659, _____, _____, _____
- c. 298, 303, 313, _____, _____, _____
- d. 642, 644, 648, _____, _____, _____
- e. 589, 593, 601, _____, _____, _____
- f. 461, 467, 479, _____, _____, _____

Collecting shells

James collects shells. Every day he picks up twice as many shells as the previous day. On the first day he picks up 7 shells. On the second day he picks up 14. How many shells would he collect on the ninth day?

Sign: _____

Date: _____

- What will the next number be?
- How did you work it out?
- What would the rule be?

5	10	15	20	25	30	35	40	45
6	12	18	24	30	36	42	48	45
7	14	21	28	35	42	49	56	63

1. Answer these questions.

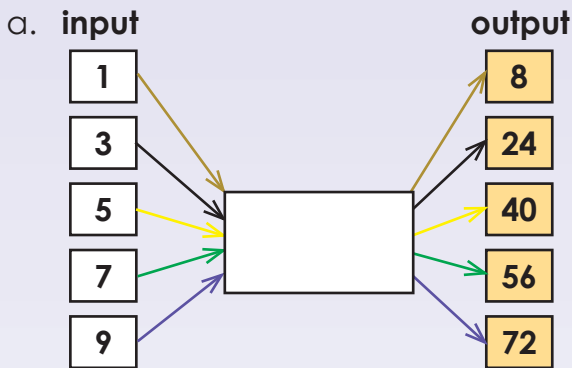

i) What would you write in the empty box?

ii) What do we call it?

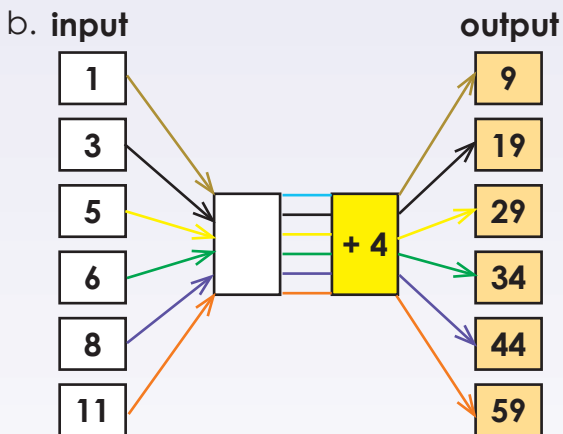

i) What would you write in the empty box?

ii) What do we call it?

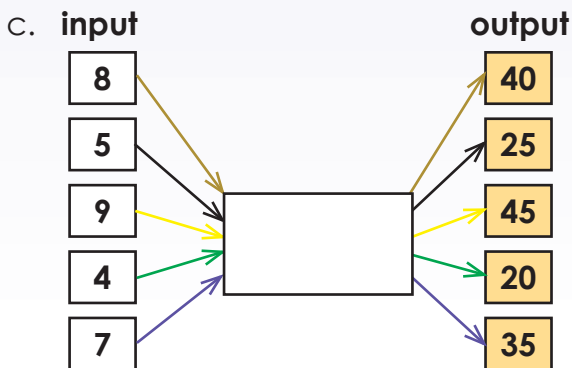

i) What would you write in the empty box?

ii) What do we call it?

2. Create your own flow diagram and describe it.

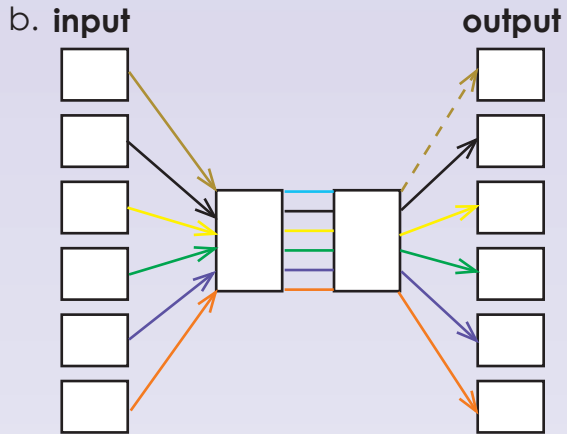

3. Determine the rule and then write a number sentence for each.

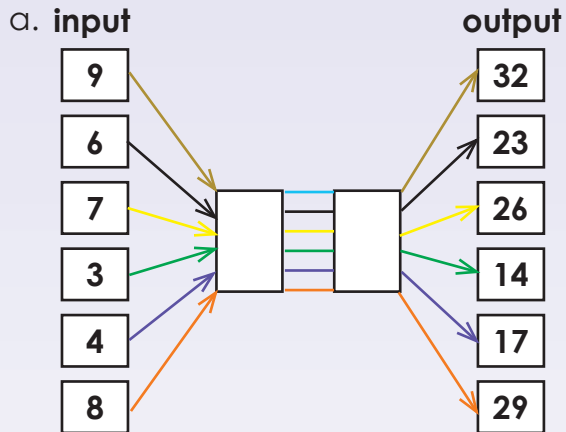

- i. $9 \square \square = 32$
- ii. $6 \square \square = 23$
- iii. $7 \square \square = 26$
- iv. $3 \square \square = 14$
- v. $4 \square \square = 17$
- vi. $4 \square \square = 29$

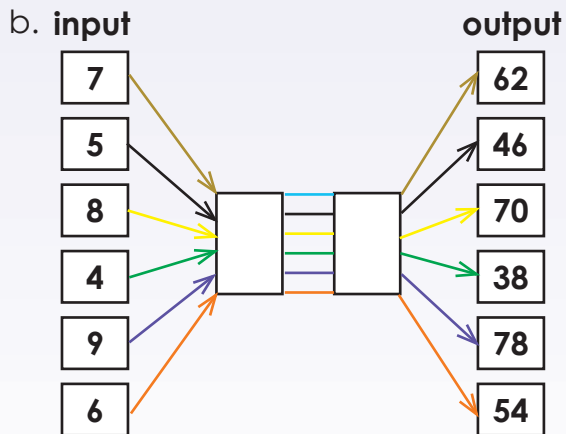

- i. _____
- ii. _____
- iii. _____
- iv. _____
- v. _____
- vi. _____

Sign:

Date:

continued

Revise measuring instruments by saying what you will use these measurement instruments for.

Measuring tape



Tape measure



Ruler



Trundle wheel



Metre stick

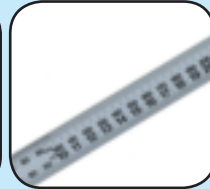

Odometre



Term 3

1. What would you use to measure the following with? Give 5 examples and in what unit you will measure.

a. I will measure in ___ and ___.



- i. _____
- ii. _____
- iii. _____
- iv. _____
- v. _____

b. I will measure in ___ and ___.



- i. _____
- ii. _____
- iii. _____
- iv. _____
- v. _____

b. I will measure in ___ and ___.

- i. _____
- ii. _____
- iii. _____
- iv. _____
- v. _____



d. I will measure in ___ and ___.



- i. _____
- ii. _____
- iii. _____
- iv. _____
- v. _____

e. I will measure in ___ and ___.



- i. _____
- ii. _____
- iii. _____
- iv. _____
- v. _____

f. I will measure in ___ and ___.



- i. _____
- ii. _____
- iii. _____
- iv. _____
- v. _____

3. Draw the following lines with your ruler.

a. 9 cm

b. 6,3 cm

c. 142 mm

Create a ruler

Draw a 10 cm ruler with its divisions.



Sign: _____
Date: _____

- Show 98 mm on the ruler.
- Show where it says cm.
- How many cm is it?



We can sometimes record measurements in centimetres and fractions of centimetres, e.g. the eraser is $2\frac{1}{2}$ cm long. This is easy to do because on a ruler, the fifth millimetre gradation line is normally longer. Once you have learnt, from reading commercial mass and capacity packaging, that $2\frac{1}{2}$ is the same as 2,5, you will also be able to use the decimal, 5 in your recording, i.e. 2,5 cm long.

1. First do the practical activity and then write the following in cm and mm and then cm only.

Show 65 mm on the ruler.



Example: 65 mm = 6 cm and 5 mm or $6\frac{1}{2}$ cm or 6,5 cm

- | | |
|------------------|------------------|
| a. 98 mm = _____ | b. 57 mm = _____ |
| c. 74 mm = _____ | d. 66 mm = _____ |
| e. 85 mm = _____ | f. 49 mm = _____ |

2. Write the following as mm.

Show $9\frac{1}{2}$ cm on the ruler.



Example: $9\frac{1}{2}$ cm or 9 cm and 5 mm = 95 mm

- | | |
|------------------------------|------------------------------|
| a. $9\frac{1}{2}$ cm = _____ | b. $5\frac{1}{2}$ cm = _____ |
| c. $7\frac{1}{2}$ cm = _____ | d. $4\frac{1}{2}$ cm = _____ |
| e. $8\frac{1}{2}$ cm = _____ | f. $6\frac{1}{2}$ cm = _____ |

3. Write the following in m and cm.

Example: 786 cm = 7 m and 86 cm

Show 786 cm on a tape measure.



a. 963 cm

b. 698 cm

c. 741 cm

d. 587 cm

e. 852 cm

f. 479 cm

4. Write the following in cm.

Example: 9 m and 75 cm = 975 cm

Show 9 m and 75 cm on a tape measure.



a. 9 m and 73 cm

b. 7 m and 58 cm

c. 6 m and 91 cm

d. 4 m and 89 cm

e. 8 m and 62 cm

f. 5 m and 47 cm

continued

Sign: _____

Date: _____



Converting between lengths continued



Term 1

5. Write the following in m and cm

Example: 3 650 cm = 36 m and 50 cm or 36,5 m

Show 3 650 cm on a long tape measure.



a. 6 260 cm

b. 7 590 cm

c. 3 920 cm

d. 9 100 cm

e. 8 450 cm

f. 4 220 cm

6. Write the following in m.

Example: 6 m and 400 cm = 6 400 m

Show 6 m and 400 cm on a tape measure.



a. 7 m and 300 cm

b. 6 m and 200 cm

c. 8 m and 500 cm

d. 9 m and 400 cm

e. 3 m and 200 cm

f. 4 m and 100 cm

7. Write the following as m.

Example: $5\frac{1}{2}$ km = 5 500 m

Show $5\frac{1}{2}$ km on an odometer² (trip meter).

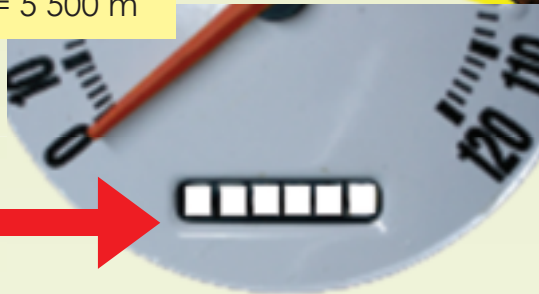

a. $9\frac{1}{2}$ km _____

b. $6\frac{1}{2}$ km _____

c. $7\frac{1}{2}$ km _____

d. $4\frac{1}{2}$ km _____

e. $8\frac{1}{2}$ km _____

f. $5\frac{1}{2}$ km _____

8. Write the following as km.

Example: 6 500 m = $6\frac{1}{2}$ km or 6,5 km

Show 6 500 m on the odometer.



a. 1 400 m _____

b. 3 900 m _____

c. 7 500 m _____

d. 2 800 m _____

e. 8 600 m _____

f. 9 700 m _____

Who travelled further?

Our friends travelled 3,5 km to the event. We travelled 3 250 m to the event. Who travelled the farthest?

Sign:

Date:

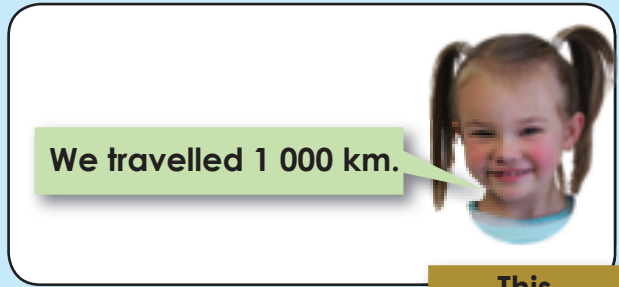

This represents 10 mm or 1 cm.

1. Round off to the nearest cm. Draw the arrows on the number lines.

Example: a. 3 mm rounded off is 0 mm, 6 mm rounded off is 1 cm

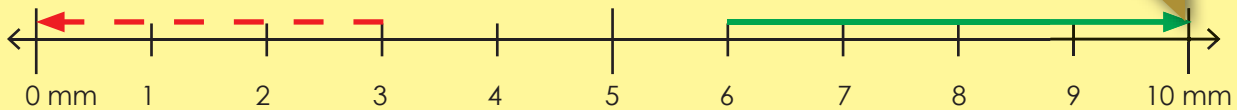

a. 14 mm rounded off is _____ 16 mm rounded off is _____

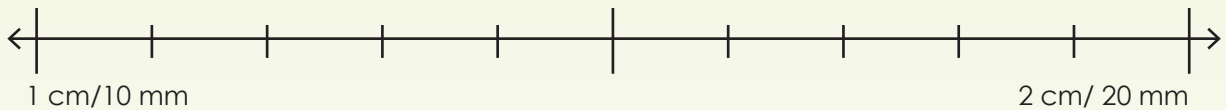

b. 44 rounded off is _____ 45 rounded off is _____

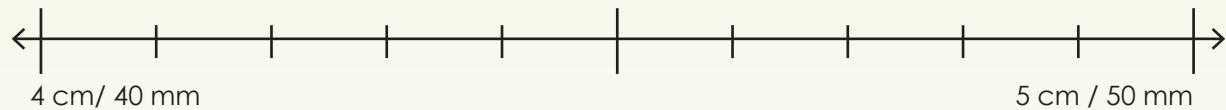

c. 189 rounded off is _____ 182 rounded off is _____

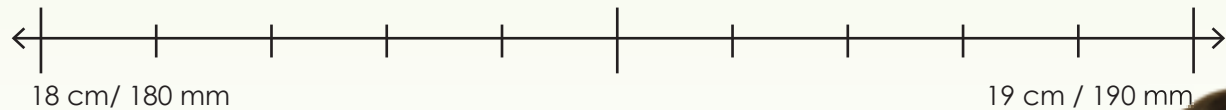

2. Round off to the nearest m.

What does each interval represent?

Example: a. 30 cm rounded off is 0 m, 90 cm rounded off is 1 m

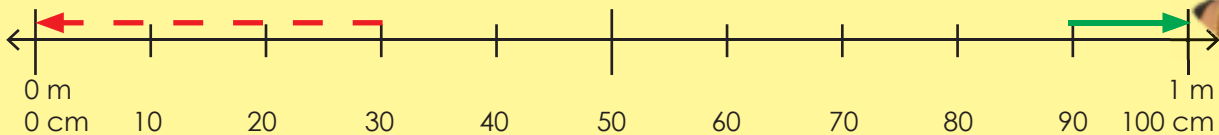

Term 3

a. 645 cm rounded off is _____ 655 cm rounded off is _____

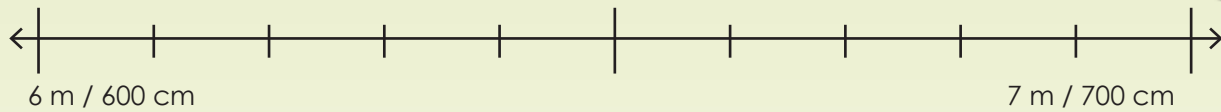

b. 845 cm rounded off is _____ 874 cm rounded off is _____

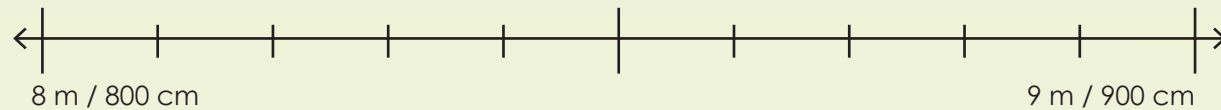

c. 335 cm rounded off is _____ 365 cm rounded off is _____

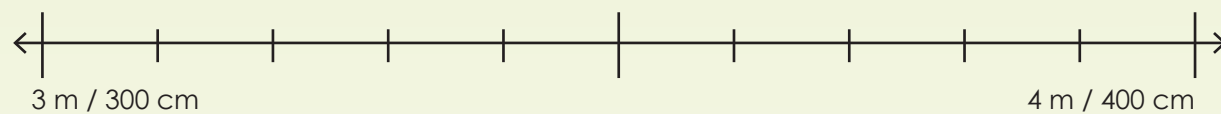

3. Round off to the nearest m.

Example: a. 400 rounded off is 0, 800 rounded off is 1



a. 6 400 mm rounded off is _____ 6 600 mm rounded off is _____

b. 8 100 mm rounded off is _____ 8 600 mm rounded off is _____

c. 5 400 mm rounded off is _____ 6 900 mm rounded off is _____

4. Round off to the nearest km.

Example:

Round off to km. To round off 1 km and 750 m using your knowledge of rounding off to thousand. 2 km and 650 m \approx 3 km.

a. 3 km and 230 m _____ b. 6 km and 520 m _____

c. 7 km and 150 m _____ d. 9 km and 610 m _____

e. 2 km and 470 m _____ f. 4 km and 460 m _____

g. 3 km and 380 m _____ h. 8 km and 740 m _____

i. 5 km and 890 m _____

Rounding off is easy

Why is it easier to work of with a rounded quantity? Give an example.

Sign: _____
Date: _____

Look at the fraction board and add...



- $\frac{1}{2}$ and $\frac{1}{2} = 1$ whole
- $\frac{1}{4}$ and $\frac{1}{4} = \frac{1}{2}$
- $\frac{1}{4} + \frac{1}{4} + \frac{1}{4} + \frac{1}{4} = 1$ whole

We are going to add, subtract, multiply and divide with length.



Term 3

1. First work through these examples and then solve the problems

Example 1:

I bought 4 200 mm and then 3 300 mm of string. How much string did I buy? Write down your answer in mm and cm and then in m.

$$\begin{aligned} &4\ 200\ \text{mm} + 3\ 300\ \text{mm} \\ &= 4\ 000\ \text{mm} + 3\ 000\ \text{mm} + 200\ \text{mm} + 300\ \text{mm} \\ &= 7\ 000\ \text{mm} + 500\ \text{mm} \\ &= 7\ 500\ \text{mm} \end{aligned}$$

m and cm : 7 m 500 mm
Metres: $7\frac{1}{2}$ m

Example 2:

I bought $7\frac{1}{2}$ m of ribbon. I used $3\frac{1}{2}$ m. How much ribbon do I have left? Make a drawing.

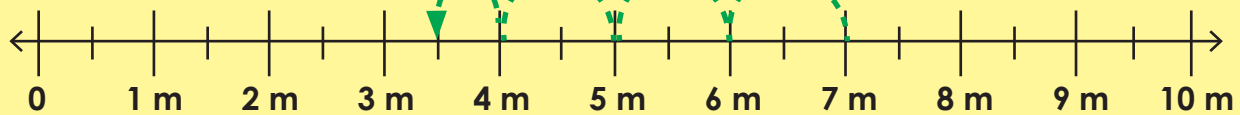

$3\frac{1}{2}$ metres of ribbon are left.

Example 3:

We travelled 530 km 500 m on the first day. Our holiday destination is 1 000 km from home. How far should we still travel?

$$\begin{aligned} &1\ 000\ \text{km} - (530\ \text{km}\ 500\ \text{m}) \\ &= 470\ \text{km} - 500\ \text{m} \\ &= 469\ \text{km}\ 500\ \text{m}\ \text{or}\ 469,5\ \text{km} \end{aligned}$$

- a. I bought 4 600 mm of string and then 2 800 mm more. How much string did I buy? Write down your answer in mm and cm, and then in m.

- b. I bought 9 m of ribbon. I used $3\frac{1}{2}$ m. How much ribbon do I have left? Write your answer in m.

- c. My father's desk is 3 300 mm long and mine measures 6 200 mm. How much longer is my desk than my father's desk? Write down your answer in m and cm, and then in m.

- d. I bought 90 m of wool. I used $19\frac{1}{2}$ m. How much wool do I have left? Write your answer in m.

- e. Sandra and Sipho travelled 1 520 km. Sandra drove 579 km. How far did Sipho drive?

- f. My car has to go for a service in 2 871 km. I drove 1 264 km during the month. How many kilometres before I have to take my car for the service?

Sign:

Date:

Kilometres

103

What is a kilometre?

Find out what a kilometre is.

How many times should you go around a soccer field to make one kilometre?

About how many big adult steps will make a kilometre?

How many times should you go around a netball court to make one kilometre?

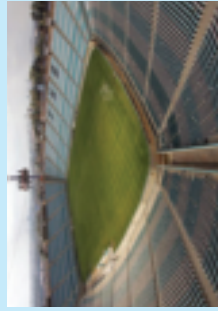

1. Extend the number lines below. What do you notice?

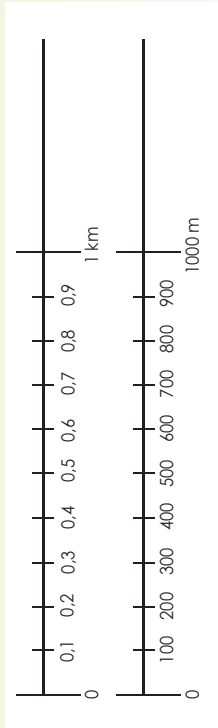

2. Complete the table below by estimating and measuring.

	Estimate	Measure
Length of the classroom		
Distance from your home to school		
Distance from your classroom to Grade 1 classroom		

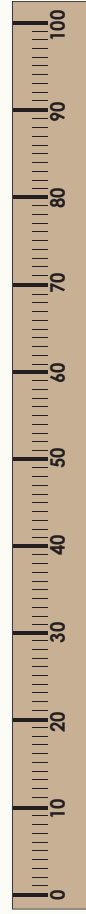

3. Convert the following:

a. 3 000 m = km

b. 200 m = km

c. 4 500 m = km

d. 350 m = km

e. 2 876 m = km

f. 420 m = km

4. What unit will you use when measuring each of the following?

- a. Pencil
- b. Book
- c. Length of netball court
- d. Distance from Durban to Johannesburg
- e. Eraser
- f. Desk

Revise: What is a kilometre?

1. How far do you think it is from:

- a. Johannesburg to Cape Town?
- b. Pretoria to Johannesburg?
- c. Your town or city to Johannesburg?
- d. Your town or city to Durban?
- e. Your town or city to Cape Town?

2. Look at the distance chart below to complete the table on the next page:

Beaufort West	535	Bloemfontein	463	998	Cape Town	316	219	779	Colesburg	1225	667	1660	881	Durban	597	575	1042	518	667	East London	237	764	436	545	1240	630	George - Garden Route	951	417	1405	623	598	992	1168	Johannesburg	497	175	960	284	842	750	734	467	Kimberley	1386	854	1886	1058	774	1308	1603	465	939	Komatiipoort	273	808	392	608	1306	696	66	1234	770	1669	Mossel Bay	1293	771	1770	964	689	1214	1509	358	832	87	1575	Neispruit - Southern Kruger gate	179	714	422	495	1244	689	63	1130	676	1565	94	1472	Oudtshoorn	1486	952	1940	1158	910	1391	1686	535	1009	308	1726	221	1391	Phalaborwa - Northern Kruger Gate	405	635	756	454	927	300	330	1062	752	1484	396	1373	358	1524	Perf Elizabeth	1009	475	1463	681	656	1050	1226	58	532	429	1292	342	1188	477	1120	Pretoria	1402	880	1888	1073	809	1334	1616	478	952	105	1695	120	1561	222	1480	462	Skukuza - Kruger Park	440	975	49	756	1594	1070	392	1391	937	1826	363	1733	399	1866	739	1449	1842	Stellenbosch	1656	1890	1469	1772	2557	2280	1761	2189	1715	2545	1797	2458	1703	2617	2077	2116	2578	1462	Windhoek
---------------	-----	--------------	-----	-----	-----------	-----	-----	-----	-----------	------	-----	------	-----	--------	-----	-----	------	-----	-----	-------------	-----	-----	-----	-----	------	-----	-----------------------	-----	-----	------	-----	-----	-----	------	--------------	-----	-----	-----	-----	-----	-----	-----	-----	-----------	------	-----	------	------	-----	------	------	-----	-----	--------------	-----	-----	-----	-----	------	-----	----	------	-----	------	------------	------	-----	------	-----	-----	------	------	-----	-----	----	------	----------------------------------	-----	-----	-----	-----	------	-----	----	------	-----	------	----	------	------------	------	-----	------	------	-----	------	------	-----	------	-----	------	-----	------	-----------------------------------	-----	-----	-----	-----	-----	-----	-----	------	-----	------	-----	------	-----	------	----------------	------	-----	------	-----	-----	------	------	----	-----	-----	------	-----	------	-----	------	----------	------	-----	------	------	-----	------	------	-----	-----	-----	------	-----	------	-----	------	-----	-----------------------	-----	-----	----	-----	------	------	-----	------	-----	------	-----	------	-----	------	-----	------	------	--------------	------	------	------	------	------	------	------	------	------	------	------	------	------	------	------	------	------	------	----------

How far is:	km	m
a. Beaufort West is from Johannesburg?	951 km	951 000 m
b. Durban from Johannesburg?		
c. Kimberley from Cape Town?		
d. Mossel Bay from Pretoria?		
e. East London from Cape Town?		
f. Komatiipoort from Oudtshoorn?		
g. Phalaborwa from Johannesburg?		
h. Stellenbosch from Pretoria?		
i. Stellenbosch from Cape Town?		
j. Neispruit from Pretoria?		
k. Windhoek from Johannesburg?		

Kilometre outing



Your teacher will take you on a kilometre outing.

You will be divided into 5 groups.

Each group will guess what (place, landmark, etc.) is about 1 km from the school.

The group whose guess is the closest is the winning group.

Numbers 0 – 1 000 000

105a

What is a million? Look at all the pictures, numbers and words.

- 1 000 000
- A million seconds is 12 days.
- Million sided shape is a hecatommyriagon.
- 1 000 000 mm = 1 km
- R1 000 000
- A million minutes is 1 year, 329 days, 10 hours and 40 minutes.
- Six zillion

1. Say if the following is true or false:

- a. There are 1 000 000 millimetres in 1 kilometre.
- b. There are 1 000 000 metres in 1 kilometre.
- c. There are 1 000 000 grams in 1 ton.
- d. There are 1 000 000 millilitres in 1 litre.
- e. There are 1 000 000 millilitres in 1 000 litres.

2. Complete the following:

- a. $1\ 000\ 000 + 500\ 000 + 70\ 000 + 8\ 000 + 400 + 90 + 6 =$
- b. $1\ 000\ 000 + 300\ 000 + 40\ 000 + 9\ 000 + 500 + 1 =$
- c. $1\ 000\ 000\ 000 + 900\ 000 + 50 =$
- d. $1\ 000\ 000 + 3 =$
- e. $300 + 800\ 000 + 9 + 50\ 000 + 1\ 000\ 000 + 40 + 2\ 000 =$

3. What is the place value of the underlined digits in each number?

- a. 1 389 532 =
- b. 1 763 949 =
- c. 10 902 482 =
- d. 100 002 005 =
- e. 1 999 999 999 =

4. Circle the number that is:

- a. 200 000 more than 1 547 893: 1 567 893, 1 547 895, 1 747 893, 1 569 893
- b. 50 000 more than 2 732 410: 2 732 415, 2 782 425, 2 787 425, 2 782 410
- c. 4 000 more than 35 185 432: 35 189 432, 35 185 932, 35 185 437, 35 185 932
- d. 300 000 more than 231 365 464: 231 365 764, 231 368 464, 231 665 464
- e. 1 000 000 more than 2 786 453: 2 886 453, 3 786 453, 2 886 453, 1 796 453

5. Use any digits to make five different 9-digit numbers smaller than 999 999 999 but bigger than 500 000 000.

a.

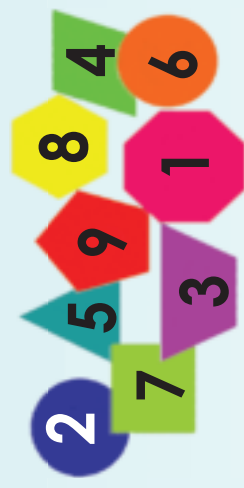

6. Answer <, > or =

- a. 1 893 349 1 983 349
- b. 2 454 390 2 450 309
- c. 3 300 900 3 003 900
- d. 99 999 909 99 999 009
- e. 6 404 080 6 040 808

7. Write the following in numbers:

- a. One million six hundred and thirty two thousand five hundred and eighty one.
- b. Two hundred and twenty five thousand four hundred and eleven.

8. Write the following in words:

- a. 1 568 700
- b. 2 701 298
- c. 17 876 305
- d. 34 984 534

Page:
 Date:

9. Answer the following questions:

- a. What is a prime number?
- b. Give 5 prime numbers bigger than 10 but smaller than 100?
- c. What is a composite number?
- d. Give 5 composite numbers bigger than 10 but smaller than 100?

10. Round the numbers off to the nearest 10:

- a. 18
- b. 21
- c. 376
- d. 1 282
- e. 45 693
- f. 187 008
- g. 2 345 999
- h. 68 483 704

11. What number do you see to round off to the nearest 5?

	ten	hundred	thousand
a.	92		
b.	348		
c.	2 871		
d.	5 908		
e.	47 610		
f.	989 898		
g.	1 707 078		
h.	29 999 999		

13. A production manager needs to have an estimate of how many items his factory produces per week. He normally rounds off the tallies and then adds them. The tallies are as follows: 4 232 145 ; 5 468 099 ; 8 000 892.

- a. Round off these tallies to the nearest 10 and then add them.
- b. Round off these tallies to the nearest 100 and then add them.
- c. Round off these tallies to the nearest 1 000 and then add them.
- d. Which of the above answers is the most accurate? Give a reason for your answer.



Really big numbers



Is this the same in South Africa?

- Million: 1 000 000
- Billion: 1 000 000 000
- Trillion: 1 000 000 000 000
- Quintillion: 1 000 000 000 000 000 000
- Sextillion: 1 000 000 000 000 000 000 000
- Nonillion: 1 000 000 000 000 000 000 000 000 000 000
- Centillion: 1 followed by 303 zeros

Multiplication: more 3-digit by 3-digit

What number comes next?

2	6	18	54	?
20	60	180	540	?
200	600	1 800	5 400	?
2 000	6 000	18 000	54 000	?

Try this!

2	5	25	125	?
10	50	250	1250	?
100	500	2 500	12 500	?
1 000	5 000	25 000	12 5000	?

What if I start with 20 000?



1. Complete the table below.

Number	x 100	x 200	x 300	x 400	x 500	x 600	x 700	x 800	x 900
100									
150									
200									
250									
350									

2. Use both methods to do the sums below.

Examples:
Example 1:

$$\begin{array}{r} 543 \\ \times 798 \\ \hline 24 \\ 270 \\ 2100 \\ 320 \\ 3600 \\ 28000 \\ 4000 \\ 45000 \\ + 350000 \\ \hline 433314 \end{array}$$

- (3 x 8)
- (3 x 90)
- (3 x 700)
- (40 x 8)
- (40 x 90)
- (40 x 700)
- (500 x 8)
- (500 x 90)
- (500 x 700)

Check your answer using a calculator

Example 2:

$$\begin{array}{r} 543 \\ \times 798 \\ \hline 4344 \\ 48870 \\ + 380100 \\ \hline 433314 \end{array}$$

a. $678 \times 324 =$

b. $795 \times 382 =$

Check your answer using a calculator. Mark your answer. Continue on an extra sheet of paper.

c. $849 \times 473 =$

d. $699 \times 399 =$

You did 3-digit x 3-digit before but this time your answer will be bigger than 200 000 and smaller than 500 000. See if this is true!!



Check your answer using a calculator. Mark your answer. Continue on an extra sheet of paper.

e. $938 \times 525 =$

Check your answer using a calculator. Mark your answer. Continue on an extra sheet of paper.

continued

3. Solve the problems.

- a. A leaking tap drips 5 ml every minute. How many litres of water will be wasted in a week?

Check your answer using a calculator. Mark your answer. Continue on an extra sheet of paper.

- b. This morning, at O.R. Tambo airport, 34 aeroplanes landed with 327 people in each plane. How many people landed at the airport this morning?

Check your answer using a calculator. Mark your answer. Continue on an extra sheet of paper.

- c. On an apple farm there are 999 apple trees. If there are 73 apples in each tree, how many apples will there be?

Check your answer using a calculator. Mark your answer. Continue on an extra sheet of paper.

Using all the digits

The following multiplication sum uses every digit from 0 to 9 once (not counting the intermediate steps).

Fill in the missing numbers.

7

□

□

=

□

□

□

Describe what you see?

2	4	6	8	10	12	14	16	18	20
3	6	9	12	15	18	21	24	27	30
4	8	12	16	20	24	28	32	36	40
5	10	15	20	25	30	35	40	45	50

When you list the multiples of two (or more) numbers, and find the same number in both, then that is a **common multiple** of those numbers.

1. Write down the multiples for the following numbers, and circle the common multiples for the two numbers.

- a. 2 _____
- 6 _____
- b. 3 _____
- 9 _____
- c. 4 _____
- 7 _____
- d. 5 _____
- 8 _____
- e. 10 _____
- 12 _____

2. Look at the examples above. What is the smallest common multiple for the following?

2 and 6	
3 and 9	
4 and 7	
5 and 8	
10 and 12	

The smallest common multiple is called the **lowest common multiple**.

The smallest common multiple for 2 and 6 is 6.



3. Use the example to complete the number lines below.

Multiples of 3

3 → 6 → 9 → 12 → 15 → 18

0 1 2 3 4 5 6 7 8 9 10 11 12 13 14 15 16 17 18 19 20

Multiples of 5

5 → 10 → 15 → 20

- a. Multiples of 2 and 4.
- b. Multiples of 3 and 6.
- c. Multiples of 2 and 8.
- d. Multiples of 3 and 4.
- e. Multiples of 2 and 7.

Match the puzzle

Match a black puzzle piece with an orange piece.

LCM for 7 and 6	LCM for 9 and 7	24	63
LCM for 8 and 4	LCM for 6 and 8	42	8

Multiplication: 4-digit by 3-digit

What number comes next? Try this!

5	25	125	625	?
10	100	1 000	10 000	?
1	4	16	64	?
7 000	21 000	63 000	189 000	?

1. Complete the table below:

Number	x 1 000	x 2 000	x 3 000	x 4 000	x 5 000
600					
650					
700					
750					
800					

3. Calculate the following:

- a. $456 \times 78 =$
- b. $785 \times 364 =$

Check your answer using a calculator. Mark your answer. Continue on an extra sheet of paper

- c. $8\,375 \times 66 =$
- d. $7\,923 \times 567 =$

Check your answer using a calculator. Mark your answer. Continue on an extra sheet of paper

3. Solve the problems.

- a. 39 aeroplanes were chartered to bring tourists from Europe to South Africa. Each plane can carry 345 passengers. How many people in total can be carried by 39 aeroplanes? Show all your calculations.

Check your answer using a calculator. Mark your answer. Continue on an extra sheet of paper

- b. Green Point Football Stadium is divided into 124 stands. Each stand can seat 544 people. How many people can be seated in total? Show all your calculations.

Check your answer using a calculator. Mark your answer. Continue on an extra sheet of paper

- c. On the chicken farm, 2 391 eggs are laid every day of the year. How many eggs are laid in a year?

Check your answer using a calculator. Mark your answer. Continue on an extra sheet of paper

Using all the digits

Fill in the missing numbers. Use the numbers 1 to 9 to complete the sums. Each number is only used once. Each row is a math sum. Remember that multiplication and division are performed before addition and subtraction.

x		+		9
-	x		+	
	x	-		18
x		-		41
-70	-1	+		8

Answers that are -70 and -1! I am sure somebody will help me!!

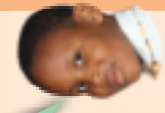

Page: _____
Date: _____

110a Multiplication and rounding off

Revise: What do you notice in each block?

Round the numbers off to the nearest 10.

- $7 \approx 10$
- $31 \approx 30$
- $617 \approx 620$
- $2\ 532 \approx 2\ 530$

Round the numbers off to the nearest 100.

- $83 \approx 100$
- $739 \approx 700$
- $421 \approx 400$
- $6\ 735 \approx 6\ 700$

Round the numbers off to the nearest 1 000.

- $476 \approx 0$
- $502 \approx 1\ 000$
- $3\ 509 \approx 4\ 000$
- $6\ 329 \approx 6\ 000$

1. Round the numbers off to the nearest 10, 100 and 1 000.

	Nearest 10	Nearest 100	Nearest 1 000
a. 3 879			
b. 9 304			
c. 4 673			
d. 2 214			
e. 2 387			

2. Multiply the numbers by rounding off the first number (multiplier) to the nearest 1 000 and the second number (multiplicand) to the nearest 100.



Why do you think we sometimes round off numbers before we multiply them?

Example 1:
 $3\ 353 \times 104$
 $\approx 3\ 000 \times 100$
 $\approx 300\ 000$

a. $9\ 317 \times 687 =$

Continue on an extra sheet of paper.

b. $2\ 863 \times 239 =$

Continue on an extra sheet of paper.

c. $5\ 794 \times 314 =$

Continue on an extra sheet of paper.

d. $6\ 485 \times 524 =$

Continue on an extra sheet of paper.

3. Multiply the numbers by rounding off the first number (multiplier) to the nearest 100.

Example 1:
 $3\ 353 \times 104$
 $\approx 4\ 000 \times 104$
 $\approx (4\ 000 \times 100) + (4\ 000 \times 4)$
 $\approx 300\ 000 + 16\ 000$
 $\approx 316\ 000$

a. $9\ 517 \times 535 =$

Continue on an extra sheet of paper.

b. $6\ 485 \times 187 =$

Continue on an extra sheet of paper.

c. $7\ 204 \times 684 =$

Continue on an extra sheet of paper.

d. $8\ 396 \times 579 =$

Continue on an extra sheet of paper.

Multiplication and rounding off continued

110b

4. Multiply the numbers by rounding off the second number (multiplicand) to the nearest 100.

a. $6\,572 \times 209 =$

Continue on an extra sheet of paper.

c. $9\,365 \times 545 =$

Continue on an extra sheet of paper.

b. $7\,436 \times 689 =$

Continue on an extra sheet of paper.

d. $8\,274 \times 374 =$

Continue on an extra sheet of paper.

5. Multiplying the numbers by rounding off the first number (multiplier) and the second number (multiplicand) to the nearest 100.

a. $7\,697 \times 863 =$

Continue on an extra sheet of paper.

b. $6\,427 \times 478 =$

Continue on an extra sheet of paper.

c. $5\,853 \times 822 =$

Continue on an extra sheet of paper.

d. $4\,634 \times 246 =$

Continue on an extra sheet of paper.

6. Go back to question 2-5. Check to see how close your answer were by multiplying the numbers with a calculator.

7. Estimate what the answers will be. Calculate and then check your calculation against your estimation.

a. $35\,421 + 42\,365 =$

b. $4\,235 \times 76 =$

Birthday money

My mother sells birthday hampers. In each hamper is chocolate worth R25, candy worth R22 and toffees worth R18. The box for the sweets costs R5. My mother adds another R20 for making it and for her delivery cost. She sold R2 320 worth of hampers last year. What was the total amount of money my mother received?

Multiplication and the distributive property

Revise the distributive property.

$$6 \times (5 + 3) = (6 \times 5) + (6 \times 3)$$

$$6 \times 8 = 30 + 18$$

$$48 = 48$$

Method 1:

$$(4 + 6) \times (5 + 7)$$

$$= (4 \times 5) + (4 \times 7) + (6 \times 5) + (6 \times 7)$$

$$= 20 + 28 + 30 + 42$$

$$= 120$$

OR

$$\begin{array}{r} \text{Method 2:} \\ \times \quad 5 \quad 7 \\ 4 \quad 20 \quad 28 \\ 6 \quad 30 \quad 42 \\ \hline 20 + 28 + 30 + 42 \\ = 120 \end{array}$$

1. Calculate the following using both methods above.

a. $(9 + 5) \times (2 + 9)$

Method 1

Method 2

b. $(7 + 3) \times (8 + 2)$

Method 1

Method 2

2. Calculate the following using the example to guide you.

Example:

$$2\,643 \times 45$$

$$= (2\,000 + 600 + 40 + 3) \times (40 + 5)$$

$$= (80\,000 + 10\,000 + 24\,000 + 3\,000 + 1\,600 + 200 + 120 + 15)$$

$$= 80\,000 + 10\,000 + 20\,000 + 4\,000 + 3\,000 + 1\,000 + 600 + 200 + 100 + 20 + 10 + 5$$

$$= 110\,000 + 8\,000 + 900 + 30 + 5$$

$$= 100\,000 + 10\,000 + 8\,000 + 900 + 30 + 5 = 118\,935$$

x	40	5	
2000	80 000	10 000	90 000
600	24 000	3 000	27 000
40	1 600	200	1 800
3	120	15	135
			118 935

a. $2\,367 \times 858$

Method 1

Method 2

b. $3\,485 \times 476$

Method 1

Method 2

3. Calculate the following using the example to guide you.

Example:

$$2\,643 \times (50 - 5)$$

$$= (2\,000 + 600 + 40 + 3) \times (50 - 5)$$

$$= (10\,000 - 10\,000) + (30\,000 - 3\,000) + (2\,000 - 200) + (150 - 15)$$

$$= 90\,000 + 27\,000 + 1\,800 + 135$$

$$= 90\,000 + 20\,000 + 7\,000 + 1\,000 + 800 + 100 + 30 + 5$$

$$= 110\,000 + 8\,000 + 900 + 30 + 5$$

$$= 100\,000 + 10\,000 + 8\,000 + 900 + 30 + 5$$

$$= 118\,935$$

a. $2\,593 \times (200 - 44)$

b. $3\,415 \times (400 - 66)$

Boots and all

- a. This year a company gave 6 273 boxes of soccer balls to children. Each box had 45 soccer balls. How many soccer balls did the company give away?
 b. A company bought 556 new laptops for R4 750.00 each. How much did they pay in total?

112a Multiplication and the vertical method

Revise

Expanded notation:

- $456 = 400 + 50 + 6$
- $908 = 900 + 0 + 8$ or $900 + 8$
- $2\,215 = 2\,000 + 200 + 10 + 5$
- $4\,086 = 4\,000 + 80 + 6$

1. Write the following in expanded notation.

Example: $456 = 400 + 50 + 6$

- a. 678 _____
- b. 937 _____
- c. 1735 _____
- d. 1 753 _____
- e. 2 583 _____
- f. 4 987 _____
- g. 5 383 _____
- h. 9 364 _____

2. Calculate the following.

Example:
 $5 \times 2\,847$
 $= 5 \times (2\,000 + 800 + 40 + 7)$
 $= 10\,000 + 4\,000 + 200 + 35$
 $= 14\,235$

a. 8×284

b. $7 \times 9\,873$

3. Calculate the following.

Example:

$$\begin{array}{r} 2\,163 \\ \times \quad 14 \\ \hline 8\,652 \\ 42\,163 \\ \hline 30\,282 \end{array}$$

$$\begin{aligned} & \xrightarrow{4 \times 2\,163} \\ &= 4 \times (2\,000 + 100 + 60 + 3) \\ &= 8\,000 + 400 + 240 + 12 \\ &= 8\,652 \\ &+ 21\,630 \xrightarrow{10 \times 2\,163} \\ &= 21\,630 \end{aligned}$$

a. 937×32

b. $7\,843 \times 96$

4. Calculate the following.

Example: $3\,432 \times 26$

$$\begin{array}{r} 3\,432 \\ \times \quad 26 \\ \hline 20\,592 \\ 68\,640 \\ \hline 89\,232 \end{array}$$

$\xrightarrow{6 \times 3\,432}$
 $= 6 \times (3\,000 + 400 + 30 + 2)$
 $= 18\,000 + 2\,400 + 180 + 12$
 $= 20\,592$

$\xrightarrow{20 \times 3\,432}$
 $= 20 \times (3\,000 + 400 + 30 + 2)$
 $= 60\,000 + 8\,000 + 600 + 40$
 $= 68\,640$

a. $7\,382 \times 39$

b. $6\,928 \times 72$

Multiplication and the vertical method

continued

112b

5. Write the following in expanded notation.

Example: $1\ 638 = 1\ 000 + 600 + 30 + 8$

- a. 6 642 _____
- b. 3 545 _____
- c. 5 971 _____
- d. 1 253 _____
- e. 4 822 _____
- f. 6 987 _____

6. Calculate the following.

Example:
 $5 \times 5\ 963$
 $= 5 \times (5\ 000 + 900 + 60 + 3)$
 $= 25\ 000 + 4\ 500 + 300 + 15$
 $= 29\ 815$

- a. $7 \times 1\ 748$ _____
- b. $9 \times 8\ 115$ _____

7. Calculate the following.

Example:
 $5\ 963$
 $\times 104$
 $\hline 23\ 852$ $\rightarrow 4 \times 5\ 963$
 $= 4 \times (5\ 000 + 900 + 60 + 3)$
 $= 20\ 000 + 3\ 600 + 240 + 12$
 $= 23\ 852$
 $+ 59\ 630$ $\rightarrow 100 \times 5\ 963$
 $\hline 620\ 152$ $= 596\ 300$

a. $5\ 158 \times 270$

b. $8\ 772 \times 409$

8. Calculate the following.

Example: $6\ 439 \times 158$

$$\begin{array}{r} 6\ 439 \\ \times 158 \\ \hline 51\ 512 \\ + 321\ 950 \\ \hline 1\ 017\ 026 \end{array}$$

$\rightarrow 8 \times 6\ 439$
 $= 8 \times (6\ 000 + 400 + 30 + 9)$
 $= 48\ 000 + 3\ 200 + 240 + 72$
 $= 51\ 512$
 $\rightarrow 50 \times 6\ 439$
 $= 50 \times (6\ 000 + 400 + 30 + 9)$
 $= 300\ 000 + 20\ 000 + 1\ 500 + 450$
 $= 321\ 950$
 $\rightarrow 100 \times 6\ 439$
 $\hline 1\ 017\ 026$

a. $5\ 158 \times 270$

b. $8\ 772 \times 409$

Apples and students

- A farmer planted 3 650 apple trees in a row. He planted 135 rows. How many trees did he plant?
- 3758 students enrolled in a college. They had to pay R450 for admission fees. How much money did the students pay altogether?

Let us revise!

A ratio shows the relative sizes of two or more values. Ratios can be shown in different ways. Using the ":" to separate example values, or as a single number by dividing one value by the total. We can have "part-to-part" and "part-to-whole" ratios.

Example: Here are six numbers, some odd and some even.

Part to part: $5\ 678$ $5\ 676$ $5\ 675$ $5\ 671$ $5\ 677$ $5\ 673$

The ratio of **even numbers to odd numbers** is 2:4 or $\frac{2}{4}$

The ratio of **odd numbers to even numbers** is 4:2 or $\frac{4}{2}$

Part to whole:

The ratio of even numbers to all the numbers is 2:6 or $\frac{2}{6}$

The ratio of odd numbers to all the numbers is 4:6 or $\frac{4}{6}$

Remember that $\frac{2}{4}$ in its simplest form will be $\frac{1}{2}$

Remember that $\frac{4}{2}$ in its simplest form will be $\frac{2}{1}$ or 2

Remember that $\frac{2}{6}$ in its simplest form will be $\frac{1}{3}$

Remember that $\frac{4}{6}$ in its simplest form will be $\frac{2}{3}$

1. Write four ratios for each statement. We have done the first one for you.

a. There are 8 puppies; 6 are male, and 2 are female.

i. 6 male to 2 female (6:2) part to part

ii. 2 female to 6 male (2:6) part to part

iii. 6 male to all (6:8) part to whole

iv. 2 female to all (2:8) part to whole

b. A recipe for pancakes uses 3 cups of flour and 2 cups of milk.

i.

ii.

iii.

iv.

c. You need to make pancakes for 4 times the quantity above. Write down four new ratios.

i.

ii.

iii.

iv.

2. Read the following and discuss. Take a 4-digit number with no repeating digit. 1234. It has 24 possible combinations using each digit only once.

1234, 1243, 1324, 1342, 1432, 1423, 2134, 2143, 2314, 2341, 2413, 2431, 3124, 3142, 3214, 3241, 3421, 4123, 4132, 4213, 4231, 4312, 4321

a. How many of these **combinations** are prime numbers. Check the number sentences with a calculator. We gave you five possible answers.

- d. $1234 = 2 \times 617$ b. 2134
 e. $1243 = 11 \times 113$ d. 2143
 f. $1324 = 2 \times 2 \times 331$ f. 2314
 g. $1342 = 2 \times 11 \times 61$ h. 2341
 i. 1423 is a prime number j. 2413
 k. 1432 l. 2431
 m. 3124 n. 4123
 o. 3142 p. 4132
 q. 3214 r. 4213
 s. 3241 t. 4231
 u. 3412 v. 4312
 w. 3421 x. 4321

3. How many of these 24 combinations in question 2 can be divided by 2 and 4? Work out a set of ratios as shown below.

Example: All the numbers ending with an even number is divisible by 2. There are 12 numbers divisible by	Divisible by 2 (12 numbers)	Divisible by 4
a. What is the ratio of the numbers not divisible by 2 (or 4) to all the numbers divisible by 2 (or 4) ? [part to part]	12:12	
b. What is the ratio of the numbers divisible by 2 (or 4) to all the numbers not divisible by 2 (or 4) ? [part to part]	12:12	
c. What is the ratio of numbers not divisible by 2 (or 4) to all the numbers ? [part to whole] • Write it as a fraction? • Write it as a percentage?	12:24 $\frac{12}{24}$ or $\frac{1}{2}$ 50 %	
d. What is the ratio of numbers divisible by ____ to all the numbers ? [part to whole] • Write it as a fraction? • Write it as a percentage?	12:24 $\frac{12}{24}$ or $\frac{1}{2}$ 50 %	

Problem solving

Use the 5-digit number 12,345 and show which numbers have a ratio of $\frac{1}{4}$ to the total of all numbers?

Proportional sharing

There are 1 000 tennis balls in each container. How many tennis balls are in each circle?

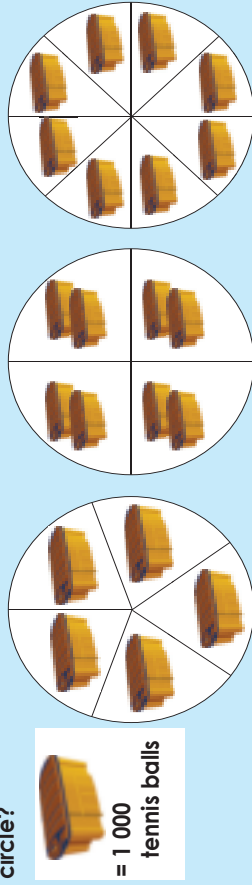

1. Look at the fraction circles above and answer the questions.

- a. What is $\frac{1}{5}$ of 5 000?
- b. What is $\frac{2}{5}$ of 5 000?
- c. What is $\frac{3}{5}$ of 5 000?
- d. What is $\frac{4}{5}$ of 5 000?
- e. What is $\frac{1}{4}$ of 8 000?
- f. What is $\frac{2}{4}$ of 8 000?
- g. What is $\frac{3}{4}$ of 8 000?
- h. What is $\frac{1}{8}$ of 8 000?
- i. What is $\frac{2}{8}$ of 8 000?
- j. What is $\frac{3}{8}$ of 8 000?
- k. What is $\frac{4}{8}$ of 8 000?
- l. What is $\frac{5}{8}$ of 8 000?
- m. What is $\frac{6}{8}$ of 8 000?
- n. What is $\frac{7}{8}$ of 8 000?
- o. What is $\frac{8}{8}$ of 8 000?

2. Look at the number line and answer the questions below.

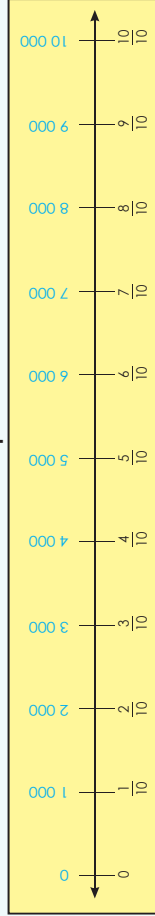

- a. What is $\frac{2}{10}$ of 10 000?
- b. What is $\frac{7}{10}$ of 10 000?
- c. What is $\frac{9}{10}$ of 10 000?
- d. What is $\frac{5}{10}$ of 10 000?

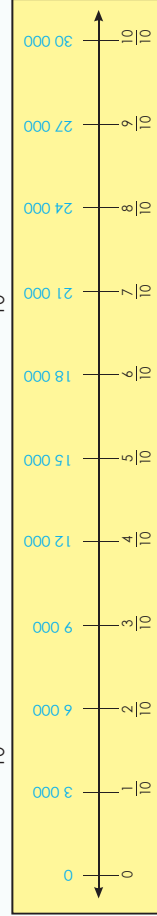

- e. What is $\frac{2}{10}$ of 30 000?
- f. What is $\frac{6}{10}$ of 30 000?
- g. What is $\frac{8}{10}$ of 30 000?
- h. What is $\frac{5}{10}$ of 30 000?

3. Use the fraction circles to answer the following:

- a. Total apples transported to the market in 3 months.
- i. How many apples were transported to the market?
- ii. What is $\frac{1}{3}$ of the apples?
- iii. What is $\frac{2}{3}$ of the apples?

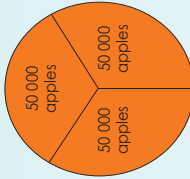

- b. Total of people visiting an exhibition for 6 days.
- i. How many people in total visited the exhibition?
- ii. What is $\frac{1}{6}$ of the people?
- iii. What is $\frac{2}{6}$ of the people?
- iv. What is $\frac{3}{6}$ of the people?
- v. What is $\frac{4}{6}$ of the people?
- vi. What is $\frac{5}{6}$ of the people?

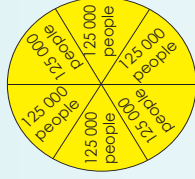

- c. The total amount of goods they sold in one year.
- i. What is the total amount of goods sold per year?
- ii. What is $\frac{2}{12}$ of the total amount?
- iii. What is $\frac{6}{12}$ of the total amount?
- iv. What is $\frac{9}{12}$ of the total amount?
- v. What is $\frac{11}{12}$ of the total amount?

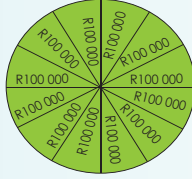

4. If I buy R200 worth of goods and they say I got less than $\frac{3}{4}$ of the price.

How much did I pay for the goods?

Advertisement



Go through a newspaper. Find any article, advertisement, etc. where they mention fractions.

Look at the fractions circles. What do they mean?

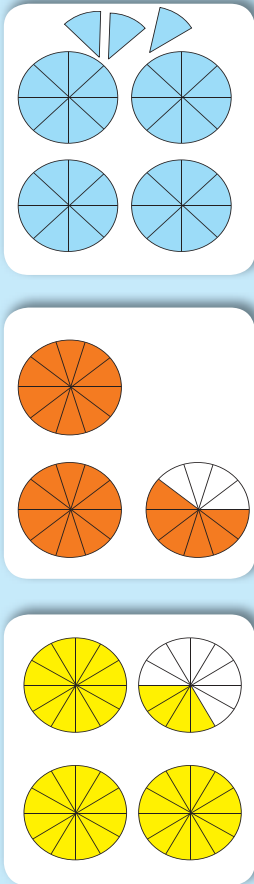

1. Add the following. Remember to write your answer in the simplest form.

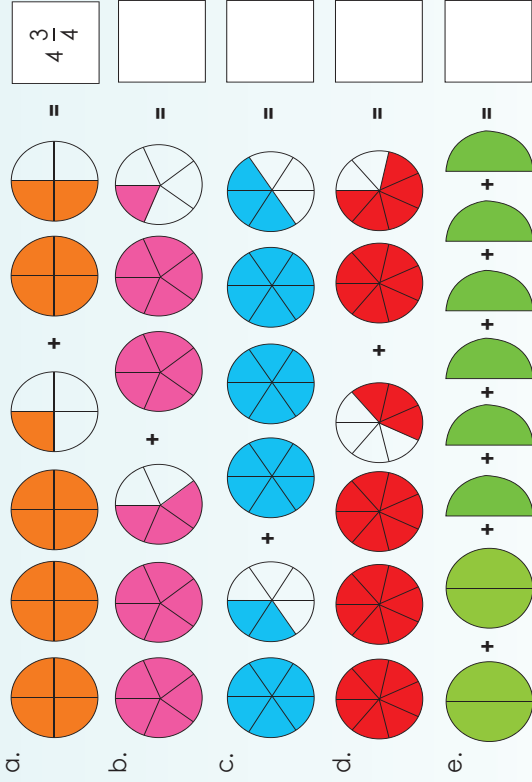

2. Add the following fractions with the same denominators.

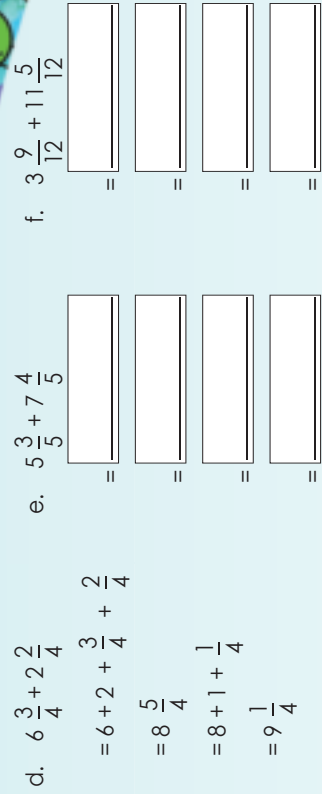
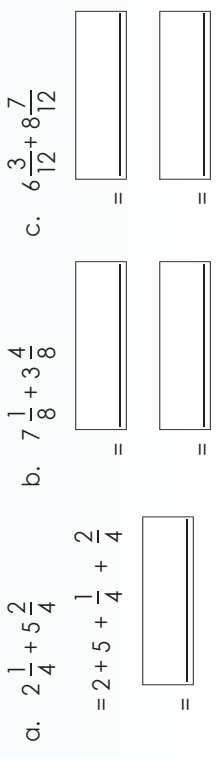

3. Add the following fractions with different denominators.

Do the fractions have the same denominator?

If not, rename with a common denominator.

Add the whole numbers and then the fractions.

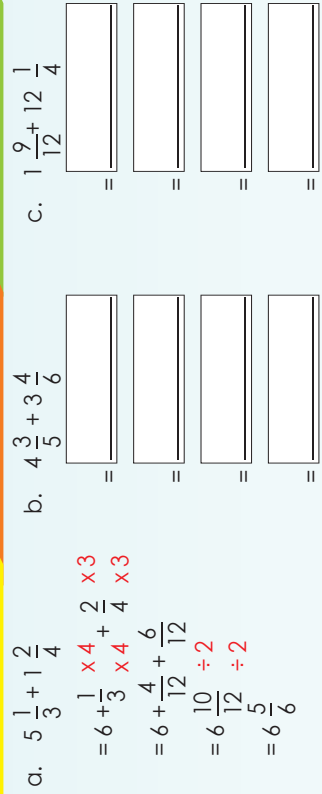

4. My mother has been working for $4\frac{1}{2}$ days and then she rested for 2 days and then worked another $4\frac{1}{4}$ days. For how many days did she work?

What is the magic fraction?

6	$2\frac{1}{2}$	5
$3\frac{1}{2}$	$4\frac{1}{2}$	$5\frac{1}{2}$
4	$6\frac{1}{2}$	3

Fractions: more mixed numbers

Sipho's recipe need $5\frac{1}{4}$ cups of flour. He has $1\frac{1}{2}$ cups. How much more flour does he need?



1. Subtract the following. Remember to write your answer in the simplest form.

a. - = $1\frac{1}{4}$

b. - = $\frac{1}{4}$

c. - = $\frac{1}{4}$

d. - = $\frac{1}{4}$

e. - = $\frac{1}{4}$

2. Subtract the following fractions with the same denominators:

a. $8\frac{3}{4} - 3\frac{1}{4}$
 $= (8 - 3) + (\frac{3}{4} - \frac{1}{4})$
 $=$

b. $9\frac{4}{8} - 5\frac{3}{8}$
 $=$

c. $7\frac{9}{12} + 4\frac{4}{12}$
 $=$

d. $6\frac{1}{4} - 2\frac{2}{4}$
 $= (5 + 1 + \frac{1}{4}) - (2 + \frac{2}{4})$
 $= (5 + \frac{5}{4}) - (2 + \frac{2}{4})$
 $= (5 - 2) + (\frac{5}{4} - \frac{2}{4})$
 $= 3\frac{3}{4}$

e. $8\frac{3}{5} - 4\frac{4}{5}$
 $=$
 $=$
 $=$
 $=$

f. $12\frac{4}{12} + 11\frac{5}{12}$
 $=$
 $=$
 $=$
 $=$

3. Subtract the following fractions different denominators:

Do the fractions have the same denominator?

If not, rename with a common denominator.

Add the whole numbers and then the fractions.

a. $5\frac{1}{3} - 1\frac{1}{4}$
 $= 4 + (\frac{1}{3} \times 4 - \frac{1}{4} \times 3)$
 $= 4 + (\frac{4}{12} - \frac{3}{12})$
 $= 4\frac{1}{12}$

b. $9\frac{4}{5} - 5\frac{2}{7}$
 $=$
 $=$
 $=$

c. $12\frac{8}{9} - 11\frac{1}{6}$
 $=$
 $=$
 $=$

4. At the start of summer, the tree was $4\frac{3}{8}$ metres tall. The farmer cut off $2\frac{3}{4}$ metres. During the summer, it grew another $1\frac{1}{6}$ metres. How tall was the tree by the end of summer?

What is the magic fraction?

$4\frac{2}{3}$	$2\frac{1}{2}$	4
3	$3\frac{2}{3}$	$4\frac{1}{3}$
$3\frac{1}{3}$	5	$2\frac{2}{3}$

Make your own fractions sentences using the words below. Try to use as many words you can in one sentence.

one quarter one half 500 ml one tenth
 250 g 200 mm 125 mm 10 cm
 one fifth one eighth

1. Say if the following is true or false:

- a. $\frac{1}{10}$ of a 1 000 ml jug equals to 1 litre.
- b. $\frac{1}{5}$ of a 100 equals to 20.
- c. $\frac{1}{1}$ is bigger than $\frac{1}{4}$.
- d. 200 g is a quarter of 1 kg.
- e. 25 % of R20 is R5.

2. Look at the diagram and complete the table below:

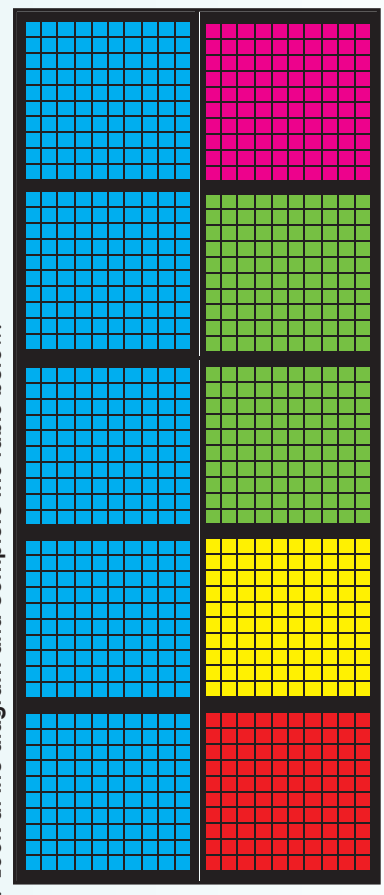

Coloured in	Common Fraction	Decimal fraction	Percentage
Blue			50 %
Red			
Yellow		0,1	
Green			
Pink	$\frac{100}{1000}$		

3. Place a tick (✓) next to the correct answer:

- a. One eighth of 1 m is:
 - i. 500 mm
 - ii. 125 mm
 - iii. 800 mm
- b. Which fraction is bigger than $\frac{1}{8}$?
 - i. $\frac{1}{4}$
 - ii. $\frac{1}{9}$
 - iii. $\frac{1}{12}$
- c. Which fraction is smaller than $\frac{1}{4}$?
 - i. $\frac{1}{3}$
 - ii. $\frac{1}{2}$
 - iii. $\frac{1}{5}$
- d. One half of 60 kg is?
 - i. 120 kg
 - ii. 30 kg
 - iii. 60 kg
- e. $\frac{1}{4} + \frac{1}{4} =$
 - i. $\frac{1}{4}$
 - ii. $\frac{2}{4}$
 - iii. $\frac{2}{8}$
- f. $\frac{2}{3} + \frac{1}{4} =$
 - i. $\frac{11}{12}$
 - ii. $\frac{3}{7}$
 - iii. $\frac{3}{12}$
- g. $\frac{2}{6} + \frac{4}{7} =$
 - i. $\frac{38}{42}$
 - ii. $\frac{1}{1}$
 - iii. $\frac{6}{13}$
- h. $1\frac{1}{2} + 2\frac{1}{3} =$
 - i. $3\frac{5}{6}$
 - ii. $3\frac{2}{5}$
 - iii. $3\frac{2}{6}$
- i. 50 % of R10 is:
 - i. R500
 - ii. R50
 - iii. R5

What is the magic fraction?

118 Equivalent fractions

Which of the following fractions are equal?

$\frac{1}{5}$	$\frac{2}{8}$	40%	0,9
0,45	18%	$\frac{4}{16}$	100%

- By just looking at these fractions, can you tell which are equal?
- Is there a way to work out if any of these fractions are equal?
- YES, we need the fractions to be in the same form to work out if they are equal.

1. Convert to common fractions (remember simplest form).

a. 80%	b. 0,25	c. 0,5	d. 21%
$\frac{80}{100} = \frac{8}{10} = \frac{4}{5}$	$\frac{25}{100} = \frac{5}{20} = \frac{1}{4}$		
e. 58%	f. 0,72	g. 0,81	h. 0,16
i. 67%	j. 45%	k. 63%	l. 0,87
2. Convert to decimal fractions.			
a. 32%	b. $\frac{4}{10}$	c. $\frac{2}{5}$	d. 28%
$\frac{32}{100} = 0,32$	$\frac{2}{5} = \frac{40}{100} = 0,4$		
e. 49%	f. $\frac{1}{4}$	g. $\frac{5}{25}$	h. $\frac{89}{100}$
i. 66%	j. 25%	k. 13%	l. $\frac{14}{20}$

Term 1

3. Convert to percentages.

a. $\frac{4}{10}$	b. 0,8	c. 0,5	d. $\frac{89}{100}$
$\frac{4}{10} = \frac{40}{100} = 40\%$	$\frac{8}{10} = \frac{80}{100} = 80\%$		
e. $\frac{56}{100}$	f. 0,42	g. 0,21	h. 0,96
i. $\frac{3}{20}$	j. $\frac{18}{25}$	k. $\frac{38}{50}$	l. 0,37

4. Fill in <, > or =.

a. 85%	<input type="text"/>	85%	h. 23%	<input type="text"/>	0,23
b. $\frac{4}{10}$	<input type="text"/>	0,4	i. $\frac{47}{100}$	<input type="text"/>	0,74
c. $\frac{4}{10}$	<input type="text"/>	40%	j. 55%	<input type="text"/>	$\frac{5}{100}$
d. 25%	<input type="text"/>	0,25	k. 0,95	<input type="text"/>	100%
e. 67%	<input type="text"/>	$\frac{17}{25}$	l. $\frac{1}{4}$	<input type="text"/>	25%
f. 0,98	<input type="text"/>	$\frac{9}{20}$	m. 10%	<input type="text"/>	$\frac{6}{25}$
g. 0,65	<input type="text"/>	0,6	n. 30%	<input type="text"/>	0,35

Number line fractions

Draw a number line that starts at 0 and ends at 1. Place the following on the number line:
 $\frac{3}{10}$, 20%, $\frac{2}{3}$ and 0,5.

Addition and subtraction of common fractions

Work through these two examples and then answer the questions.

Example 1:

$$\frac{4}{10} + \frac{4}{10} = \frac{8}{10} = \frac{4}{5}$$

Example 2:

$$\begin{aligned} \frac{1}{2} + \frac{2}{8} &= \frac{1}{2} - \frac{2}{8} = \frac{1}{2} \times \frac{4}{4} + \frac{2}{8} \\ \frac{1}{2} + \frac{2}{8} &= \frac{1}{2} \times \frac{4}{4} + \frac{2}{8} \\ &= \frac{4}{8} + \frac{2}{8} \\ &= \frac{6}{8} \end{aligned}$$

Don't forget that the denominator stays the same and only the numerator is added or subtracted.

The first thing we need to do is make sure that the denominators are the same. They are not, so now we need to find multiples of both the denominators.

Remember when we change the denominator, we change the numerator as well, because **what we do to the bottom, we have to do to the top.**

1. Add the following.

a. $\frac{3}{6} + \frac{2}{6} =$

--	--

b. $\frac{3}{10} + \frac{5}{10} =$

--	--

c. $\frac{6}{9} + \frac{2}{9} =$

--	--

d. $\frac{2}{3} + \frac{1}{2} =$

--	--

e. $\frac{5}{7} + \frac{4}{14} =$

--	--

f. $\frac{2}{8} + \frac{5}{6} =$

--	--

2. Subtract the following.

a. $\frac{6}{9} - \frac{2}{9} =$

--	--

b. $\frac{8}{10} - \frac{6}{10} =$

--	--

c. $\frac{8}{12} - \frac{5}{12} =$

--	--

d. $\frac{2}{3} - \frac{4}{12} =$

--	--

e. $\frac{3}{4} - \frac{4}{16} =$

--	--

f. $\frac{8}{9} - \frac{1}{2} =$

--	--

3. Fill in the missing information.

a. $\frac{1}{4} - \frac{1}{4} = \frac{\square}{\square}$

b. $\frac{\square}{5} - \frac{1}{5} = \frac{3}{5}$

c. $\frac{4}{7} + \frac{\square}{\square} = \frac{15}{21}$

d. $\frac{1}{4} + \frac{\square}{\square} = \frac{6}{8}$

e. $\frac{2}{4} + \frac{\square}{\square} = \frac{4}{4}$

f. $\frac{1}{8} + \frac{3}{16} = \frac{\square}{\square}$

g. $\frac{\square}{\square} + \frac{3}{6} = 1$

h. $\frac{1}{2} + \frac{5}{29} = \frac{\square}{\square}$

i. $\frac{2}{4} + \frac{\square}{\square} = \frac{15}{24}$

4. Story sum.

Maria cuts a cake into 20 pieces. She eats $\frac{1}{2}$ of the cake now and $\frac{1}{3}$ later. What fraction of the cake did she eat?

--	--

Pie problems

My father eats $\frac{8}{13}$ of a pie and later another $\frac{1}{3}$. What fraction of the pie did my father eat?

--	--

Look at the example and discuss.

James saves R1 565 for a game. When he gets to the shop it is discounted by $\frac{2}{5}$. How much money does he save?

What is the question? How much money does he save?

What are the numbers or fractions? R1 565 and $\frac{2}{5}$

What is the key word? I am going to use sharing.

What will the number sentence be? $\frac{2}{5}$ of R1 565 =

Possible drawing: I will first start to share R1 565 between 5.



I will then circle $\frac{2}{5}$ of the purses and add the money. $R313 + R313 = R623$
James saved R623.

1. Solve the following problems.

- a. My aunt's food budget is R 3 500. She saves $\frac{1}{5}$ of her budget. How much money did she save?

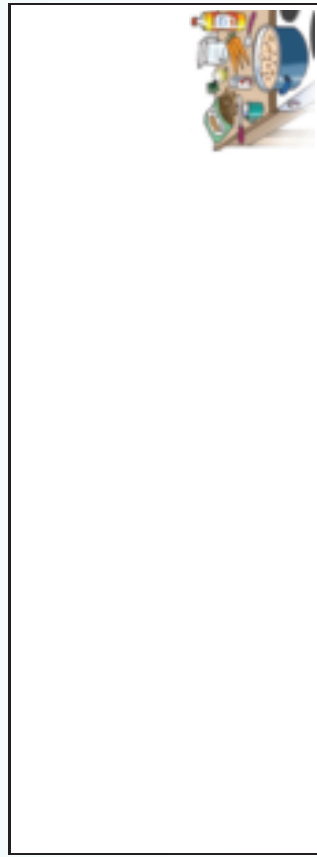

- b. A wall has 124 panels. A painter paints $\frac{4}{6}$ of these panels. How many panels are painted?

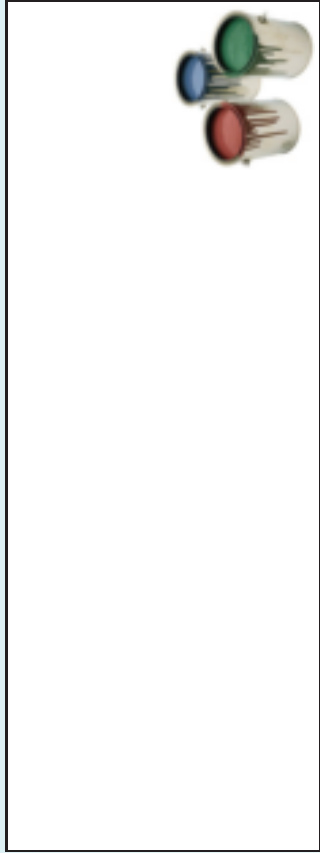

- c. What is $\frac{2}{6}$ of 354 cup-cakes?



- d. Bongji's father has 364 sweets. He gives $\frac{3}{7}$ of them to her mother for school lunch-boxes. How many sweets will she get?



Fraction problem solving continued

120b

- e. Thandi uses one 50 l container of paraffin for her stove. If she has used $\frac{3}{5}$ of the bottle already, how many litres are left?



- f. Jack has worked on his homework for $\frac{3}{5}$ of 3 hours. How many minutes have passed?



- g. Grandfather uses $\frac{2}{8}$ of his 800 ml of gel. How much gel has he used?



- h. My friend's cat weighs 1 568 g and her kitten weighs $\frac{2}{6}$ of the cat's mass. What is the mass of the kitten?

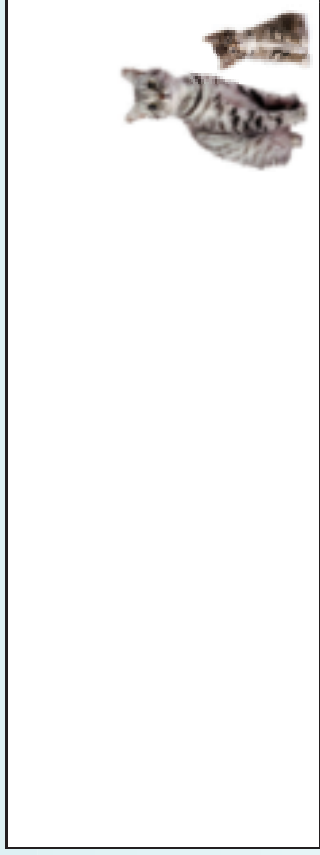

- i. A chocolate cake needs $\frac{3}{4}$ cup of flour. If my mother wants to bake 5 cakes, how much flour will she need?

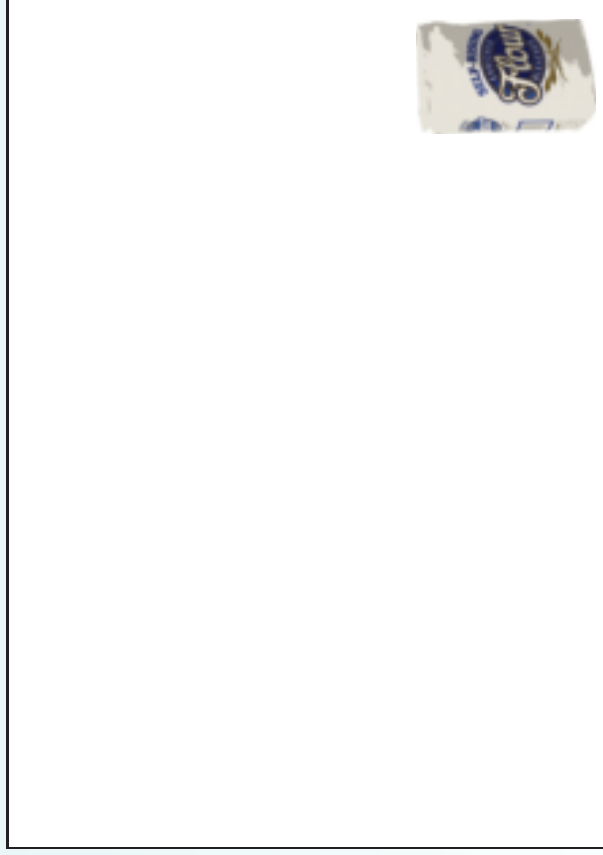

Solve more word problems

- Phulani has 1 452 stamps. If she gives $\frac{2}{6}$ of the stamps to her friend, how many stamps will they each have?
- Zama earns $\frac{2}{5}$ of what his father earns in a month. If his father earns R18 000, how much does Zama earn?

Page:

Date:

Faces, vertices and edges

Look at the picture. Which country is this? Match one of the objects on the right with the picture.

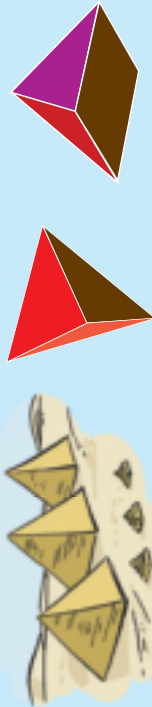

1. Label the parts of these diagrams.

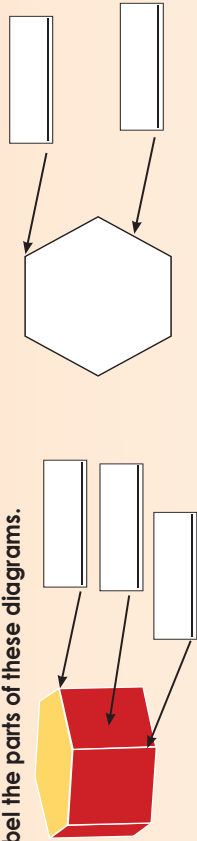

2. Complete the following table:

Faces of the 3D object	3D object	Net	Number of faces	Number of vertices	Number of edges
2 triangles	Triangular prism 				
3 rectangles	Rectangular prism 				
	Pentagonal prism 				
	Tetrahedron 				

3. Describe these houses in terms of 2-D shapes and 3D objects. Use words such as:

3D objects

edges

2-D shapes

faces

vertices



Lined writing area for describing the houses.

Continue on an extra sheet of paper.

Designing a house

You need to design a variety of houses. How many different houses can you design using some objects as roofs and others as wall structures?



Revise vertices, edges and faces.

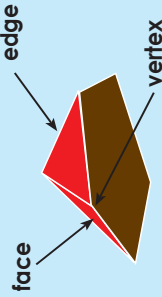
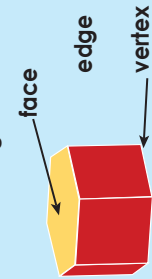

1. Identify and count the:

- i. vertices
- ii. edges
- iii. faces



- i. _____
- ii. _____
- iii. _____



- i. _____
- ii. _____
- iii. _____



- i. _____
- ii. _____
- iii. _____



- i. _____
- ii. _____
- iii. _____



- i. _____
- ii. _____
- iii. _____



- i. _____
- ii. _____
- iii. _____

2. Find or draw pictures of objects with:

- a. 8 vertices, 12 edges and 6 faces

- b. 4 vertices, 6 edges and 4 faces

3. Can a 3-D object have equal numbers of vertices, edges and faces ?

4. Match the skeleton with the 3-D object. Label and say how many of the following you count.

- i. faces
- ii. edges
- iii. vertices

a. Pentagonal pyramid

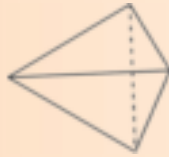

- i. _____
- ii. _____
- iii. _____

b. Hexagonal pyramid



- i. _____
- ii. _____
- iii. _____

c. Square pyramid



- i. _____
- ii. _____
- iii. _____

d. Triangular pyramid (tetrahedron)

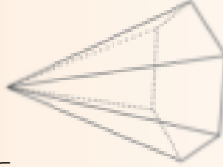

- i. _____
- ii. _____
- iii. _____

5. Count the:

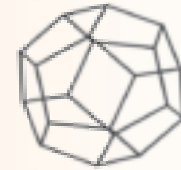

- Faces _____
- Edges _____
- Vertices _____

6. Compare the tetrahedron above with all the other pyramids.

What is it?

What 3-D object will have seven vertices and seven faces?

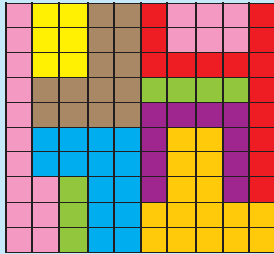

How many square units are:

- a. Pink
- b. Green
- c. Blue
- d. Purple
- e. Yellow
- f. Orange
- g. Brown
- f. Red

1. Write a sum to work out the square units.

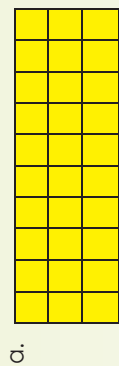

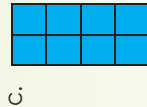

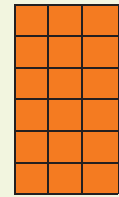

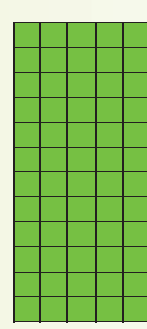

2. Label each side saying if it is the length or the width of the rectangle. Then write a sum for each rectangle

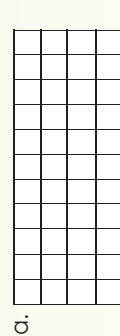

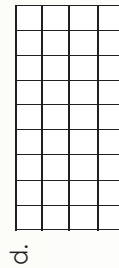

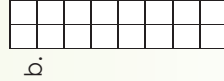

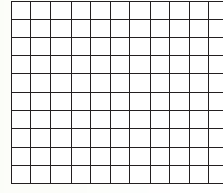

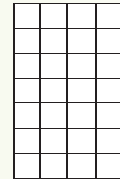

3. Draw 10 different rectangles. What is the area of each rectangle? Give your answer in square units.

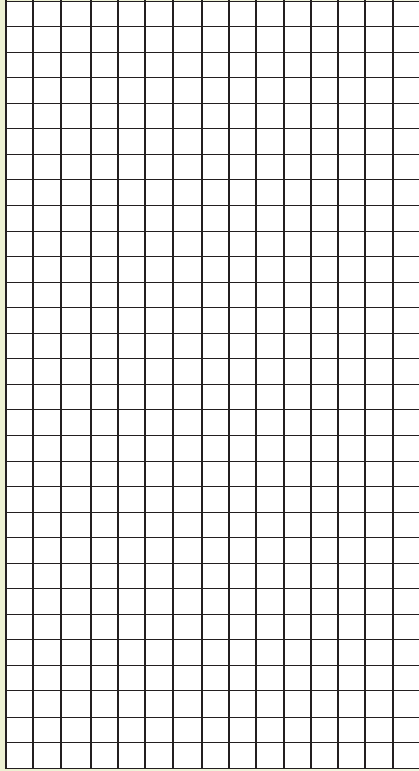

4. Work out the square units for each shape. Write down how you did it.

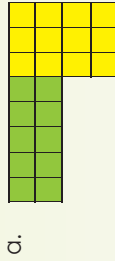

a.

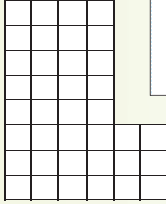

b.

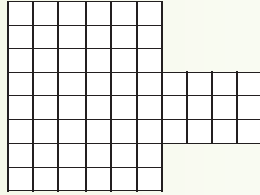

c.

What is the size of the dam?

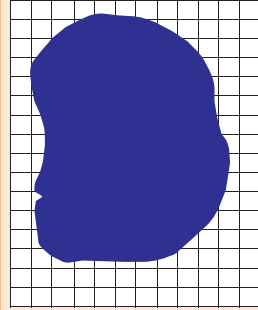

Area and perimeter

123b

Read about perimeter and area below.

Perimeter is the distance around a 2-D shape.



The perimeter of this rectangle is $8\text{ cm} + 8\text{ cm} + 2\text{ cm} + 2\text{ cm} = 20\text{ cm}$



Area is the amount of space inside the perimeter.



The area covered by this shape is $2\text{ cm} \times 8\text{ cm} = 16\text{ cm}^2$



1. Calculate the perimeter and area of the following rectangles.

a. 3 cm



Perimeter

Area

b. 1 cm

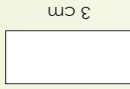

Perimeter

Area

c. 3 cm

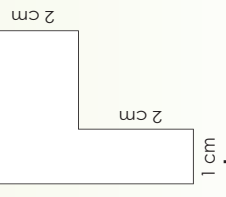

Perimeter

Area

d. 1 cm



Perimeter

Area

2. Calculate the perimeter and area of the following rectangles:

a. Length: 10 cm; Width: 8 cm

Perimeter

Area

Perimeter

Area

b. Length: 25 cm; Width: 20 cm

3. If you have a rectangle with the following area, what could its length and breadth (width) be? What is the perimeter?

a. Area = 72 square metres (m^2).

Length and breadth

Perimeter

Length and breadth

Perimeter

b. Area = 108 m^2

4. Themba has a small garden with a perimeter of 30 metres and an area of 30 square metres. He wants to double the dimensions of his garden next year. What will be the new perimeter and new area of his larger garden? Show the calculations.

Continue on a separate sheet of paper

5. Mpho and his father are building a deck because the old one is too small. The old deck was 2 m x 3 m. They are going to double the dimensions of the deck. They'll need to know how much railing and wood stain to purchase. What will be the perimeter and area of the new deck be? Show the calculations.

Continue on a separate sheet of paper

Investigate

How many different ways can you draw a square and rectangles covering 36 square units? Show them.

Do all of the above shapes have the same area? Do they all have the same perimeter?

Discuss the following.

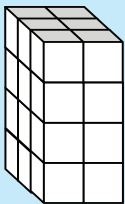

Area

front view



side view

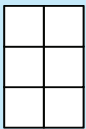

top view

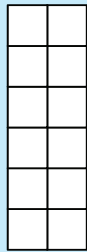

1. Calculate the cubic units.

Count the cube units

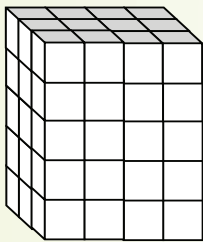

Draw all the faces and then calculate the square areas. We did the first two faces for you. Do the rest on an extra sheet of paper.

5 square units x 4 square units =
5 square units x 4 square units =

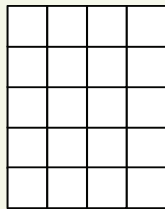
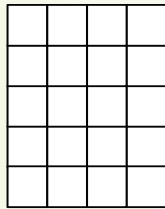

Write it down.

4 cubic units x 5 cubic units x 3 cubic units = $2 \times (5 \times 4) + 2 (3 \times 4) + 2 (5 \times 3)$

2. Calculate the volume and then the area. We did the first drawings for you.

a.

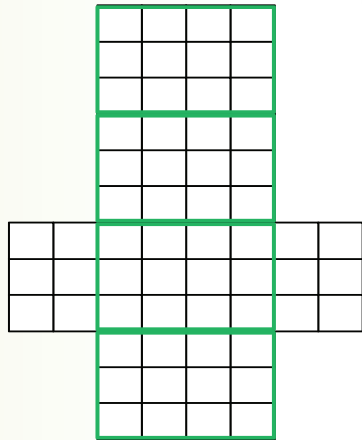
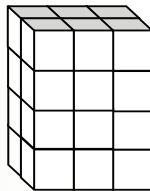

<p>b.</p>	<p>c. You will need extra paper for c-f, 3 cubic units x 3 cubic units x 4 cubic units.</p>
<p>d. 5 cubic units x 6 cubic units x 4 cubic units</p>	
<p>e. 7 cubic units x 8 cubic units x 9 cubic units.</p>	
<p>f. 4 cubic units x 8 cubic units x 12 cubic units.</p>	



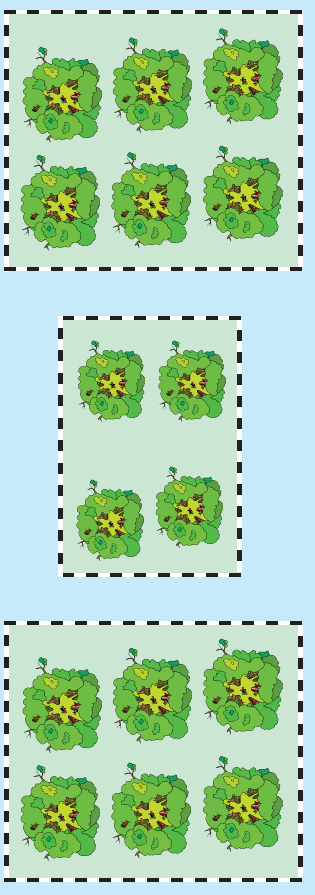

Millimetre fun

What will the surface area in square units be of a rectangular prism with 6 cubic units by 4 cubic by 3 units.

What is the distance around the parks? Use the fencing units to help you.

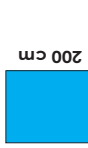
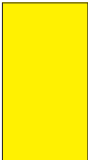

1. Complete the table:

Rectangle	Length	Width	Perimeter in:
30 mm 			mm: <input type="text"/> cm: <input type="text"/> m: <input type="text"/>
30 cm 			mm: <input type="text"/> cm: <input type="text"/> m: <input type="text"/>
150 cm 			mm: <input type="text"/> cm: <input type="text"/> m: <input type="text"/>
275 mm 			mm: <input type="text"/> cm: <input type="text"/> m: <input type="text"/>
132 mm 			mm: <input type="text"/> cm: <input type="text"/> m: <input type="text"/>

2. Draw the rectangles.

Length: 80 mm Width: 40 mm Perimeter in mm: cm: m:

Length: 76 mm Width: 42 mm Perimeter in mm: cm: m:

Length: 92 mm Width: 35 mm Perimeter in mm: cm: m:

Perimeter, length and width continued

125b

3. Calculate the following for each space:

a. The length is 54 cm and the width is 30 cm. What is the perimeter?

Handwriting practice area for question 3a.

b. The length is 108 cm and the width is 76 cm. What is the perimeter?

Handwriting practice area for question 3b.

c. The perimeter is 100 cm. What can the length and width be?
Give 5 possible answers.

Handwriting practice area for question 3c.

d. What is the width, if the perimeter is 90 cm, and one length is 30 cm?

Handwriting practice area for question 3d.

e. What is the length, if the perimeter is 210 cm, and the width is 40 cm?

Handwriting practice area for question 3e.

Perimeter search

How to play: Search for any 5 rectangular shapes in your classroom. First guess what the perimeter is and then measure it. The person that guesses the closest gets one point. The person with the most points is the winner.

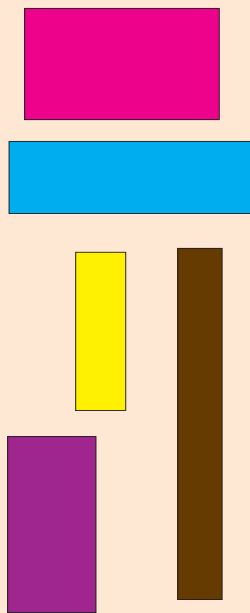

Sign: _____
Date: _____

Calculate the following:

$5(3 + 4) = \square$	$90 \div \square \times 0 = 0$	$7 + 3 + 2 \div 2 = \square$	$25 \times \square \div 5 = 5$
$35 \div 5 \times 1 = \square$	$50 \times \square \div 25 = 25$	$\square \div 5 + 0 = 100$	$4 + 5 \div 3 = \square$
$81 + \square \div 9 = 9$	$3\,000 \div 1\,000 + 0 = \square$	$200 \div 5 + 0 = \square$	$2(7 + 4) = \square$
$7(24 \div 6) = \square$	$490 \div 70 \times 1 = \square$	$6(\square \times 2) = 30$	



Remember **BODMAS** when you calculate.

1. Estimate and then calculate the following:

- a. $2\,500 \div 40 = \square$
- b. $3\,100 \div 80 = \square$
- c. $5\,100 \div 10 = \square$
- d. $4\,400 \div 7 = \square$
- e. $1\,700 \div 40 = \square$
- f. $6\,300 \div 10 = \square$
- g. $3\,200 \div 50 = \square$
- h. $4\,700 \div 40 = \square$

2. Complete the multiplication board.

x	10	20	30	40	50	60	70	80	90	100
10										
20										
30										
40										
50										
60										
70										
80										
90										
100										

- a. Colour the numbers that are divisible by 30 in blue.
- b. Colour the numbers that are not divisible by 30 in red.
- c. How did the multiplication board help you to work it out quickly?

- d. What are the first 10 multiples of 30?

3. Colour the numbers that are divisible by 400 red and the numbers that are divisible by 500 blue.

x	100	200	300	400	500	600	700	800	900	1 000
10										
20										
30										
40										
50										
60										
70										
80										
90										
100										

- a. What do you get when you mix red and blue?

- b. Which numbers are coloured purple?

- c. What do you know about these numbers?

- d. Are the purple numbers divisible by 300?

- e. What are the first 10 multiples of 400 and 500?

- f. What are the factors of 800?

I have a number

In pairs play the following.

Say to your friend: "I have a 2 digit number. It is divisible by 2. Guess what my number is?"
Give your friend some clues until he or she gets it correct.
Take more turns using other numbers.

More division

127a

Quick recall:

6 ÷ 2	28 ÷ 7	14 ÷ 2	12 ÷ 6	40 ÷ 4	16 ÷ 8
12 ÷ 2	40 ÷ 4	42 ÷ 7	18 ÷ 9	16 ÷ 2	24 ÷ 4
21 ÷ 3	6 ÷ 3	10 ÷ 5	30 ÷ 5	54 ÷ 6	90 ÷ 9
72 ÷ 8	45 ÷ 9	63 ÷ 9	40 ÷ 5	56 ÷ 7	27 ÷ 3
20 ÷ 5	56 ÷ 8	32 ÷ 4	24 ÷ 3	15 ÷ 3	8 ÷ 4

Example 1:

$$\begin{aligned} 364 \div 50 &= (300 + 64) \div 50 \\ &= (300 \div 50) + (64 \div 50) \\ &= 6 + 1 + \text{remainder } 14 \\ &= 7 \text{ remainder } 14 \end{aligned}$$

Test the answer.

Example 2:

$$\begin{aligned} 785 \div 70 &= (700 + 85) \div 70 \\ &= (700 \div 70) + (85 \div 70) \\ &= 10 + 1 \text{ remainder } 15 \\ &= 11 \text{ remainder } 15 \end{aligned}$$

Test the answer.

1. Show your calculations.

a. $278 \div 50 =$

b. $463 \div 50 =$

c. $871 \div 50 =$

d. $983 \div 50 =$

e. $391 \div 50 =$

2. Show your calculations.

c. $438 \div 70 =$

b. $223 \div 70 =$

c. $291 \div 70 =$

d. $713 \div 70 =$

e. $859 \div 70 =$

Continue on an extra sheet of paper

Continue on an extra sheet of paper

Example 3:

$$\begin{aligned} 674 \div 60 &= (600 + 74) \div 60 \\ &= (600 \div 60) + (74 \div 60) \\ &= 10 + 1 \text{ remainder } 14 \\ &= 11 \text{ remainder } 12 \end{aligned}$$

Example 4:

$$\begin{aligned} 894 \div 80 &= (800 + 94) \div 80 \\ &= (800 \div 80) + (94 \div 80) \\ &= 10 + 1 \text{ remainder } 14 \\ &= 11 \text{ remainder } 14 \end{aligned}$$

3. Show your calculations.

a. $738 \div 60 =$

b. $253 \div 60 =$

c. $131 \div 60 =$

d. $193 \div 60 =$

e. $491 \div 60 =$

Continue on an extra sheet of paper

4. Show your calculations.

a. $178 \div 80 =$

b. $253 \div 80 =$

c. $331 \div 80 =$

d. $415 \div 80 =$

e. $496 \div 80 =$

Continue on an extra sheet of paper

Division: 4-digit by 2-digit numbers

Example 1:

$$\begin{array}{r} 202 \\ 17 \overline{) 3434} \\ \underline{- 341} \\ 30 \\ \underline{- 30} \\ 0 \\ \underline{- 0} \\ 34 \\ \underline{- 34} \\ 0 \end{array}$$

This block might help you with calculations.

D	Division
M	Multiplication
S	Subtraction
B	Bring down

Clue board
 1 x 17 = 17
 2 x 17 = 34
 3 x 17 = 51
 4 x 17 = 68
 5 x 17 = 85
 6 x 17 = 102
 7 x 17 = 119
 8 x 17 = 136
 9 x 17 = 153

Example 2:

$$3434 \div 17 = (3400 \div 17) + (34 \div 17) = 200 + 2 = 202$$

We will write the number in multiples of 17.

We first write 3400 divided by 17 in brackets. Then write the addition symbol. Then write 34 divided by 17 in brackets.

200 plus 2 equals 202

- 3400 divided by 17 is 200
- Plus
- 34 divided by 17 is 2

You do, not have to use both methods, but you should know how to use both.

1. Calculate and check your answers. The blocks might help you with your calculations.

a. $1248 \div 16 =$ b. $1872 \div 24 =$ c. $2529 \div 56 =$

1 x 16 = 16	10 x 16 = 160	1 x 24 = 24	10 x 24 = 240	1 x 56 = 56	10 x 56 = 560
2 x 16 = 32	20 x 16 = 320	2 x 24 = 48	20 x 24 = 480	2 x 56 = 112	20 x 56 = 1120
3 x 16 = 48	30 x 16 = 480	3 x 24 = 72	30 x 24 = 720	3 x 56 = 168	30 x 56 = 1680
4 x 16 = 64	40 x 16 = 640	4 x 24 = 96	40 x 24 = 960	4 x 56 = 224	40 x 56 = 2240
5 x 16 = 80	50 x 16 = 800	5 x 24 = 120	50 x 24 = 1200	5 x 56 = 280	50 x 56 = 2800
6 x 16 = 96	60 x 16 = 960	6 x 24 = 144	60 x 24 = 1440	6 x 56 = 336	60 x 56 = 3360
7 x 16 = 112	70 x 16 = 1120	7 x 24 = 168	70 x 24 = 1680	7 x 56 = 392	70 x 56 = 3920
8 x 16 = 128	80 x 16 = 1280	8 x 24 = 192	80 x 24 = 1920	8 x 56 = 448	80 x 56 = 4480
9 x 16 = 144	90 x 16 = 1440	9 x 24 = 216	90 x 24 = 2160	9 x 56 = 504	90 x 56 = 5040

--	--	--

Clue board
 1 x 126 = 126
 2 x 126 = 252
 3 x 126 = 378
 4 x 126 = 504
 5 x 126 = 630
 6 x 126 = 756
 7 x 126 = 882
 8 x 126 = 1008
 9 x 126 = 1134

Example 1:

$$\begin{array}{r} 23 \\ 126 \overline{) 2898} \\ \underline{252} \\ 378 \\ \underline{378} \\ 0 \end{array}$$

Example 2:

$$2898 \div 126 = (2520 \div 126) + (378 \div 126) = 20 + 3 = 23$$

We will write the number in multiples of 126.

We first write 2520 divided by 126 in brackets. Then write the addition symbol. Then write 378 divided by 126 in brackets.

- 2520 divided by 126 is 20
- Plus
- 378 divided by 126 is 3

20 plus 3 equals 23

You do not have to use both methods; but you should know how to use both.

2. Complete the clue boards. Calculate a-c using the clue boards to help you.

a. $2772 \div 116 =$ b. $2829 \div 123 =$

1 x 116 =	10 x 116 =	1 x 123 =	10 x 123 =	1 x 352 =	10 x 352 =
2 x 116 =	20 x 116 =	2 x 123 =	20 x 123 =	2 x 352 =	20 x 352 =
3 x 116 =	30 x 116 =	3 x 123 =	30 x 123 =	3 x 352 =	30 x 352 =
4 x 116 =	40 x 116 =	4 x 123 =	40 x 123 =	4 x 352 =	40 x 352 =
5 x 116 =	50 x 116 =	5 x 123 =	50 x 123 =	5 x 352 =	50 x 352 =
6 x 116 =	60 x 116 =	6 x 123 =	60 x 123 =	6 x 352 =	60 x 352 =
7 x 116 =	70 x 116 =	7 x 123 =	70 x 123 =	7 x 352 =	70 x 352 =
8 x 116 =	80 x 116 =	8 x 123 =	80 x 123 =	8 x 352 =	80 x 352 =
9 x 116 =	90 x 116 =	9 x 123 =	90 x 123 =	9 x 352 =	90 x 352 =

--	--	--

Story sums

- A farmer wants to plant 6764 apple trees. He can only fit in 76 rows. How many apple trees must he plant in each row?
- A rich man gives boxes of toys to a school. Each box has 126 toys. If there are 5292 toys, how many boxes are needed?

Division: 4-digit by 3-digit numbers with remainders

Example: 398 $\overline{) 6\ 681}$ 16 rem 313

$$\begin{array}{r} 398 \overline{) 6\ 681} \\ \underline{- 3\ 98} \\ 2\ 701 \\ \underline{- 2\ 388} \\ 313 \end{array}$$

1. Complete the clue boards and calculate the sums. (Remember to check your answers.)

a. $2\ 391 \div 129 =$ b. $3\ 277 \div 157 =$ c. $3\ 843 \div 226 =$

$1 \times 129 =$	$10 \times 129 =$	$1 \times 157 =$	$10 \times 157 =$	$1 \times 226 =$	$10 \times 226 =$
$2 \times 129 =$	$20 \times 129 =$	$2 \times 157 =$	$20 \times 157 =$	$2 \times 226 =$	$20 \times 226 =$
$3 \times 129 =$	$30 \times 129 =$	$3 \times 157 =$	$30 \times 157 =$	$3 \times 226 =$	$30 \times 226 =$
$4 \times 129 =$	$40 \times 129 =$	$4 \times 157 =$	$40 \times 157 =$	$4 \times 226 =$	$40 \times 226 =$
$5 \times 129 =$	$50 \times 129 =$	$5 \times 157 =$	$50 \times 157 =$	$5 \times 226 =$	$50 \times 226 =$
$6 \times 129 =$	$60 \times 129 =$	$6 \times 157 =$	$60 \times 157 =$	$6 \times 226 =$	$60 \times 226 =$
$7 \times 129 =$	$70 \times 129 =$	$7 \times 157 =$	$70 \times 157 =$	$7 \times 226 =$	$70 \times 226 =$
$8 \times 129 =$	$80 \times 129 =$	$8 \times 157 =$	$80 \times 157 =$	$8 \times 226 =$	$80 \times 226 =$
$9 \times 129 =$	$90 \times 129 =$	$9 \times 157 =$	$90 \times 157 =$	$9 \times 226 =$	$90 \times 226 =$

d. $5\ 492 \div 286 =$

$1 \times 286 =$	$10 \times 286 =$
$2 \times 286 =$	$20 \times 286 =$
$3 \times 286 =$	$30 \times 286 =$
$4 \times 286 =$	$40 \times 286 =$
$5 \times 286 =$	$50 \times 286 =$
$6 \times 286 =$	$60 \times 286 =$
$7 \times 286 =$	$70 \times 286 =$
$8 \times 286 =$	$80 \times 286 =$
$9 \times 286 =$	$90 \times 286 =$

e. $5\ 926 \div 326 =$

$1 \times 326 =$	$10 \times 326 =$
$2 \times 326 =$	$20 \times 326 =$
$3 \times 326 =$	$30 \times 326 =$
$4 \times 326 =$	$40 \times 326 =$
$5 \times 326 =$	$50 \times 326 =$
$6 \times 326 =$	$60 \times 326 =$
$7 \times 326 =$	$70 \times 326 =$
$8 \times 326 =$	$80 \times 326 =$
$9 \times 326 =$	$90 \times 326 =$

f. $6\ 681 \div 398 =$

$1 \times 398 =$	$10 \times 398 =$
$2 \times 398 =$	$20 \times 398 =$
$3 \times 398 =$	$30 \times 398 =$
$4 \times 398 =$	$40 \times 398 =$
$5 \times 398 =$	$50 \times 398 =$
$6 \times 398 =$	$60 \times 398 =$
$7 \times 398 =$	$70 \times 398 =$
$8 \times 398 =$	$80 \times 398 =$
$9 \times 398 =$	$90 \times 398 =$

g. $8\ 253 \div 412 =$

$1 \times 412 =$	$10 \times 412 =$
$2 \times 412 =$	$20 \times 412 =$
$3 \times 412 =$	$30 \times 412 =$
$4 \times 412 =$	$40 \times 412 =$
$5 \times 412 =$	$50 \times 412 =$
$6 \times 412 =$	$60 \times 412 =$
$7 \times 412 =$	$70 \times 412 =$
$8 \times 412 =$	$80 \times 412 =$
$9 \times 412 =$	$90 \times 412 =$

h. $8\ 981 \div 422 =$

$1 \times 422 =$	$10 \times 422 =$
$2 \times 422 =$	$20 \times 422 =$
$3 \times 422 =$	$30 \times 422 =$
$4 \times 422 =$	$40 \times 422 =$
$5 \times 422 =$	$50 \times 422 =$
$6 \times 422 =$	$60 \times 422 =$
$7 \times 422 =$	$70 \times 422 =$
$8 \times 422 =$	$80 \times 422 =$
$9 \times 422 =$	$90 \times 422 =$

i. $9\ 653 \div 452 =$

$1 \times 452 =$	$10 \times 452 =$
$2 \times 452 =$	$20 \times 452 =$
$3 \times 452 =$	$30 \times 452 =$
$4 \times 452 =$	$40 \times 452 =$
$5 \times 452 =$	$50 \times 452 =$
$6 \times 452 =$	$60 \times 452 =$
$7 \times 452 =$	$70 \times 452 =$
$8 \times 452 =$	$80 \times 452 =$
$9 \times 452 =$	$90 \times 452 =$



What will happen:

If I subtract the same number from the number?



If I add or subtract 0 from a number?

If I multiply a number by 1?

1. Complete the following:

- a. $4 - \square = 0$
- b. $\square - 15 = \square$
- c. $100\ 000 - \square = \square$
- d. $\square - 299\ 999 = 0$
- e. $\square - \square = \square$

2. Replace:

- = 5 ■ = 25 ■ = $\frac{1}{4}$
- = 0,5 ■ = 500 000
- a. ● - ● = 0
- b. ■ - ■ = 0
- c. ■ - ■ = 0
- d. ■ - ■ = 0
- e. ■ - ■ = 0

3. Complete the flow diagrams.

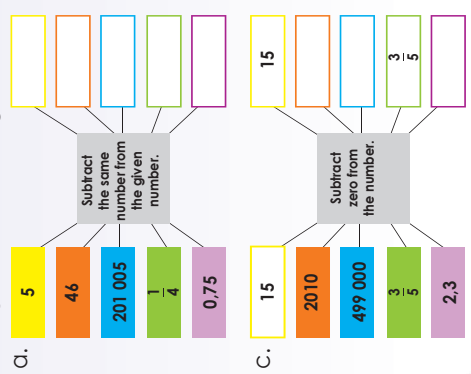

4. What is the value of X :

- a. $X + 19 = 19 + 5$
- b. $8 \times 25 = X \times 8$
- c. $(12 + X) + 14 = 12 + (15 + 14)$
- d. $(10 \times 0,5) \times 1 = 10 \times (X \times 0,5)$
- e. $(90 + 10) \times 0,2 = 90 \times X + 10 \times$
- f. $478\ 321 + 0 = X$
- g. $327\ 321 \times 1 = X$
- h. $289\ 471 - X = 0$
- i. $2,5 + X = 2,5$
- j. $7,9 \times X = 7,9$

X =

X =

X =

X =

X =

X =

X =

X =

X =

X =

5. If, $a = 10$, $b = 200$, and $c = 3\ 000$, then complete and calculate the sums.

- a. $a + b = b + a$
- b. $a \times b = b \times a$
- c. $(a + b) + c = a + (b + c)$
- d. $(a \times b) \times c = a \times (b \times c)$
- e. $(a + b) \times c = a \times c + b \times c$
- f. $a - a =$
- g. $c \times 1 =$
- h. $b + 0 =$

Sudoku fun

Solve the Sudoku puzzle.
 Each blocks of 9 squares must have all the numbers 1 to 9.
 Each horizontal row must have all the numbers 1 to 9.
 Each vertical column must have all the numbers 1 to 9.

5	4	2	9					1
		5						4
		7			9			
8			3			6	7	
			6		5			
9	3		1				2	
				1		6		
2					6			
3		1	7		4	9		

Order of operations

Who has the correct answer? Tick the answer that is correct and explain why.

$$\begin{aligned} 2 + 3 \times 4 &= 20 \\ &= 5 \times 4 \end{aligned}$$

$$2 + 3 \times 4$$

$$\begin{aligned} &= 2 + 12 \\ &= 14 \end{aligned}$$

1. Do the operation marked in blue first. Compare your answers.

$22 + 43 - 15 =$

$15 \times 8 + 6 =$

$22 + 43 - 15 =$

$15 \times 8 + 6 =$

$24 - 12 \div 6 =$

$2 \times 80 \div 4 =$

$24 - 12 \div 6 =$

$2 \times 80 \div 4 =$

2. Follow the BODMAS order of operation to calculate each of the following:

The order in which we carry out a calculation is important.

Stands for:
B Brackets
O Orders (powers and square roots)
D Division and
M Multiplication (left-to-right)
A Addition and
S Subtraction (left-to-right)

- a. $7 - 3 + 6 =$
- b. $16 + 29 - 87 =$
- c. $38 - 12 - 15 =$
- d. $(20 \div 10) + 3 =$
- e. $13 + (7 \times 6) =$
- f. $(56 \div 28) \times 5 + 12 =$
- g. $18 - (12 \div 3) + 6 =$
- h. $(96 \div 16) \times 2 =$
- i. $27 - (16 \div 8) \times 11 =$
- j. $49 \div (56 \div 8) - 4 =$
- k. $18 \times (13 - 11) \div 6 =$
- l. $35 \div 5 + (18 - 16) =$
- m. $29 - 6 \times (8 - 7) =$
- n. $(30 \div 15) + (3 \times 7) =$
- o. $(17 - 9) \div 2 - 3 =$
- p. $34 - (16 \times 2) + 7 =$
- q. $14 \div (36 - 29) + 11 =$
- r. $56 \div 2 \div (2 \times 4) =$

3. Organize the operations so that each equation is correct. Use each symbol only once.

- ÷ × ()

- a. $18 \square 6 \square 3 \square 5 = 30$
- b. $24 \square 3 \square 9 \square 2 = 1$
- c. $15 \square 3 \square 2 \square 4 = 6$
- d. $21 \square 3 \square 8 \square 1 = 2$

4. Organise the numbers so that each equation is correct. Use each number only once per equation.

20 4 5 10

- a. $(\square - \square) \times \square \div \square = 2$
- b. $(\square - \square) \times \square \div \square = 25$
- c. $(\square - \square) \times \square \div \square = 6$
- d. $(\square - \square) \times \square \div \square = 8$

5. Organise the numbers and operations so that each equation is correct. Use each number only once per equation.

6 12 18 36 - + () ÷

- a.
- b.
- c.
- d.

Sudoku fun

3	9		2		6
5		8	6		
2					3
3	7				
	1	6	8		
4			1	9	7
		4	3	5	
8		6			3

Quick recall:

$900\,000 + 1 =$	$800\,000 - 10\,000 =$	$600\,000 - 10 =$
$200 \times 1\,000 =$	$8\,000 \times 100 =$	$800\,000 \div 10\,000 =$
$700\,000 - 2\,000 =$	$700\,000 + 50 =$	$500 \times 300 =$
$900\,000 \div 100\,000 =$	$600\,000 \div 1\,000 =$	$400\,000 \div 10 =$
$500\,000 + 1\,000 =$	$300 \times 3\,000 =$	$800\,000 + 900 =$

1. Work these out in your head:

- a. 18 plus 28
- b. 8 multiplied by 9
- c. The sum of 26 and 32
- d. Divide 890 by 10
- e. The product of 25 and 4
- f. What is the remainder if 87 is divided by 5?
- g. What is 30 less than 5 time a thousand?



2. Circle the correct answer.

- a. Another word for addition is:
 - i. subtraction
 - ii. product
 - iii. plus
- b. Minus means the same as:
 - i. subtraction
 - ii. product
 - iii. divide
- c. One million has zeros.
 - i. 4
 - ii. 5
 - iii. 6
- d. One million is a digit number.
 - i. 5
 - ii. 6
 - iii. 7
- e. The product of 20 and 200 is:
 - i. 220
 - ii. 4 000
 - iii. 180
- f. When adding or subtracting, if a number ends with a 9 round it off to the next 10, and then take away or add .
 - i. 10
 - ii. 9
 - iii. 1
- g. 62 r 3. The r stands for:
 - i. remainder
 - ii. number
 - iii. revision
- h. Share 900 000 between 2:
 - i. 900
 - ii. 450 000
 - iii. 700 000

3. Say if the following is true or false:

- a. All whole numbers that end in 0 or 5 are divisible by 10.
- b. All even numbers are divisible by 2.
- c. All odd numbers will have a remainder of 1 when divided by 2.
- d. All whole numbers that end with 0 or 3 are exactly divisible by 5.
- e. All whole numbers are divisible by 1.

4. Match column A with column B.

- | | |
|-------------------------------------------------------------------------------------------------------------------------------------------------------|----------------------------------------------------------------------------------------------------------------------------------------------------|
| <p>A</p> <ul style="list-style-type: none"> a. Addition b. Subtraction c. Multiplication d. Division | <p>B</p> <ul style="list-style-type: none"> i. Share ii. Product iii. Increase by iv. Decrease by |
|-------------------------------------------------------------------------------------------------------------------------------------------------------|----------------------------------------------------------------------------------------------------------------------------------------------------|

5. Identify what the person did wrong, when she or he tried to calculate the following?

- a. $489 + 375 = 400 + 300 + 80 + 70 + 9 + 5 = (40 + 5) \times (30 + 6) = (28 \div 4) + (40 \div 40) = 70 + 150 + 14 = 1\,200 + 30 = 1\,530$
- b. $45 \times 36 = 2\,840 \div 40$
- c. $2\,840 \div 40 = (28 \div 4) + (40 \div 40) = 7 + 1 = 8$

6. A greengrocer had 410 oranges. He put some of them into 15 boxes containing 12 oranges each. He then put the rest into 15 boxes, each containing the same number of oranges.

- a. How many oranges were in each of the 15 boxes?
- b. How many oranges were left?
- c. Write a number sentence for the word sum.

Number block

			5	18
3	7			16
	2		3	14
		7		22
19	15	17	19	70

Try to fill in the missing numbers.
 The missing numbers are integers between 0 and 9.
 The numbers in each row add up to totals to the right.
 The numbers in each column add up to the totals along the bottom.
 The diagonal lines also add up the totals to the right.

More properties of numbers

133a

Quick recall. How fast can you answer the following.

$6 \times 9 =$	$5 \times 8 =$	$4 \times 6 =$	$2 \times 6 =$	$8 \times 6 =$	$6 \times 7 =$
$5 \times 7 =$	$2 \times 7 =$	$2 \times 8 =$	$2 \times 9 =$	$8 \times 9 =$	$4 \times 9 =$
$3 \times 9 =$	$7 \times 7 =$	$9 \times 8 =$	$8 \times 7 =$	$9 \times 7 =$	$9 \times 6 =$
$3 \times 6 =$	$5 \times 6 =$	$3 \times 7 =$	$7 \times 9 =$	$4 \times 8 =$	$3 \times 8 =$
$6 \times 8 =$	$5 \times 9 =$	$9 \times 9 =$	$7 \times 6 =$	$4 \times 7 =$	$6 \times 6 =$

1. Determine if the following expressions are equivalent to each other. Insert an = if they are the same and \neq if they are not.

a. $(2 + 5) \times 3$ $(2 \times 3) + (5 \times 3)$

b. $4 - 2$ $2 - 4$

c. $2 + 5 \times 3$ $2 \times 3 + 5 \times 3$

d. 9×8 $9 \div 8$

e. $(10 + 2) \times 4$ $10 + (2 \times 4)$

f. $8 \div 2 + 1$ $(8 \div 2) + 1$

g. $(8 \times 1) + 2$ $(8 + 1) \times 2$

h. $5 + 4 \times 3$ $5 + (4 \times 3)$

i. $5 \times (2 + 4)$ $(5 \times 2) + (5 \times 4)$

j. $72 \div 3 \times 3$ $72 \div 1 (3 \times 3)$

2. Complete the following:

a. $100 \times (30 + 50) = (100 \times 30) + (100 \times 50)$

b. $120 \times (80 + 20) =$

c. $150 \times (30 + 10) =$

d. $20 \times (60 + 30) =$

e. $100 \times (70 + 60) =$

f. Make up your own sum like this:

3. Complete the following:

a. $(1\ 000 \times 2) + (1\ 000 \times 3) = 1\ 000 \times (2 + 3)$

b. $150 \times 10 + 150 \times 50 =$

d. $200 \times 40 + 200 \times 5 =$

e. $17 \times 200 + 17 \times 100 =$

f. $25 \times 40 + 25 \times 300 =$

g. Make up more of your own sums like this:

4. Complete the following:

a. $5 \times (12 + 18) = (5 \times 12) + (5 \times 18)$

$5 \times (30) = 60 + \underline{\hspace{2cm}}$

$150 = \underline{\hspace{2cm}}$

b. $30 \times (40 + 50) = (30 \times 40) + (30 \times 50)$
 $\underline{\hspace{2cm}} = \underline{\hspace{2cm}}$
 $\underline{\hspace{2cm}} = \underline{\hspace{2cm}}$

c. $70 \times (20 + 10)$
 $\underline{\hspace{2cm}} = \underline{\hspace{2cm}}$
 $\underline{\hspace{2cm}} = \underline{\hspace{2cm}}$
 $\underline{\hspace{2cm}} = \underline{\hspace{2cm}}$

d. $(25 + 5) \times 4$
 $\underline{\hspace{2cm}} = \underline{\hspace{2cm}}$
 $\underline{\hspace{2cm}} = \underline{\hspace{2cm}}$

e. $(125 + 25) \times 8$
 $\underline{\hspace{2cm}} = \underline{\hspace{2cm}}$
 $\underline{\hspace{2cm}} = \underline{\hspace{2cm}}$

5. Identify the rule in each case.

a. 225, 250, 275

b. 950, 900, 850

c. 875, 750, 625

d. 14, 39, 64

6. Look at the patterns on the boards. Describe each one in your own words. Write a number sentence for each pattern.

a.

1	2	3	4	5	6	7	8	9	10
11	12	13	14	15	16	17	18	19	20
21	22	23	24	25	26	27	28	29	30
31	32	33	34	35	36	37	38	39	40
41	42	43	44	45	46	47	48	49	50
51	52	53	54	55	56	57	58	59	60
61	62	63	64	65	66	67	68	69	70
71	72	73	74	75	76	77	78	79	80
81	82	83	84	85	86	87	88	89	90
91	92	93	94	95	96	97	98	99	100

b.

1	2	3	4	5	6	7	8	9	10
11	12	13	14	15	16	17	18	19	20
21	22	23	24	25	26	27	28	29	30
31	32	33	34	35	36	37	38	39	40
41	42	43	44	45	46	47	48	49	50
51	52	53	54	55	56	57	58	59	60
61	62	63	64	65	66	67	68	69	70
71	72	73	74	75	76	77	78	79	80
81	82	83	84	85	86	87	88	89	90
91	92	93	94	95	96	97	98	99	100

c.

1	2	3	4	5	6	7	8	9	10
11	12	13	14	15	16	17	18	19	20
21	22	23	24	25	26	27	28	29	30
31	32	33	34	35	36	37	38	39	40
41	42	43	44	45	46	47	48	49	50
51	52	53	54	55	56	57	58	59	60
61	62	63	64	65	66	67	68	69	70
71	72	73	74	75	76	77	78	79	80
81	82	83	84	85	86	87	88	89	90
91	92	93	94	95	96	97	98	99	100

Term 4

Blank writing area for describing patterns.

Solve this Sudoku puzzle

- Each block of 9 squares must have all the numbers 1 to 9.
- Each horizontal row must have all the numbers 1 to 9.
- Each vertical column must have all the numbers 1 to 9.

2	4	1						
		5	3	6				7
			9		4			
9		4				1		
6	5		1			7	4	
	2				8			9
				9		5		
5	2	3	1					
				4	1			2

134a Even more properties of numbers

Quick recall. How fast can you answer the following:

- 6 x 90 = 50 x 80 = 400 x 6 = 20 x 6 = 80 x 60 = 600 x 7 =
- 500 x 7 = 2 x 700 = 20 x 80 = 20 x 9 = 8 x 900 = 40 x 90 =
- 30 x 9 = 7 x 70 = 9 x 800 = 8 x 70 = 900 x 7 = 900 x 6 =
- 3 x 60 = 50 x 60 = 300 x 7 = 7 x 900 = 40 x 80 = 3 x 800 =
- 60 x 80 = 500 x 9 = 90 x 90 = 700 x 6 = 4 x 700 = 60 x 60 =

1. What is the value of ?

- a. $400 + 500 = \square + 400$
- b. $\square + 300 = 300 + 200$
- c. $200 \times \square = 300 \times 200$
- d. $500 \times 600 = \square \times 600$
- e. $(1\,000 + 500) + 2 = 1\,000 + (500 + \square)$
- f. $3(400 + 500) = 3 \times \square + 3 \times 500$
- g. $(500 \times 10) \times 20 = 500 \times (10 \times \square)$
- h. $7(\square - 600) = 7 \times 200 + 7 \times 600$
- i. $(300 + 50) \times 2 = 300 \times \square + 50 \times 2$

Term 4



2. What is the value of ?

- a. + 2 000 = 2 000 + 8 000
- b. $10\,000 \times 8 = 8 \times \img alt="apple icon" style="vertical-align: middle;"/>$
- c. $(250 + 750) + 500 = \img alt="apple icon" style="vertical-align: middle;"/> + (250 + 750)$
- d. $(150 \times 3) \times 10 = 150 \times (\img alt="apple icon" style="vertical-align: middle;"/> \times 10)$
- e. $(740 + 10) \times 20 = 740 \times \img alt="apple icon" style="vertical-align: middle;"/> + 10 \times \img alt="apple icon" style="vertical-align: middle;"/>$

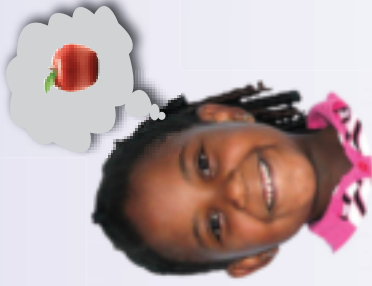

3. What is the value of **a** ?

- a. **a** + 725 = 725 + 567
- b. $825 \times 100 = 100 \times \bfa$
- c. $(350 + 250) + 10\,000 = 350 + (250 + \bfa)$
- d. $(10 \times 1\,200) \times 400 = \bfa \times (1\,200 \times 400)$
- e. $(1\,250 + 750) \times 10 = 1\,250 \times \bfa + 750 \times \bfa$

continued

Even more properties of numbers

continued

134b

3. Calculate the following: $a = 1\ 000$

- a. $a + 50\ 000 = 50\ 000 + a$
=
- b. $a \times 20 = 20 \times a$
=
- c. $(a + 40\ 000) + 500 = a + (40\ 000 + 500)$
=
=
- d. $(a \times 50) \times 2 = a \times (50 \times 2)$
=
=
- e. $(a + 25) \times 3 = (a \times 3) + (25 \times 3)$
=
=
- f. $a \times 0 = 0 \times a$
=
=

4. Calculate the following: $a = 50$ $b = 100$ $c = 2$

- a. $a + b = b + a$
=
=
- b. $a \times b = b \times a$
=
=
- c. $(a + b) + c = a + (b + c)$
=
=
- d. $(a \times b) \times c = a \times (b \times c)$
=
=
- e. $(a + b) \times c = a \times c + b \times c$
=
=
- f. $a \times b \times c = c \times b \times a$
=
=

6. Five patterns (each a different colour) are shown in this 10 x table number board. Write a number sentence for each pattern.

1	2	3	4	5	6	7	8	9	10	
1	1	2	3	4	5	6	7	8	9	10
2	2	4	6	8	10	12	14	16	18	20
3	3	6	9	12	15	18	21	24	27	30
4	4	8	12	16	20	24	28	32	36	40
5	5	10	15	20	25	30	35	40	45	50
6	6	12	18	24	30	36	42	48	54	60
7	7	14	21	28	35	42	49	56	63	70
8	8	16	24	32	40	48	56	64	72	80
9	9	18	27	36	45	54	63	72	81	90
10	10	20	30	40	50	60	70	80	90	100

Solve this Sudoku puzzle

- Each block of 9 squares must have all the numbers 1 to 9.
- Each horizontal row must have all the numbers 1 to 9.
- Each vertical column must have all the numbers 1 to 9.

1		8				6	5	
			9	1			2	
	8			5	7	9		
							9	
5	3	4		1	7			
	4							
5	2	9			3			
	9	7	5					
7	6		2					5

Properties of numbers again

Quick recall. How fast can you answer the following:

- $40 \times 50 =$ $400 \times 90 =$ $5\,000 \times 6 =$ $70 \times 60 =$ $900 \times 60 =$
- $600 \times 80 =$ $11 \times 400 =$ $200 \times 90 =$ $20 \times 30 =$ $80 \times 500 =$
- $20 \times 120 =$ $80 \times 60 =$ $40 \times 800 =$ $80 \times 110 =$ $800 \times 70 =$
- $90 \times 80 =$ $700 \times 120 =$ $2\,000 \times 7 =$ $80 \times 900 =$ $400 \times 40 =$
- $50 \times 700 =$ $400 \times 80 =$ $900 \times 120 =$ $500 \times 60 =$ $70 \times 700 =$

1. What is the value of **X** ?

- a. $8\,000 + 3\,000 =$ **X** + $8\,000$ **X** =
- b. $4\,000 \times$ **X** = $9\,00 \times 4\,000$ **X** =
- c. $(1\,000 + 7\,000) + 50 = 1\,000 + (7\,000 +$ **X**) **X** =
- d. $(4\,000 \times 200) \times 100 = 4\,000 \times (200 \times$ **X**) **X** =
- e. $(9\,000 + 500) \times 10 = 9\,000 \times$ **X** + $500 \times$ **X** **X** =

2. Calculate the following:

- a. $a + 100\,000 = 100\,000 + a$ **a** = **2000**
= b. $a \times 50 = 50 \times a$
=
- c. $(a + 90\,000) + 100\,000 = a + (90\,000 + 100\,000)$
=
=
- d. $(a \times 60) \times 3 = a \times (60 \times 3)$
=
=
- e. $(a + 40) \times 5 = (a \times 5) + (40 \times 5)$
=
=

3. Calculate the following:

- a** = **500** **b** = **300** **c** = **20**
- a. $a + b = b + a$
=
=
=
- b. $a \times b = b \times a$
=
=
=
- c. $(a + b) + c = a + (b + c)$
=
=
=
- d. $(a \times b) \times c = a \times (b \times c)$
=
=
=
- e. $(a + b) \times c = (a \times c) + (b \times c)$
=
=
=

4. Calculate the following:

- x** = **700** **y** = **100** **z** = **40**
- a. $x + y = y + x$
=
=
=
- b. $y \times z = z \times y$
=
=
=
- c. $(x + y) + z = x + (y + z)$
=
=
=
- d. $(x \times y) \times z = x \times (y \times z)$
=
=
=
- e. $(x + y) \times z = (x \times z) + (y \times z)$
=
=
=

Solve the Sudoku puzzle

5	4	2	9			1
		5				4
		7		9		
8			3		6	7
			6	5		
9	3		1			2
			1		6	
2						
3			1	7	4	9

Transformations: reflection, rotation and translation

136

Revise reflection, rotation and translation by describing the diagram.

This is the original shape

This is the reflected shape

This is the original shape

This is the rotated shape

This is the original shape

This is the translated shape

Words that might help you to describe the transformations.

mirror, shape, original shape, line of reflection, and vertical

rotated or turned, clockwise, anti-clockwise, point of rotation, and distance

shape, slide, one place to another, no turning, left, right, up, down,

1. In the first example above, the shape is **reflected** over a vertical line of reflection. Describe the lines of reflection in the following diagram.

a. _____

b. _____

c. _____

d. Describe the **reflection** between the dark yellow and the light blue shape. Draw the line of reflection.

2. The blue shape in second example in the introduction was **rotated 90° clockwise**. Describe the following rotations:

a. _____

b. _____

c. _____

3. The orange shape in the third example in the introduction is **translated one block to the left and one block up**. Look at the diagram in question 2 and describe the **translation** of the following:

a. The dark blue shape to the light green shape.

b. Translate the light blue shape 4 blocks down and 3 blocks to the left. Make a drawing.

4. Look at the diagram in question 2 and describe the following:

a. The light green shape was reflected and translated to the dark yellow shape.

b. The dark yellow shape was reflected and translated to the light blue shape.

Pentominoes and other shapes

a. Can you work out why the set of twelve shapes are called pentominoes.
b. Why can I not use the diagram on the right to describe translation, reflection and rotation?



Figure: _____

Date: _____

What can you tell about these animals? Make up a short story.

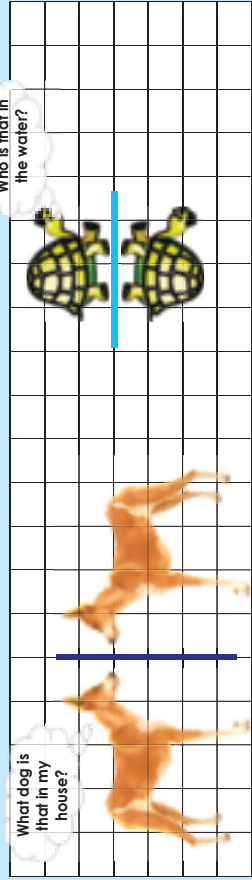

1. Draw the reflection line for each pair.

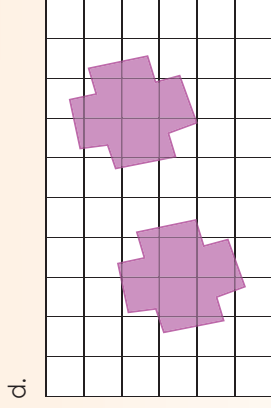
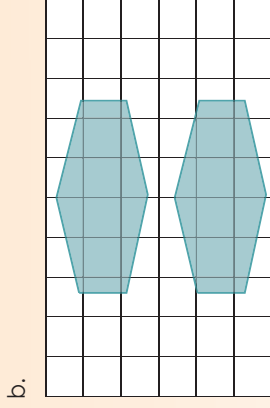
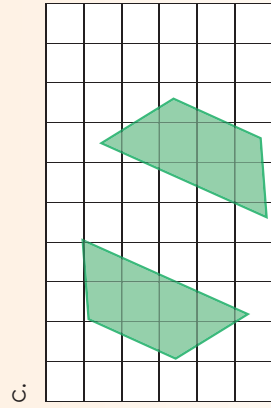
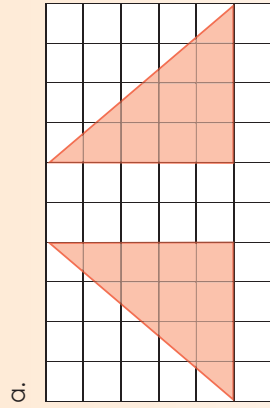

2. Draw the reflection image for each.

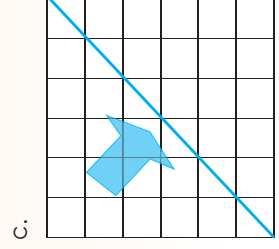
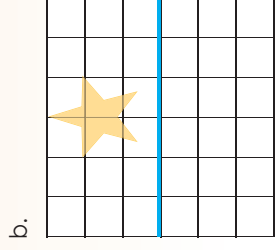
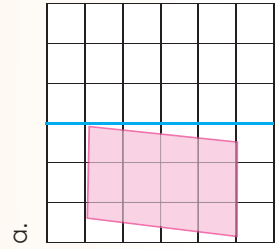

3. Draw the reflection of each figure, then write the coordinate of each new figure.

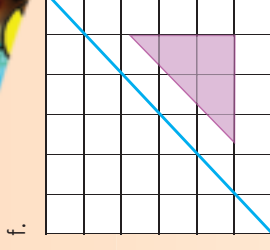
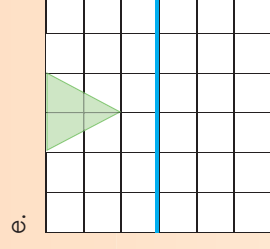
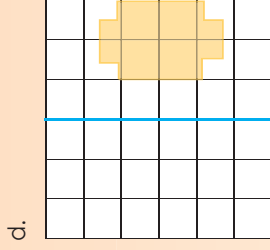

a. Triangle: (2,6); (2,1); (7,1)

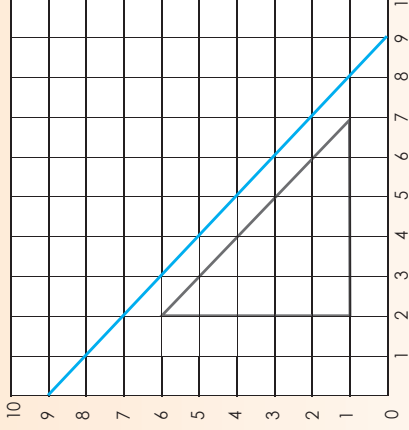

b. Triangle: (5,8); (1,5); (5,2)

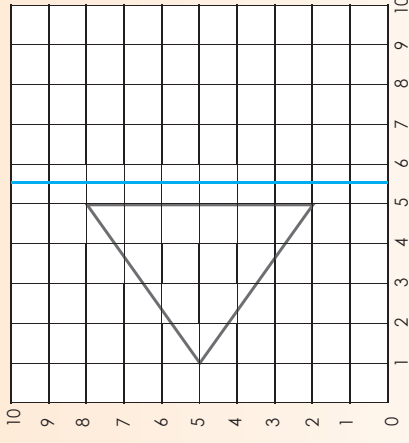

An art pattern

Identify the reflections in this pattern.

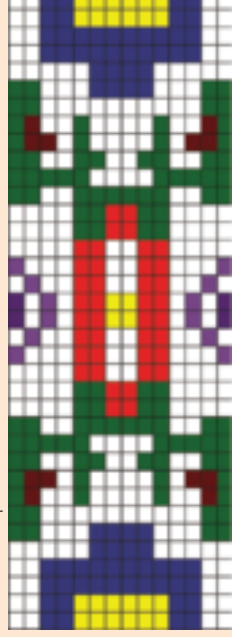

Reflection

137b

Why do we say the line of reflection is like looking in a mirror?

Remember previously we learned about the line of symmetry.

1. Look at these images. Label the "line of reflection" or the "line of symmetry".

a.	b.	c.
d.	e.	f.

2. We can have a horizontal reflection or a vertical reflection. Look at the examples and then answer the questions.

The direction of the movement determines the name.

Horizontal reflection (flips across)

Vertical reflection (flips up/down)

- Draw the line of reflection.
- Say if the reflection is horizontal or vertical.

a.	b.	c.
d.	e.	f.

3. Draw four figures, two showing horizontal reflection and two showing vertical reflection.

a.	b.	
d.	e.	

My computer and flip



You are busy drawing a picture with a computer.
You want to make a mirror image of your picture.
You look at this menu on the computer. Explain what the bottom two instructions mean.
You can make a drawing while you explain it.

What happens to the arrow? Make use of fractions to explain your answer.

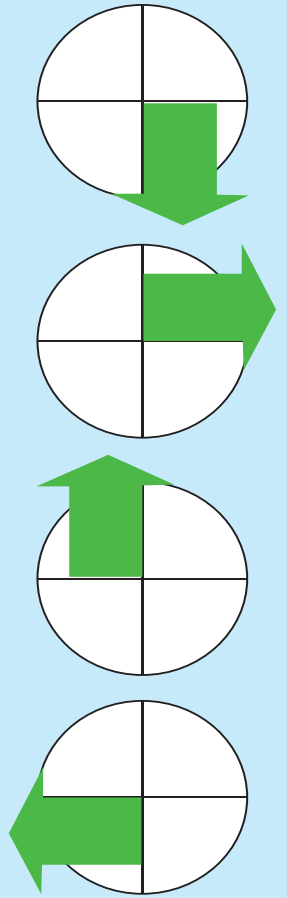

1. Say if it is a half or quarter turn of each image.

a.

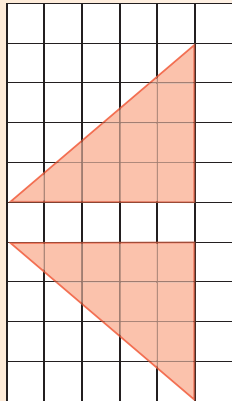

c.

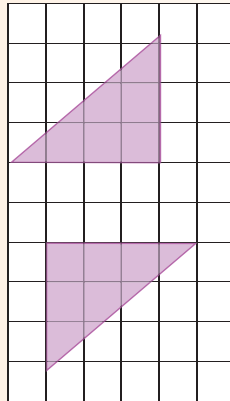

b.

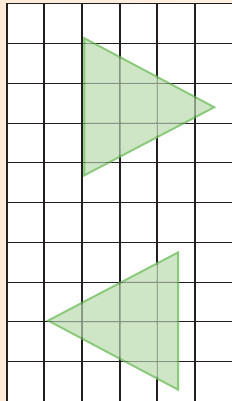

d.

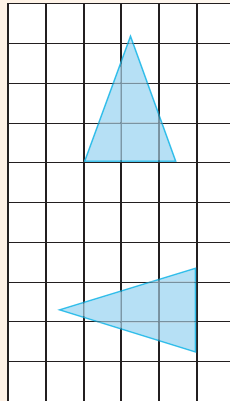

2. Draw a $\frac{1}{2}$ turn for each image.

a.

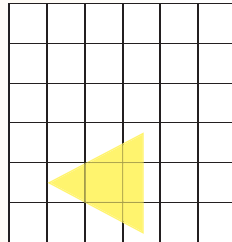

c.

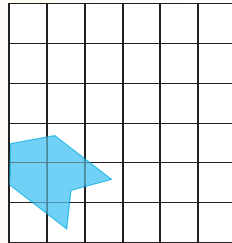

b.

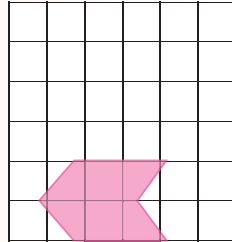

3. Draw a $\frac{1}{4}$ turn for each image.

a.

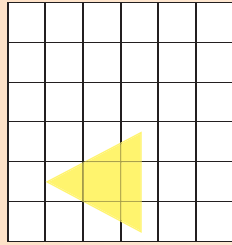

b.

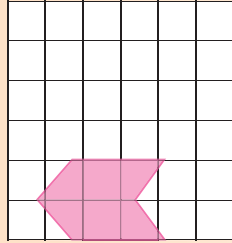

c.

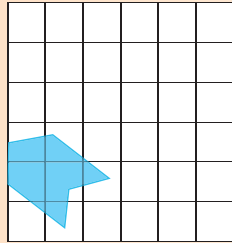

4a. Draw a $\frac{1}{2}$ turn image of the figure:
Triangle: (2,6); (2,1); (7,1)

$\frac{1}{4}$

4c. Draw a $\frac{1}{4}$ turn of the figure:
Triangle: (5,8); (1,5); (5,2)

4b. Write down the new coordinates.

4d. Write down the new coordinates.

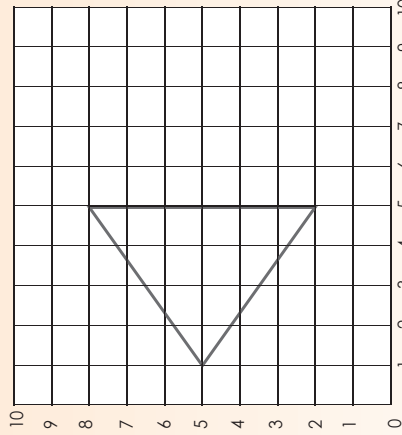
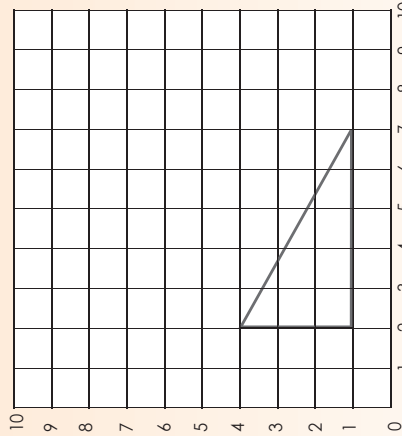

Geometric patterns

Describe each rotation.

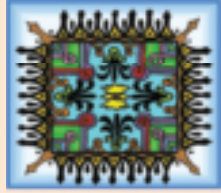

Describe what the rectangle does on this grid.

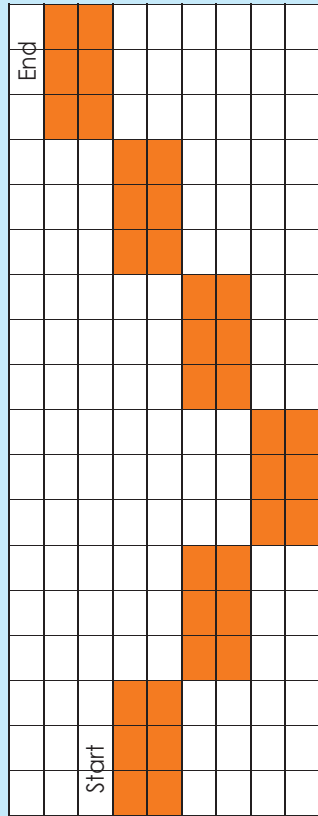

1. Complete the sentences.

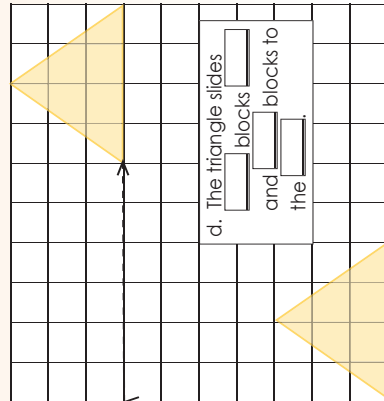
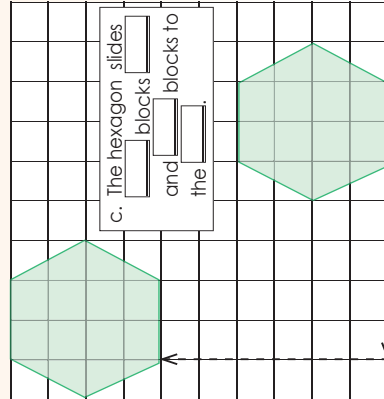
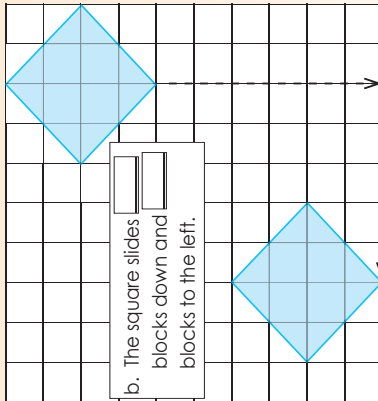
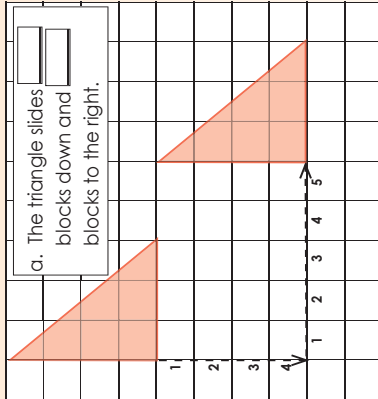

2. Draw the slide image of each figure.

a. 2 down, 4 right

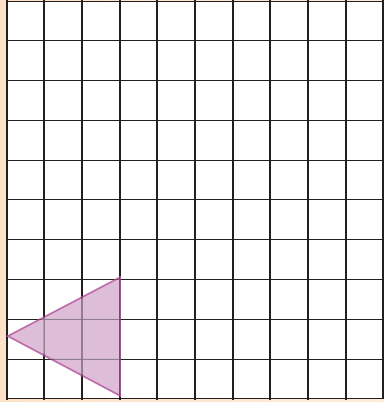

b. 5 left, 2 up

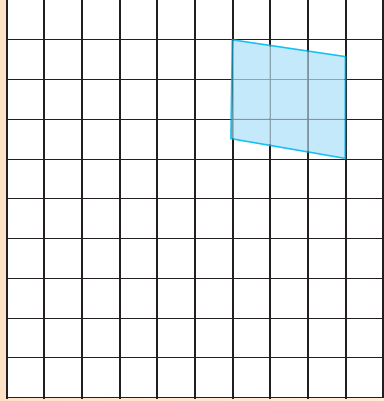

3. Plot the given points, then connect the points in order. Draw each slide, then give the coordinates of the slide image.

a. (2,4); (2,2); (4,2)
Slide 4 right, 4 up

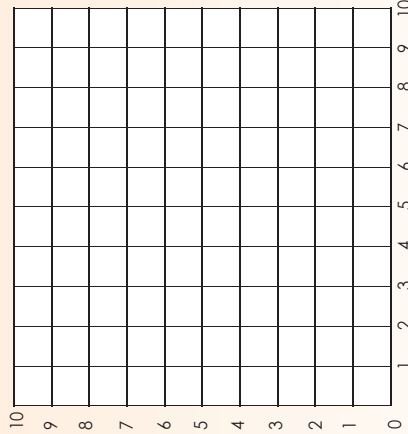

b. (9,9); (6,8); (6,5); (9,5)
Slide 3 down and 2 left

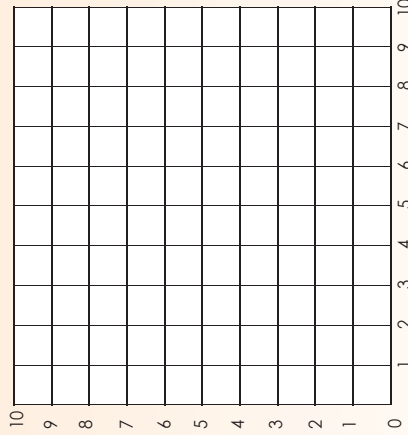

Create a dance.

Create your own dance moves using sliding.

Say if the shape has been flipped, turned or slid.

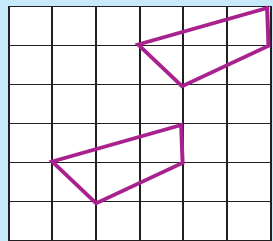
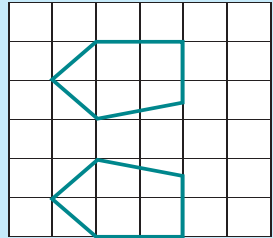
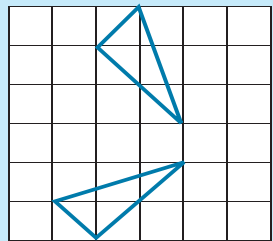

1. Here is a combination of motions. Describe it.

a. Use the dotted shapes, arrows and colours to help you.

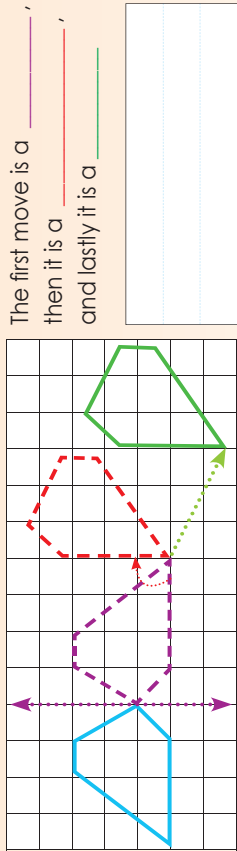

The first move is a _____
 then it is a _____
 and lastly it is a _____

b. Use the dotted shapes and arrows to help you.

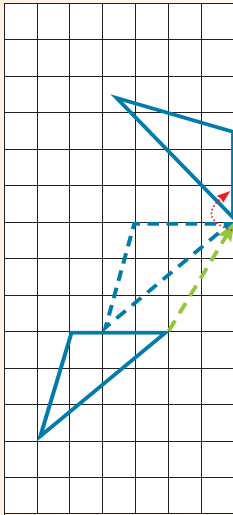

c. Use the dotted shapes to help you. Draw your own arrows to show the motion.

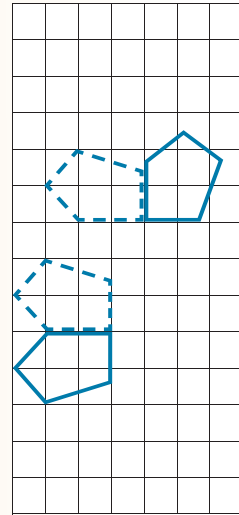

d. Draw your own dotted shapes and arrows to help you to describe the motion.

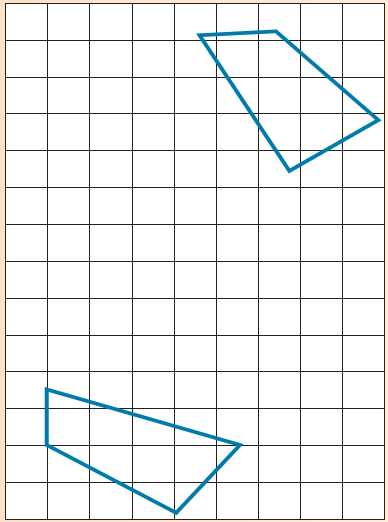

2. Flip, slide and turn the shapes.

a.

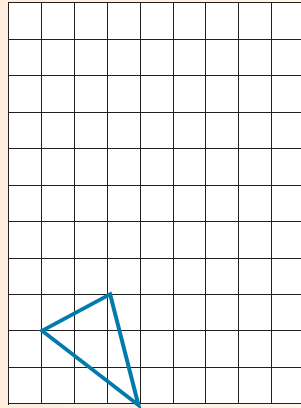
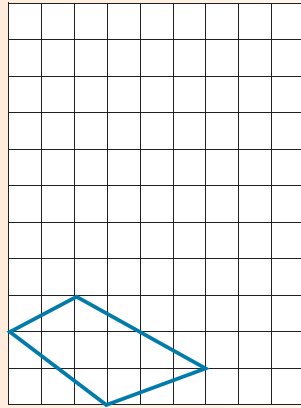

b.

I am an architect.

Play in pairs.

Each player chooses a shape and traces around it.

Player 2 turns away, and then player 1 flips, slides or turns his or her shape and traces it again.

Player 2 now tries to identify the movement of the traced shape.

If she or he identifies the movement correctly he or she gets 1 point.

Repeat with player 1 turning away.

The first person to get 5 points is the winner.

Trace these blocks on cardboard and cut them out.

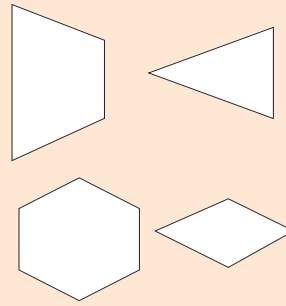

Design your own tangram.



1. Before your answer the questions do it practically with your tangram pieces.

a. Describe the transformations used to create a rectangle from a square.

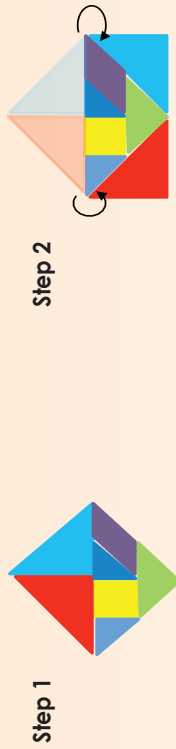

d. Describe the transformations used to create a triangle from a square.



e. Describe the transformation used to create a square using a triangle.



f. Compare the trapezium in b. with the trapezium in c.

b. Describe the transformations used to create a parallelogram from a trapezium.



c. Describe the transformations used to create a trapezium from a triangle



Pentominoes and other shapes

Describe this pattern using transformations below. Draw a picture to illustrate each transformation.



Rotation

Translations

Reflection

Position on a map grid

Did you ever see something like this?

What is it?

How do you use it?

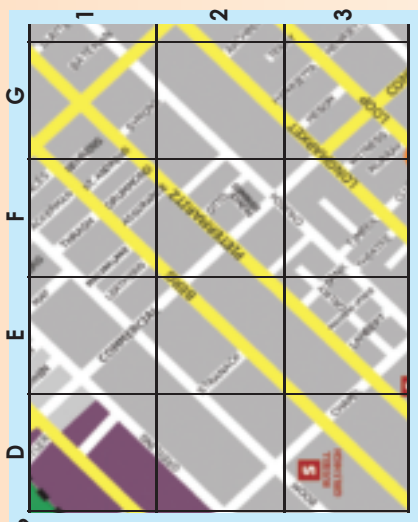

1. How quick can you do this? Colour in the coordinates. What does it spell?

	A	B	C	D	E	F	G	H	I	J	K
1											
2											
3											
4											
5											
6											
7											
8											
9											
10											

- a. A1, A2, A3, A4, B1, C1, C2, C3, C4, D1, E1, E2, E3 and E4.
- b. H1, H2, H3, H4, I1, J1, K1, K2, K3, K4, I3 and J3.
- c. A6, B6, C6, B7, B8, B9, and B10.
- d. E6, E7, E8, E9, E10, F8, G6, G7, G8, G9, and G10.
- e. I6, I7, I8, J6, K6, J8, K8, K9, I10, J10 en K10.

2. Where are the shapes?

a. square

b. rectangle

c. triangle

d. circle

e. pentagon

f. hexagon

g. octagon

h. trapezium

i. parallelogram

3. Describe the route above.

Start at the red square move 8 grid blocks east,

.....

.....

.....

.....

.....

Play battleships ...

How to play using cut-out 7:

- First decide where to place your own fleet of ships within your grid. A fleet is made up of the ships shown to the right of the grid. Each ship is drawn vertically or horizontally (not diagonally). Your ships cannot occupy the same square (i.e. they cannot overlap).
- To place a ship, check how many boxes are covered by the ship (shown to the right of your grid) and then write the first letter of the name of the ship in the boxes it covers. For example, a Cruiser covers three boxes so you would pick any three adjacent boxes and put the letter C in each box. Keep your fleet location secret from your opponent! When each player has marked their fleet on their grid, begin play.
- Take turns to "shoot" at your opponents' fleet by calling out the number of a certain box by its grid location (e.g. "B4" or "D1"). Your opponent must say whether the shot is a "miss" or a "hit", and, if it is a "hit", what type of ship it is. If you hit your opponent's ship it is sunk. You can keep track of what you have shot on your lower grid, and the ships you have sunk by crossing off the ships at the bottom right of your card.
- Play continues until one player wins by successfully sinking the whole of the other player's fleet.

Perspective

142a

From where are you looking at these buildings.

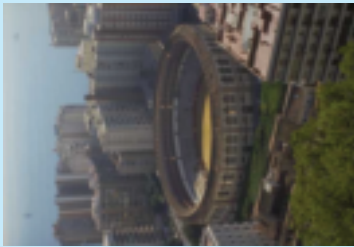

1. What do you notice when you look at these pictures?

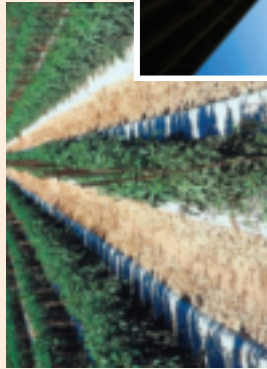

Blank lined writing area for question 1.

2. What do you notice when you look at the photograph and the drawing?

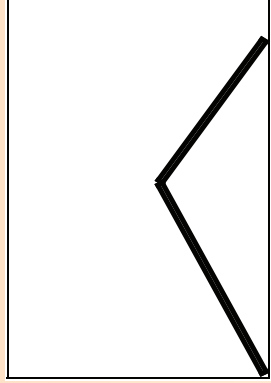
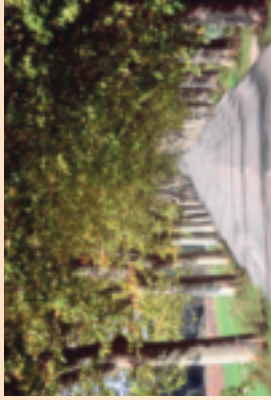

Large blank lined writing area for question 2.

3. Find more photographs in magazines like the ones in question 2.

Perspective continued

142b

4. Put the pictures in the correct order, from furthest to closest.

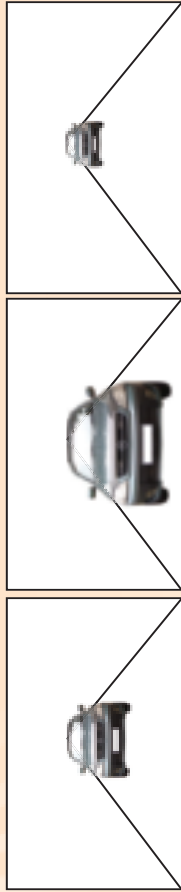

5. Look at the picture and answer the questions below.

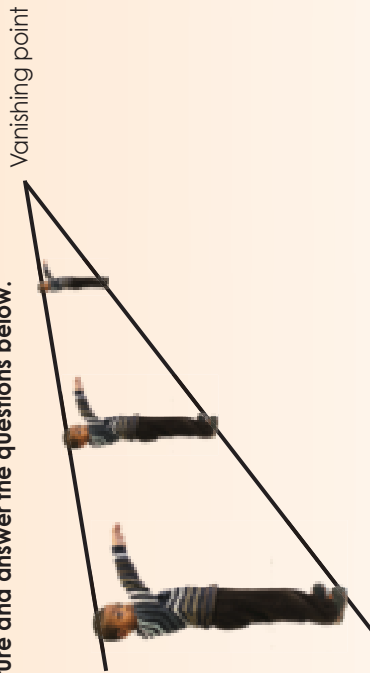

a. What happens to your view of the boy?

b. What do you think vanishing point means?

6. Use Cut-out 8. Cut out the dogs.

Draw perspective lines and put the dogs between the lines as they would look if they were getting further away.

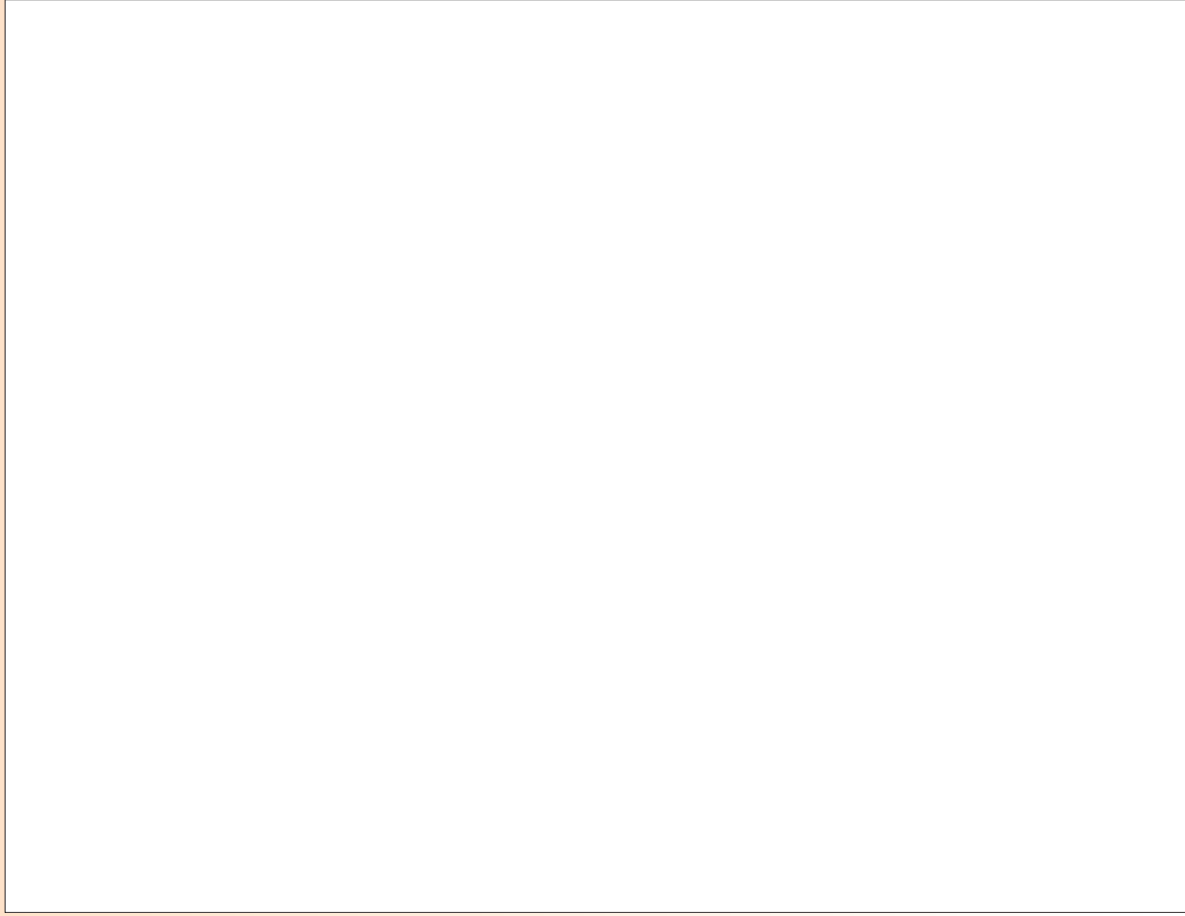

Outcomes of two dice

Draw and make.

Draw these two nets on thick paper or card board, cut, fold and stick together with sticky tape.

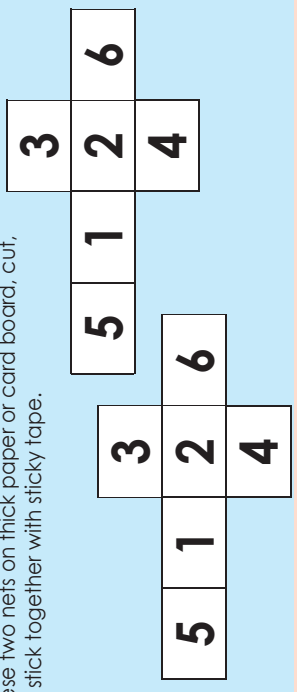

1. Roll one die 100 times. Make use of tallies to record your answers.

Number on the die	Times landed on the number.
1	
2	
3	
4	
5	
6	

2. Compare your answers with those of your friend. Are they the same? Why?

.....

.....

.....

3. Rolling a 3 on a die has a probability of $\frac{1}{6}$ out of 6. We can write it as $\frac{1}{6}$.

- a. What is the probability of rolling a 1?
- b. What is the probability of rolling a 2?
- c. What is the probability of rolling a 4?
- d. What is the probability of rolling a 5?
- e. What is the probability of rolling a 6?

4. Roll two dice 100 times. Make use of tallies to record your answers.

Number on the dice	Times landed on the number.
1	
2	
3	
4	
5	
6	

5. What will happen if you use 3 dice? What is the probability of rolling a:

- 1? 2? 3? 4? 5? 6?

6. a. If you use a dice like this and all the numbers are multiples of 100, what will the other numbers be?

b. What would the probability be to land on each number?

Dice fun

If you a dice like this what is the probability of rolling a 1 or a 3?

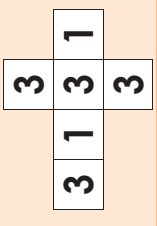

Outcomes of two cards

You need to prepare.
You need to make a set of 10 cards using card board or paper. Each card should be 4 cm by 4 cm.



You need an empty bag.

1	2	3	4	5
6	7	8	9	10

Cut out the ten cards and place it in the bag or box.

1. Draw a card from the bag and record it below. Place the card back into the bag. Do this 100 times.

Number on the card	Times the number was drawn
1	
2	
3	
4	
5	
6	
7	
8	
9	
10	

2. Compare your answers with those of your friend. Are they the same? Why?

.....

.....

.....

.....

.....

3. Drawing a number 5 card from the bag has a probability of 1 out of 10. We can write it as $\frac{1}{10}$.

What is the probability drawing card 1? , card 2? , card 3? , card 4? , card 6? , card 7? , card 8? , card 9? and card 10?

4. Draw two cards from the bag and record it below. Place the cards back into the bag. Do this 100 times.

Number on the card	Times the number was drawn
1	
2	
3	
4	
5	
6	
7	
8	
9	
10	

What is the probability drawing card 1? , card 2? , card 3? , card 4? , card 5? , card 6? , card 7? , card 8? , card 9? and card 10?

5. What will happen if I draw 3 cards at a time? What is the probability of drawing:

1? , 2? , 3? ,
4? , 5? , 6?

Card fun

Do a similar activity but use the following cards.